



MASTER PLAN FOR WATER AND SEWERAGE, 2015 AMENDMENT



TABLE OF CONTENTS

LIST OF EXHIBITS..... iv

LIST OF TABLESv

LIST OF FIGURES vi

CHAPTER 1 – OBJECTIVES AND ORGANIZATION..... 1-1

1.1 Requirements..... 1-1

1.2 Objectives..... 1-2

1.3 Planned Service Area 1-3

 A. Existing and Under Construction Priority..... 1-5

 B. Zero to Five Year Priority..... 1-6

 C. Six to Ten Year Priority..... 1-8

 D. Comprehensive Priority 1-8

 E. Parks and Open Space..... 1-10

1.4 No Planned Service Area 1-10

 A. Shared Sewage Disposal Facility..... 1-11

 B. Existing and Under Construction Priority Area 1-12

 C. Zero to Five Year Priority Area 1-12

 D. No Planned Service Priority Area..... 1-12

1.5 Allocation of Water and Sewer Capacity 1-13

1.6 Extension of the Water or Sewerage System by Capital Projects 1-13

1.7 Private Individual Water and Sewerage Systems..... 1-13

 A. Public Community Water or Sewerage System is “adequate and available”..... 1-14

 B. Public Community Water or Sewerage System will be “adequate and available” within a Two Year Period 1-14

 C. Public Community Water or Sewerage System will be “adequate and available” within a Five Year Period 1-15

 D. Public Community Water or Sewerage System will be “adequate and available” beyond a Five Year Period 1-15

 E. Individual Water Supply and Sewer Systems on Lots of Three (3) Acres or More..... 1-15

 F. Private Multi-User Water and Sewerage Systems 1-16

1.8 Reclaimed Water System..... 1-17

1.9 History 1-18

1.10 Organization 1-19

1.11 Master Plan Review Process – Triennial Amendments..... 1-20

1.12 Master Plan Review Process – Semiannual Amendments 1-21

1.13 Growth Management 1-22

1.14 Metropolitan District Entry Procedure 1-22

1.15 Subdivision Plan Review Process 1-23

 A. Environmental Concept Plan 1-24

 B. Sketch Plan 1-24

 C. Preliminary Plan 1-26

 D. Preliminary Equivalent Sketch Plan 1-26

 E. Final Subdivision Plan and Final Plat 1-27

 F. Site Development Plan..... 1-28

1.16 Capacity Allocation Program 1-28

CHAPTER 2 – HOWARD COUNTY PROFILE AND GENERAL DATA 2-1

2.1 General..... 2-1

2.2 Natural Resources 2-1

2.3 Population 2-3

2.4 Land Use 2-3

CHAPTER 3 – THE WATER PLAN..... 3-1

3.1 Water Requirements..... 3-1

3.2 Existing Water Supply Facilities..... 3-2

3.3 Howard County’s Existing Water System 3-3

 A. 300 Pressure Zone..... 3-3

 B. 350 Pressure Zone..... 3-3

 C. 400 Pressure Zone..... 3-3

 D. 550 Pressure Zone..... 3-4

 E. 560 Pressure Zone..... 3-4

 F. 630 East Pressure Zone 3-4

 G. 630 West Pressure Zone 3-5

 H. 630 South Pressure Zone 3-5

 I. 730 Pressure Zone..... 3-5

 J. Water Service Priority Categories 3-5

3.4 City of Baltimore Supply 3-6

3.5 WSSC Supply 3-9

3.6 Future Construction..... 3-11

3.7 Groundwater Supply 3-13

3.8 Other Supply 3-16

3.9 Water System Hydraulic Modeling 3-17

3.10 Required Local System Improvements.....	3-20
A. 300 Pressure Zone.....	3-20
B. 350 Pressure Zone.....	3-20
C. 400 Pressure Zone.....	3-21
D. 550 Pressure Zone.....	3-22
E. 560 Pressure Zone.....	3-23
F. 630 East Pressure Zone.....	3-23
G. 630 West Pressure Zone.....	3-23
H. 630 South Pressure Zone.....	3-25
I. 730 Pressure Zone.....	3-25
3.11 Water Quality Modeling.....	3-26
A. 350 Pressure Zone.....	3-26
B. 400 Pressure Zone.....	3-26
C. 550 Pressure Zone.....	3-27
D. 630 East Pressure Zone.....	3-27
E. 630 West Pressure Zone.....	3-27
F. 630 South Pressure Zone.....	3-28
G. 730 Pressure Zone.....	3-28
H. Summary.....	3-29
3.12 Water Sampling Results.....	3-29
3.13 Financing Water Improvements.....	3-30
A. Ad Valorem Assessment.....	3-30
B. Front Foot Benefit Assessment.....	3-30
C. Water House Connection Fees.....	3-30
D. Water Service Charges.....	3-31
E. Waster In-Aid-of-Construction Charge (IACC).....	3-31
F. Other Sources of Water System Funds.....	3-32
CHAPTER 4 – THE SEWERAGE PLAN.....	4-1
4.1 General.....	4-1
4.2 Sewerage Collection & Treatment Requirements.....	4-1
A. Pre-Treatment Program.....	4-3
B. Sewer Service Priority Categories.....	4-4
4.3 Consent Agreement.....	4-5
4.4 Sewage Disposal – Private Systems.....	4-6
4.5 Shared Sewage Disposal Systems.....	4-7
4.6 Sewage Conveyance and Treatment – Patapsco Basin.....	4-9
4.7 Sewage Conveyance and Treatment – Patuxent Basin.....	4-14
4.8 Deep Run Water Reclamation Plant.....	4-18
4.9 Sanitary Sewerage System Hydraulic Modeling for Capacity Evaluation.....	4-18
4.10 Required Local System Improvements.....	4-21
A. Little Patuxent Sewer Drainage Area- South of MD Route 108.....	4-21
B. Route 108 Sewage Pumping Station Drainage Area- North of MD Route 108.....	4-21
C. Middle Patuxent Sewer Drainage Area.....	4-22

D. Hammond Branch Sewer Drainage Area.....	4-22
E. North Laurel Sewer Drainage Area	4-23
F. Guilford Run Sewer Drainage Area.....	4-23
G. Dorsey Run Sewer Drainage Area.....	4-24
H. Bonnie Branch and Rockburn Branch Sewer Drainage Areas.....	4-24
I. Tiber Branch Sewer Drainage Area.....	4-24
J. Sucker Branch Sewer Drainage Area.....	4-25
K. Deep Run Interceptor Sewer Drainage Area	4-25
L. Shallow Run Sewer Drainage Area	4-26
M. Sewer Pumping Station Improvements.....	4-26
4.11 Biosolids & Residual Solids Processing & Disposal.....	4-27
4.12 Reclaimed Water System	4-29
4.13 Septage Collection and Treatment	4-30
A. Historical Loadings at the LPWRP Septage Receiving Facility	4-31
B. Anticipated Loadings.....	4-33
4.14 Financing Sewerage Improvements	4-33
A. Ad Valorem Assessment.....	4-34
B. Front Foot Benefit Assessment.....	4-34
C. Sewer In-Aid-of-Construction Charge (IACC).....	4-34
D. Sewer House Connection Fees.....	4-35
E. Sewer User Charges and Surcharges	4-35
F. Reclaimed Water User Charges	4-36
G. Operation and Maintenance Fee, Shared Sewage Disposal Systems.....	4-36
H. Other Sources of Sewerage System Funds	4-36
4.15 Financial Management Plan	4-38

LIST OF EXHIBITS

EXHIBIT 1:	WATER FACILITIES PLAN Map and Table of Service Priority Revisions 2011- 2014
EXHIBIT 2:	SEWER FACILITIES PLAN Map and Table of Service Priority Revisions 2011- 2014
EXHIBIT 3:	1986 Baltimore City–Howard County Water Agreement
EXHIBIT 4:	1988 WSSC–Howard County Water Agreement
EXHIBIT 5:	2014 Water Quality Report & Sampling Data
EXHIBIT 6:	Baltimore County–Howard County Sewer Agreement
EXHIBIT 7:	Anne Arundel–Howard County Sewer Agreement
EXHIBIT 8:	Patapsco Service Area Memorandum of Understanding
EXHIBIT 9:	NPDES LPWRP Discharge Permit
EXHIBIT 10:	Water Resources Element April 2010
EXHIBIT 11:	Reclaimed Water Management (RWM) Plan
EXHIBIT 12:	Howard County Topographic Map
EXHIBIT 13:	Howard County PlanHoward 2030 Map

LIST OF TABLES

Chapter 2 (the Tables follow Page 2-4)

- Table 1: Household Population Projections for Public Water Service
- Table 1A: Development of Non-Residential Acreage for Public Water Service
- Table 1B: Household Population Projections for Public Sewer Service
- Table 1C: Development of Non-Residential Acreage for Public Sewer Service
- Table 1D: Redevelopment Cumulative Area
- Table 2: Land Use in Howard County
- Table 2A: Estimated Enrollment/Population of Schools and Institutions in Howard County - 2014

Chapter 3 (the Tables follow Page 3-32)

- Table 3: Projected Water Demands and Planned Capacity
- Table 3A: Average Daily Water Demand
- Table 3B: Projected Average Daily Demand and Contracted Average Daily Supply
- Table 4: Inventory of Existing Multi-Use and Community Well and Surface Water Supply
- Table 5: Inventory of Existing Impounded Water Supplies
- Table 6: Inventory of Existing Water Treatment Facilities
- Table 6A: Public Water Storage Facilities
- Table 6B: Water Pumping Stations
- Table 7: Inventory of Ground Water Problem Areas
- Table 8: Immediate, 5-Year, 10-Year and Comprehensive Priorities for Water System Development

Chapter 4 (the Tables follow Page FS-3)

- Table 9: Projected Sewer Flows and Capacities
- Table 9A: Flow Projections by Drainage Area
- Table 10: Inventory of Existing Wastewater Treatment Plants
- Table 10A: Summary of Existing and Planned Permit Discharges
- Table 10B: Existing and Proposed Shared Septic Systems
- Table 10C: Summary of Existing and Planned Community Septic Systems
- Table 11: Problem Areas Inventory - Individual and Community
- Table 12: Omitted
- Table 13: Immediate, 5-Year, 10-Year & Comprehensive Priorities for Sewer System Development
- Table 14: Omitted
- Table 15: Flow Monitoring Data - Wastewater Treatment Plants
- Table 15A: Flow Analysis Data
- Table 16: Sewage Sludge Generation
- Table 16A: Sludge Treatment and Disposal
- Table 17: Sewer Pumping Stations
- Table 18: Immediate, 5-Year, 10-Year & Comprehensive Priorities for Reclaimed Water System Development

LIST OF FIGURES

Chapter 1 (the Figures follow Page 1-30)

- Figure 1-1: Water and Sewer Facilities Management
- Figure 1-2: Water and Sewer Planning and Grants Administration
- Figure 1-3: Subdivision Plan Review and Capacity Allocation Process
- Figure 1-4: Site Development Plan Review Process and Capacity Allocation Procedure

Chapter 2 (the Figures follow the Chapter 2 Tables)

- Figure 2-1: Howard County Regional Location
- Figure 2-2: Generalized Soils Map
- Figure 2-3: Geology of Howard County
- Figure 2-4: Surface Water Patterns
- Figure 2-5: Stream Use Classifications
- Figure 2-6: Howard County Population Growth 1960-2040
- Figure 2-7: Gross Population Density - 2015
- Figure 2-8: Gross Population Density - 2025
- Figure 2-9: Gross Population Density - 2035
- Figure 2-10: Existing Land Use
- Figure 2-11: Zoning Map
- Figure 2-12: Major Public Institution Location Map

Chapter 3 (the Figures follow the Chapter 3 Tables)

- Figure 3-1: Water System Schematic
- Figure 3-2: Water Pressure Zones
- Figure 3-3: Gross Alpha Radiation Private Well Water Sample
- Figure 3-3A: 226/228 Particle Counts Private Well Water Sampling
- Figure 3-4: Immediate, 5-Year, 10-Year, and Comprehensive Priorities Map for Water System Development

Chapter 4 (the Figures follow the Chapter 4 Tables)

- Figure 4-1: LPWRP Process Schematic
- Figure 4-2: Little Patuxent Water Reclamation Plant (LPWRP)
- Figure 4-3: Immediate, 5-Year, 10-Year & Comprehensive Priorities Map for Sewer System Development

CHAPTER 1

OBJECTIVES AND ORGANIZATION

1.1 Requirements:

Title 9, Subtitle 5 of the Environment Article of the Annotated Code of Maryland requires that Howard County triennially review and adopt a Report of the Review and Amendments to the Master Plan for Water and Sewerage. Responsibility for implementation of Title 9 is assigned to the Maryland Department of the Environment (MDE) in accordance with Code of Maryland Regulation (COMAR) 26.03.01 - Regulations for Planning Water Supply and Sewerage Systems. Howard County Code (Subtitle 1. Public Utilities, Section 18.100A) establishes general procedures for the Howard County Master Plan for Water and Sewerage. Howard County formulated the Master Plan for Water and Sewerage within the framework of these regulations.

"Semiannual Amendments" may also be prepared to amend the Master Plan for Water and Sewerage more frequently than the regulations require. These Semiannual Amendments are prepared in accordance with the Environment Article of the Annotated Code of Maryland and COMAR 26.03.01. Usually, the following types of revisions will be incorporated into the Master Plan for Water and Sewerage through the Semiannual Amendment process:

1. Changes in capital projects related to the Annual Capital Budget, the Ten Year Capital Improvement Program, or completed engineering studies.
2. Entry of properties into the County's Metropolitan District.
3. Changes in service area priorities.
4. Changes in the water and sewer Planned Service Area.

The Maryland Department of the Environment processes construction permit applications for water and sewerage facilities to serve planned development in the Planned Service Area that is expected to be served by public water or sewer within five years, as shown on the facilities maps in Chapters 3 and 4. Permits are issued when all local and state requirements and regulations are satisfied, and adequate system capacity is available.

In accordance with State law, construction permits will only be issued for development that is consistent with this Master Plan. Since construction permits are valid for a three year period, except under special conditions specified in the Plan, the Maryland Department of the Environment interpreted the law to mean that it would be inconsistent with the Plan to issue a permit for development of a property that is not expected to be served by public water or sewer within five years. Before issuance of a construction permit for proposed development of a property designated within the 6-to-10 year or comprehensive service priority areas, where specified special conditions are not applicable, an amendment for the Master Plan for Water and Sewerage must be developed and approved to assign the property a 0-to-5 year service priority designation.

1.2 Objectives:

The Master Plan for Water and Sewerage is prepared with the intent of accomplishing the following objectives:

1. To further the health and welfare of citizens residing and/or working in Howard County through the development of adequate water and sewer systems.
2. To support County development policies including implementation of the General Plan through the timely completion of water and sewer facilities to accommodate future growth.
3. To provide a framework for the scheduling and prioritizing of water and sewer projects based on evaluation of existing facilities usage, public health considerations and projected growth patterns.

In August 2012, Howard County formally adopted PlanHoward 2030 as the General Plan for the County. The Plan was subsequently amended in February 2013 to adopt growth tiers. PlanHoward 2030 is a plan for land use and land conservation with multi-year development plans for transportation, public facilities, water, sewerage, parkland, housing, human services and environmental protection. PlanHoward 2030 is an update to the General Plan 2000 that was adopted in November 2000. Two amendments to General Plan 2000, the Water Resource Element and the Downtown Columbia Plan, are included in PlanHoward 2030 by reference.

Other law, policies, regulations, and planning documents are considered in the triennial update of the Master Plan. These include:

1. Policies relating to inclusion of properties in the Metropolitan District
2. Howard County Code, Title 18, Subtitle 12- Shared Sewage Disposal Facilities
3. Water and Sewer System Capacity Allocation Policy (Section 18.122B of the Howard County Code)
4. Subdivision and Land Development Regulations (Section 16 Subtitle 1 of the Howard County Code)
5. Howard County Plumbing Code
6. Maryland Department of the Environment Regulations (COMAR 26.04.03.02 and .03-Development Plan submission requirements.)

1.3 Planned Service Area

The eastern portion of the County has been delineated as the Planned Service Area (PSA) for public water and sewerage (refer to the Water Facilities Plan Map in EXHIBIT 1, and the Sewer Facilities Plan Map in EXHIBIT 2). This area consists of all properties within the County that have been approved by the Howard County Council to be in the Planned Service Area.

Revisions to the Planned Service Area require amendments to the General Plan. Several amendments to the Planned Service Area have been approved by the County Council following publication of the 2011 Water & Sewer Master Plan. These are described as follows:

1. Council Bill 9-2010 amended the Planned Service Area boundary for water and sewer service to include approximately 221.1 acres of the historic Doughoregan property known as tax map 23, grid 10, part of parcel 71. The parcel is located south of the intersection of Frederick Road and US Route 40, and east of Manor Lane in Ellicott City, Md.

2. PlanHoward 2030 amended the Planned Service Area for sewerage to include twenty properties in the Ellicott City area totaling 158.76 acres and bounded by US Route 40 on the north, Marriottsville Road on the west and Frederick Road to the south. The properties are part of the Alpha Ridge Water Service Area.
3. PlanHoward 2030 amended the Planned Service Area for water and sewerage to add four properties in the Clarksville area totaling 90.33 acres and bounded by Guilford Road on the north and MD Route 108 on the west.
4. PlanHoward 2030 amended the Planned Service Area for water and sewerage to add one property in the Fulton area totaling 91.25 acres and bounded by Scaggsville Road to the north and Murphy Road to the west.

The General Plan provides for expansion of the Planned Service Area under limited circumstances for certain public or institutional uses. Expansion for public or institutional uses must meet criteria limiting the parcel size to the minimum necessary for the proposed institutional use and requiring actual construction of the proposed use and connection to the public system by a specific deadline. Expansion of the PSA for institutional uses is limited to institutional properties that are adjacent to the existing boundary of the PSA and which continue the linear boundary line without including an intervening, privately-owned parcel that is currently not located in the Planned Service Area. Before obtaining public water or sewer service, a property within the PSA must enter the County's Metropolitan District. Property in the Metropolitan District is subject to fees, assessments and charges required to finance the construction, operation and maintenance of the public water and sewerage system.

Parcels of land within the designated “No Planned Service Area” of the Howard County Master Plan for Water & Sewerage are not eligible for connection to the public water and/or sewerage system. However, parcels that have been ordered by the Health Department’s Bureau of Environmental Health to connect to the public system under emergency circumstances are eligible for connection if the public system is available to the property. These parcels will not be incorporated into the Metropolitan District after connection, nor brought into the Planned Service Area. They are subject to the fees, assessments, and charges to finance the construction, operation, and maintenance of the public water and sewerage systems to the same extent as parcels in the Metropolitan District. These connections must be in accordance with section 18.101 of the Howard County Code.

Orderly expansion of the public water and sewer system is controlled through the County's Capital Budget and Ten Year Capital Improvement Program, the Metropolitan District entry process, the subdivision plan review process, and the Water and Sewer Capacity Allocation Program. These processes and programs are more fully described in the following section.

In general, undeveloped properties within the Planned Service Area that are not to be serviced by planned capital projects are to be serviced via Developer Agreements. It is difficult to establish when specific parcels will be developed. Changes in economic conditions and other factors occurring after approval of the Master Plan for Water and Sewerage may result in a developer desiring to service a property at a time earlier than is specified by the Master Plan for Water and Sewerage. Similarly, a developer may desire to construct planned facilities in advance of the County capital project construction schedule. If the proposed development represents an orderly extension of the public water or sewer system and is consistent with the County's General Plan and subdivision regulations, the County grants the service priority change so development can occur. Therefore, service area priorities identified in the Master Plan for Water and Sewerage and associated maps are subject to change as development is proposed within the Metropolitan District. These changes are incorporated in semiannual and regular triennial amendments to the Plan as appropriate and are described below.

As noted under the discussion of the comprehensive priority area, the County shall not accept or approve a proposal to change the priority area designation for the provision of public sewerage service to any parcel in the Alpha Ridge Water Service Area unless sewer service is only being provided for the parcel to serve public facilities, or the General Plan is amended to designate the priority in this area for urban district land uses. Until one of these conditions is met, parcels in the Alpha Ridge Water Service Area shall remain in the comprehensive priority category for sewerage service.

Parcels of property in the Planned Service Area (including lots in a subdivision), are assigned water and sewer service priorities as delineated on the service area maps referenced in Chapters 3 and 4 based on the definitions and criteria described below:

A. Existing and Under Construction Priority

Parcels of land in the existing and under construction service priority area are served by water or sewer lines in operation or under construction (for capital projects a notice to proceed with a contract has been let, for developer projects a developer agreement has been executed), and are expected to be in operation immediately upon completion.

Parcels or lots assigned this service priority must be in the County's Metropolitan District and must meet one of the following three (3) criteria:

1. The parcel is developed, is not likely to be further subdivided, and fronts on an existing water or sewer line to which a house or building connection can be or has been made, or
2. The parcel is not developed, is likely to be developed without further subdivision, and fronts on an existing water or sewer line to which a house or building connection can be made, or
3. The parcel fronts on an existing water or sewer line to which a house or building connection can be made, and
 - a. will likely be developed after a minor subdivision of the parcel, that is, subdivision of the parcel into four or fewer lots not involving construction of a new street, or
 - b. will be developed such that the water demand and wastewater flows generated will not be great enough to warrant separate tracking of the parcel's development status in the Master Plan for Water and Sewerage.

It is assumed in evaluating parcels for inclusion in the existing service priority area that subdivision will occur in conformance with either existing zoning or the General Plan as amended, whichever provides for higher density development.

B. Zero to Five Year Priority

In conformance with direction received from the Maryland Department of the Environment by letter dated November 28, 1984, the previous S-2/W-2 Final Planning Area, S-3/W-3 Immediate Priority Area, and S-4/W-4 Three to Five Year Priority Area specified in COMAR 26.03.01.04.G(2) have been incorporated into a single zero to five (0-5) year service priority area. A parcel assigned this service priority must meet both of the following criteria:

1. Development of the parcel within the zero to five year time frame must be consistent with the General Plan and amendments, and related County policy.

2. In addition to the above, the parcel must meet one of the following four (4) criteria:
 - a. The parcel is divided by or fronts on an existing water or sewer line, or one which will be constructed within a five year period as part of an established capital project, which can provide adequate service when development takes place. The parcel and water or sewer line must be located in the same sewer service area or water pressure zone, or
 - b. The parcel will be subdivided and/or developed by a private party who:
 - (1) Will provide public water or sewer service, and
 - (2) Has submitted a sketch plan, preliminary plan, final subdivision plan or other adequate evidence for a development which is planned to occur within five years, which documents an orderly extension of the public water or sewer system within the sewer service area or water pressure zone in which the parcel is located, or
 - c. The parcel is located within 1,000 feet of the existing water or sewer system which could be extended to provide adequate water or sewer service within the sewer service area or water pressure zone in which the parcel is located. This criteria is based in part on Department of the Environment criteria governing the construction of routine water main and sewer line extensions for which a State construction permit is not required, or
 - d. The parcel is located within 1,000 feet of a portion of the water or sewer system which will be constructed within five years as part of an established capital project in the County's Ten Year Capital Improvement Program and could be further extended to provide adequate water or sewer service within the sewer service area or water pressure zone in which the parcel is located.

Parcels which are not in the County's Metropolitan District but otherwise meet the criteria for inclusion in the existing and under construction priority area are assigned to the 0-5 priority area.

As indicated above, one of the conditions for inclusion in the 0-5 year priority area is that adequate water and sewer facilities must be located within the water pressure zone or

sewer drainage area in which the parcel is located. Boundaries between adjacent drainage areas and zones are not static and may be altered on a temporary or permanent basis (by valves, force mains, etc.) to provide for the needs of parcels adjacent to or divided by these boundaries. Generally, the desirability of relocating a zone or drainage area boundary will be assessed by the Department of Public Works at the time of submission of a sketch plan or other preliminary document which describes provisions for water and sewer service in detail. The desirability of boundary relocations will be assessed on a case-by-case basis considering such factors as conformance of the proposed project with sound engineering practice, the existing and future impact on zones or drainage areas being altered, and the need for an orderly extension of existing facilities.

C. Six to Ten Year Priority

Parcels assigned this service priority must meet the following two (2) criteria:

1. Development of the parcel within the six to ten year time frame must be consistent with the General Plan and amendments.
2. The parcel must be located in a sewer service area or water pressure zone within which the major system components (primarily interceptors and transmission mains) are in place or are planned to be in place within ten years, or

The parcel will be subdivided and developed by a private party who:

- a. Will provide public water and sewer service, and
- b. Has submitted a plan or other adequate evidence for a development which is planned to occur within six to ten years, which documents an orderly extension of the public water or sewer system within the sewer service area and water pressure zone in which the parcel is located.

D. Comprehensive Priority

The comprehensive priority area is for the parcels located in the Planned Water and Sewerage Service Area which are not assigned one of the above service priorities and are not park or open space land. These parcels are designated for service after a ten-year period. Developed parcels located in service areas which will not have the major system components in place within ten years are assigned this service priority. The County will

not initiate capital projects to extend public water and sewer service to these areas for the purpose of promoting private development.

In 1993, the County Council amended the 1990 General Plan for Howard County by extending the Planned Service Area to incorporate certain properties in the Marriottsville Area as shown on Map 1 attached to County Council Resolution 145-1993 and the Map attached to Council Bill 73-1996. The properties added to the Planned Service Area are referred to in this chapter as the Alpha Ridge Water Service Area. The express intent of the amendments to the General Plan was to provide public water service to satisfy residents' concerns about potential groundwater contamination. The effect and intent of the Amendment to the 1990 General Plan were continued in the General Plan 2000 approved in November 2000.

Council bill 18-2006 amended the General Plan to allow for the provision of sewer service within the Alpha Ridge Water Service Area for qualifying parcels under certain conditions. A qualifying parcel is one that is owned either by Howard County Government or the Board of Education of Howard County. The qualifying parcel must adjoin another parcel where sewer service is available. Sewer service to a qualifying parcel may be extended only if sewer service can be extended without making sewer service available to any intervening non-qualifying parcel not owned by the Howard County Government or the Board of Education of Howard County. With the exception of qualifying parcels, the County's intent was also to maintain this service area in the comprehensive priority area for sewer service.

PlanHoward 2030 amended the Planned Service Area to allow for the provision of sewer service to twenty properties within the Alpha Ridge Service Area including parcels owned by the Board of Education.

The comprehensive priority area designation for sewer service shall remain in place unless the General Plan is amended to designate this area for urban district land uses. Until such amendment is approved, the County shall not accept or approve a proposal from a private party to amend the Sewer Service Area priority designation for a parcel in the Alpha Ridge Water Service Area. The only exceptions allowing for the provision of sewer service in the Alpha Ridge Water Service Area are for parcels on which public facilities are located, or for parcels which the Howard County Bureau of Environmental Health orders connected for emergency health reasons. An order for connections by the Health Department can only be implemented if the public sewerage system is available to service the parcel. Availability shall be determined by the Department of Public Works. Any connection made pursuant to Health Department order shall be restricted to the

minimum pipe size necessary to correct the health problems for the existing building (s) in use on the parcel at the time of the Health Department order.

E. Parks and Open Space

Public park land and designated open space areas within the Planned Service Area are separately identified on the water and sewerage maps. Since these properties will not be subdivided for residential or commercial/industrial development, they are not assigned a service priority. However, it is not intended to prevent the extension of water or sewer lines to these properties in the Planned Service Area if such extensions will provide for facilities consistent with the designated land use. For example, water and sewer extensions may be necessary to provide for:

1. Restrooms or other sanitary facilities.
2. Lawn/garden irrigation systems.
3. Potable drinking water supply.

It is intended that such extensions may occur at any time if the property is in the Metropolitan District; the water or sewerage system is adequate to provide the required service; and the project represents an orderly extension of the system. Occasionally, open space areas may be used for other public purposes. For example, possession may be given to the Board of Education as a location for a school. Provision of water and sewer service to such properties is considered in accordance with the intent of this Master Plan for Water and Sewerage provided the development meets all other County development criteria.

1.4 No Planned Service Area

Parcels in the No Planned Service Area will not be provided with public water or sewerage facilities. Shared Sewage Disposal Facilities and Multi-User Sewerage Systems, to the extent provided in the Howard County Code, may be used in the No Planned Service Area as described below. Generally, properties designated in the General Plan as Rural Conservation (RC) or Rural Residential (RR) are assigned to this service area. The associated population densities and land uses can be accommodated by private individual and small grouped systems. The extent of the No Planned Service Area may change if County land use plans, in particular, the General Plan, are revised to recommend land uses which require inclusion of affected properties in the Planned Service Area.

The County will no longer extend the Planned Service Area for RR and RC zoned parcels in order to address public health concerns. Such parcels will be provided with necessary connection to public water and/or sewerage service if, in the opinion of the Director of Public Works, public systems are available and connection to the public system is ordered by the Howard County Bureau of Environmental Health to protect public health and welfare. The parcels will not be included in the Metropolitan District.

The County provided a water main extension into the No Planned Service Area to the West Friendship Fire Station site at the intersection of Rt. 99 and Rt. 32. This main is utilized only for fire suppression at the West Friendship Fire Station site. Individual parcels outside of the Planned Service Area and fronting on this water main will not be allowed to connect.

A. Shared Sewage Disposal Facility

A "Shared Sewage Disposal Facility" means a sewerage system which serves more than one lot of land with public collector sewers, common septic tank and/or advanced pretreatment, and shared subsurface sewage disposal fields.

Undeveloped properties zoned RR and RC within the No Planned Service Area may be serviced by private individual on-site septic systems or shared sewage disposal facilities. Howard County Code Title 18, Subtitle 12, establishes requirements and procedures for shared disposal facilities to serve cluster development permitted on RR and RC zoned land. These systems are proposed and constructed by private developers of residential subdivisions. Shared sewage disposal facilities are designed in accordance with County standards and must be approved by the Department of Public Works, the Department of Planning and Zoning, the Howard County Bureau of Environmental Health and, at their discretion, the Maryland Department of the Environment prior to construction. Shared sewage facilities that require a State Groundwater Discharge Permit issued by the Maryland Department of the Environment are prohibited under Section 18.1202 of the Howard County Code.

Shared sewage disposal facilities generally consist of pumps and controls located on individual parcels which discharge to a common sewer main. The sewer conveys collected sewage to a common pretreatment area consisting of septic tanks and other pretreatment. Treated effluent is discharged to a subsurface soil absorption area. Shared sewage disposal facilities and related easements become County property after construction. Operation and maintenance of shared sewage facilities is the responsibility of the Department of Public Works.

Parcels of land within the No Planned Service Area are assigned sewer service priorities only for shared sewage disposal facilities as delineated on the service area maps referenced in Chapter 4 based on the definitions and criteria described below. It is noted that only three service priorities are provided. Given that a developer's intention to provide a shared sewage disposal facility generally becomes known when development plans are submitted for County review, or as a result of pre-submission consultation, the "Six-to-Ten Year" and "Comprehensive" service priorities utilized within the Planned Service Area are not applicable to the No Planned Service Area.

B. Existing and Under Construction Priority Area

Parcels of land in the existing and under construction service priority area of the No Planned Service Area are served by shared sewage disposal facilities currently in operation, or which are under construction and are expected to be in operation immediately upon completion.

C. Zero to Five Year Priority Area

A parcel assigned this service priority within the No Planned Service Area will be served by a shared sewage disposal system and must meet both of the following criteria:

1. Development of the parcel within the zero to five year time frame must be consistent with the General Plan as amended and related County policy.
2. In addition, the parcel will be subdivided and/or developed by a private party who:
 - a. will provide shared sewage disposal facilities, and
 - b. has submitted a sketch plan, preliminary plan, final subdivision plan or other adequate evidence for a development which is planned to occur within five years.

D. No Planned Service Priority Area

Prior to the submission of development plans or other notification of a developer's intent to construct a shared sewage disposal facility, it is not possible to determine if a shared facility will be provided to service a subdivided property. For this reason, properties in the No Planned Service Area that are not included in one of the two priority areas described above, are simply designated as "no planned service". The "no planned service" priority assigned to a parcel can be revised if use of a shared sewage disposal

facility, in accordance with Title 18, subtitle 12 of the Howard County Code, is proposed in accordance with the criteria described for the "zero to five" year priority area.

1.5 Allocation of Water and Sewer Capacity

Howard County developed and implemented a capacity allocation program to control connections to the public water and sewerage systems in the Planned Service Area. Properties within the Metropolitan District are prioritized as to eligibility for connection in accordance with the requirements of Section 18.122B of the County Code. Regardless of the service area priority assigned to a parcel or subdivision in the Master Plan for Water and Sewerage, a capacity allocation must be granted under Section 18.122B prior to connection to the water or sewer system.

1.6 Extension of the Water or Sewerage System by Capital Projects

Capital Projects in the Planned Service Area are shown in the County's Capital Budget and Ten Year Capital Improvement Program with projected implementation schedules. These projects are also described in Tables 8 and 13 of Chapters 3 and 4, respectively. Interceptors, transmission mains, pumping stations, and storage facilities are identified on the facilities maps included with this plan.

1.7 Private Individual Water and Sewerage Systems

"Individual water supply system" means a single system of piping, pumps, tanks, or other facilities utilizing a source of ground or surface water to supply only a single lot.

"Individual sewerage system" means a single system of sewers and piping, treatment tanks or other facilities serving only a single lot and disposing of sewage or individual wastes of a liquid nature, in whole or in part, on or in the soil of the property, into any waters of this State or by other methods.

"Community sewerage system" means any system, whether publicly or privately owned, serving two or more individual lots, for the collection and disposal of sewage or industrial wastes of a liquid nature, including various devices for the treatment of the sewage and industrial wastes.

"Community water supply system" means a source of water and a distribution system, including treatment and storage facilities, whether publicly or privately owned, serving two or more individual lots.

The installation of public community water and sewerage facilities in the Planned Service Area eliminates the need for private water and sewerage systems in the areas for which public service is or will be provided. However, the implementation of public water and sewerage facilities occurs over several years, necessitating the installation of individual water or sewerage systems for new development where public facilities are not yet available. Installation of individual systems in the Planned Service Area is subject to the following conditions:

A. Public Community Water or Sewerage System is "adequate and available".

An individual water supply or individual sewerage system may not be installed on any parcel or lot where a public community water or sewer system is adequate and available.

An "adequate" public community water or sewerage system is defined as a system in which unused capacity exists for allocation. Adequacy is determined based on an analysis of hydraulic and treatment capacities versus current, allocated, measured and/or estimated use.

An "available" public community water or sewerage system is defined as a system to which a house or building connection can be made in a cost effective manner without excessive extension of the existing public community system. The Department of Public Works will determine whether or not a connection is cost effective or is an excessive extension. The Department of Public Works and the Maryland Department of the Environment are responsible for determining the adequacy of a public community system. In the context of this section of the Master Plan for Water and Sewerage, a public community water or sewerage system is a County owned water or sewerage system.

B. Public Community Water or Sewerage System will be "adequate and available" within a Two Year Period.

Where a parcel or lot will have an adequate public community system (constructed as part of a capital project) available within a two year period, installation of capped water and sewer lines will be required in accordance with County Subdivision Regulations, Section 16.131. Lines are constructed after execution of an appropriate Developer Agreement with Howard County. The final subdivision plat must include a statement

that the subdivision may only utilize interim individual water and sewerage systems for a maximum period of one (1) year after public water and sewer become available. Capacity will be reserved through the established allocation program for these subdivisions.

C. Public Community Water or Sewerage System will be “adequate and available” within a Five Year Period.

Interim individual water supply and interim individual sewer systems may be permitted to be installed on any parcel or lot which will have an adequate public community system (constructed as part of a capital project) available within a five year period provided that:

1. Permits for such interim individual systems bear a notice regarding the interim nature of the permit and stating that connection to a future public community system shall be made within one year after the public community system becomes “available”,
2. Such interim individual systems are judged by the local Health Department, Bureau of Environmental Health and Department of Public Works to be adequate, safe, and in compliance with pertinent state and local regulations, including minimum lot ownership as set forth in COMAR 26.04.03.03, and
3. Such individual systems are located to allow future connections to the public community system in the most economical and convenient manner.

D. Public Community Water or Sewerage System will be “adequate and available” beyond a Five Year Period.

Individual water supply or individual sewer systems, not of an interim nature, shall be permitted to be installed on any parcel or lot which will not have an adequate public community system (constructed as part of a capital project) available within a five-year period. Such installations shall be governed by COMAR 26.04.03.02 and .03 as minimum requirements.

E. Individual Water Supply and Sewer Systems on Lots of Three (3) Acres or More.

Within the Planned Service Area, regardless of when an “adequate” community water and/or sewer system will be available, if the minimum lot size is three (3) acres a developer may utilize permanent on-site water supply and individual sewer systems.

F. Private Multi-User Water and Sewerage Systems.

A "multi-user sewerage system" means a single system serving a single lot, whether owned or operated by an individual or group of individuals under private or collective ownership, and serving a group of individuals for the collection and disposal of sewage or industrial wastes of a liquid nature, including various devices, if any, for the treatment of sewage and industrial wastes, having a treatment capacity in excess of 5,000 gallons per day.

A "multi-user water supply system" means a single system of piping, pumps, tanks, or other facilities utilizing a source of ground or surface water to supply a group of individuals on a single lot and having a capacity in excess of 1,500 gallons per day, as defined by COMAR 26.03.01.01

Multi-user sewerage systems which include devices for the treatment of sewage will not be permitted to serve any properties located within the Planned Service Area. In addition, residential multi-user water supply systems will not be permitted within the Planned Service Area. Multi-user Sewerage Systems located outside the Planned Service Area are regulated by the Maryland Department of the Environment and the Health Department, and under certain circumstances and in a limited capacity, as defined in Title 18, Subtitle 12, of the Howard County Code, may be subject to oversight responsibilities by the Department of Public Works.

Private multi-user sewerage pumping systems used to convey sewage to the public sewerage system, which typically consist of privately owned and constructed pumping station, force main and outfall used to provide sewer service to non-residential properties for which gravity service from the public sewerage system is not available, will be permitted if the following conditions are met:

1. The sewage pumping station, force main, and property served must be owned, operated and maintained by a single property owner.
2. Pumped sewer service is allowable only if gravity service is not available in a cost effective manner as determined by the Department of Public Works.
3. Capacity for the pumped (diverted) sewage flow must be available in the receiving area above the currently projected needs of the receiving area.
4. The discharge force main must terminate in a manhole located on the property served. The gravity outfall sewer must be able to connect to an

existing gravity sewer without the need to acquire additional public rights-of-way. Existing public rights-of-way may be used. However, any construction within a public right-of-way will become a public utility owned and operated by Howard County Department of Public Works. Any such construction must meet County standards and be approved by the County. The length of sewer in a public right-of-way which will not become a permanent part of the public sewerage system when the private pumping station is abandoned shall be minimized. All designs of private multi-user sewerage pumping systems shall take into account odor mitigation at the point of discharge, and protection of existing public gravity sewer mains from hydrogen sulfide deterioration.

5. The private pumping station must be abandoned when gravity sewer service becomes available to the property. The pumping station must be located such that future gravity service will be easily accessed.
6. The owner of the pumped system, which is a private system, is required to obtain all relevant permits, including plumbing permits, building permits, etc.

Privately owned pumping stations which serve more than one property are considered as private community systems. These systems are subject to the same criteria as private multi-user sewerage pumping systems as well as the additional requirements below:

7. The owner of the pumping station must submit to the Maryland Department of the Environment assurances in the form of legal documents that the facility will be maintained and operated so as to provide continuous acceptable sewage disposal service to the properties served.
8. The pumping station owner shall submit to the Maryland Department of the Environment evidence that a certified Class II System Operator (or a contracted utility service utilizing certified operators) has been hired to operate the pumping station.

1.8 Reclaimed Water System

Howard County's Bureau of Utilities has taken initiatives toward implementing a County-wide reclaimed water distribution network to utilize highly-treated effluent produced by the Little Patuxent Water Reclamation Plant to satisfy water demands for

non-potable use. In June 2014, the County completed preparation of two planning documents for reclaimed water development: the “Conceptual Reclaimed Water System Master Plan” and the “Reclaimed Water Management (RWM) Plan”.

The “Conceptual Reclaimed Water System Master Plan” provides a concept for development of a reclaimed water distribution system including a conceptual layout and staging plan for the system. The “Reclaimed Water Management (RWM) Plan” is a supplement to the Master Plan and provides additional detail regarding reclaimed water production and treatment, transmission and distribution, market and customer development, monitoring and reporting, and public health and safety controls. Refer to Chapter 4 for additional detail.

1.9 History

In 1931, under special Maryland legislation, the Elkridge area was created as a special sanitary district, enabling the expansion of the Baltimore City water system to the area in order to relieve shortages of water. In 1943, with other areas of the County experiencing similar problems, the Maryland General Assembly authorized the formation of the Howard County Metropolitan Commission, which would have the authority to create sanitary districts. Each district was governed by the Commission which was responsible for construction, maintenance and operation of water, sewerage and drainage facilities.

In 1948, the Metropolitan Commission created the Elkridge Sub-District which included the old sanitary district. Five years later the Patuxent Sub-District was formed on petition from residents of that area. Agreement with the Washington Suburban Sanitary Commission provided the water supply to the Patuxent Sub-District. The Commission extended the Patuxent Sub-District to include the Savage area in 1955. With this extension the Commission purchased the existing local water and sewerage facilities previously constructed by the Savage Manufacturing Company. A year later the Commission took over the maintenance of the water mains in the Elkridge Sub-District previously maintained by Baltimore City. During 1957 the Commission created the Ellicott City Sub-District and obtained water from Baltimore City to serve that area.

With the increase in residential development partially due to an adequate water supply, the Commission recognized the growing problems of sewage disposal and authorized the preparation of a comprehensive master plan report for the collection and disposal of sewage. As a result of this report and subsequent supplementary financial analyses, the Commission proceeded to develop plans and construct sewerage facilities in those areas

over which it had jurisdiction. In 1964 the Commission prepared and adopted its first 5-Year Capital Improvements and Planning Objectives Program.

The Maryland General Assembly passed an act in 1965 under which the existing five Howard County Sub-Districts were combined into one sanitary district called the Metropolitan District. This single sanitary district greatly simplified the Commission's financial and administrative responsibilities.

In 1966 the Commission presented its second five-year capital improvement program and its third in 1968. These Five Year Program reports provided primary guidance in the planning and development of water and sewer services for the County.

1.10 Organization

When Howard County established the Charter form of government in 1969, the Metropolitan Commission was abolished and all administrative duties were transferred to the Executive Branch of government with specific responsibility assigned to the Department of Public Works. The Bureau of Engineering is charged with the design of water and sewerage facilities and with overseeing the construction and inspection of water and sewer projects. Operation and maintenance of water distribution, wastewater collection, and wastewater treatment facilities is the responsibility of the Bureau of Utilities. The Bureau of Utilities is also responsible for water and sewage system planning, including preparation of this Master Plan. Organizational charts are shown in **Figures 1-1 and 1-2**, which are provided at the end of this Chapter.

Citizen review is provided through several Boards. The Public Works Board, which is composed of five members appointed by the County Executive and approved by the County Council, makes recommendations to the Executive and to the County Council on planning and on policy matters under the jurisdiction of the Department of Public Works. The Planning Board, which is also composed of five members appointed by the County Executive and approved by the County Council, makes recommendations to the Executive and to the County Council on planning and on policy matters under the jurisdiction of the Department of Planning and Zoning. The Public Works Board and Planning Board review regular triennial amendments to the Master Plan for Water and Sewerage and make comments to the County Executive and County Council.

The legislative duties of the Metropolitan Commission were transferred to the County Council. The County Council has the following responsibilities:

1. Acts on legislative incorporations of properties requesting to be included into the Metropolitan District.
2. Annually reviews and approves water and sewerage system capital improvements as part of the Capital Budget.
3. Annually reviews and approves water and sewer rates, fees, and assessments through the budgetary process.
4. Approves regular triennial and semi-annual Master Plan amendments.

During the Fall of each year, the Department of Public Works solicits public input to assist with future planning for the extension of water and sewer facilities. This public input, in addition to other public requests received during the year, and data developed by the County Health Department, Bureau of Environmental Health and the Department of Public Works, is taken into consideration before water and sewer projects are proposed for inclusion in the Annual Capital Budget and the Ten Year Capital Improvement Program and which are in turn included in the Master Plan.

1.11 Master Plan Review Process - Triennial Amendments

State regulations require a review of the Master Plan for Water and Sewerage at least once every three years. The review and approval process utilized by the County is outlined below:

1. The Plan is reviewed and a preliminary draft amendment comprising all proposed revisions is developed by the Department of Public Works, Bureau of Utilities. The preliminary draft amendment is circulated to each County agency affected by its contents, including the Department of Planning and Zoning, Health Department, Bureau of Environmental Health, and other Bureaus within the Department of Public Works. The draft is also submitted to the Maryland Department of the Environment, Department of Natural Resources, and Department of State Planning for preliminary review. After revision based on comments received, a final draft is submitted to the Planning Board and Public Works Board for review.
2. Public meetings, preceded by printing of a public notice, are held with both the Planning Board and the Public Works Board. The Boards'

recommendations are incorporated into Department of Public Works testimony to the County Council.

3. The final draft is submitted to the County Council for consideration during an appropriate legislative session.
4. A public hearing, preceded by two printings of a public notice, is held by the County Council after which further revisions may be made. The Plan amendment is then formally approved by the County Council.
5. The locally approved amendment is submitted to the Maryland Department of the Environment for approval.
6. Following notification of State approval, the Plan amendment is reproduced and distributed in final form.

1.12 Master Plan Review Process - Semiannual Amendments

Semiannual Amendments to the Master Plan are developed more frequently than triennial amendments. Several types of revisions, as described on Page 1-1, are usually incorporated into the Master Plan by Semiannual Amendment. The review and approval process utilized by the County is outlined below:

1. The Plan is reviewed and the preliminary draft amendment comprising all proposed revisions is developed by the Department of Public Works, Bureau of Utilities in cooperation with the Bureau of Engineering and Department of Planning and Zoning. The preliminary draft amendment is circulated to each County agency affected by its contents, including the Department of Planning and Zoning, County Health Department, Bureau of Environmental Health, and other Bureaus within the Department of Public Works. Comments received are considered in the preparation of a final draft.
2. The final draft is submitted to the County Council for consideration during an appropriate legislative session.
3. A public hearing, preceded by two printings of a public notice, is held by the County Council after which further revisions may be made. The Plan amendment is then formally approved by the County Council.

4. The locally approved amendment is submitted to the State Department of the Environment.
5. Following notification of State approval, the Plan amendment is reproduced and distributed in final form.

1.13 Growth Management

Development in the County, both outside and within the Planned Service Area, must be in accordance with the approved General Plan and Comprehensive Zoning Plan. Changes in zoning for a given property must be approved by the Zoning Board which is comprised of the members of the County Council. When reviewing petitions filed by property owners for zoning changes, the Zoning Board considers the comments of County departments and agencies. The Department of Public Works provides information on the “availability and adequacy” of public water and sewerage facilities. The Board rules on zoning petitions considering, in addition to other information, the water and sewer data provided by the Department. To insure that growth occurs as specified by approved Plans, an extensive plan review and permit system has been established. Several elements of this system are designed to manage expansion and ensure orderly extension of public water and sewer facilities. These elements are described in the remainder of this chapter.

The maintenance of water quality within the County’s existing watersheds is given a high priority in the management of growth and development. As certain Tier II waterways have been identified within the Planned Service Area (PSA) for water and sewerage, intense watershed planning is necessary to insure continued protection of such high quality waters. Those waterways identified as Tier II by the Maryland Department of the Environment are given special consideration as outlined in the 2010 Water Resources Element (WRE), which is included as an appendix to the Plan. Particular attention should be paid to the section on “Water Quality in Local Streams” beginning on Page 28 of the WRE. PlanHoward 2030 further addresses growth management within these areas.

1.14 Metropolitan District Entry Procedure

To establish eligibility for water and sewerage service, properties must gain entry into the Metropolitan District unless the Health Department, Bureau of Environmental Health, has ordered connection due to emergency circumstances. The Metropolitan District was established as a special assessment district to finance water and sewerage services.

Public water and sewerage service is restricted by the Howard County Code to properties in the District which pay an annual benefit assessment to fund construction of system improvements and extensions (see sections on Financing Water Improvements and Financing Sewerage Improvements, Chapters 3 and 4). Once a property is accepted into the District, extension of the public water and sewerage systems to provide service is controlled through the subdivision review and permit process, or the water and sewer Capital Improvement Program, and through the capacity allocation program.

The procedures of incorporating a property into the Metropolitan District are established by the Howard County Code (Subtitle 1. Public Utilities, Sec. 18.101. Metropolitan District; Creation; Incorporation of Additional Property. A property located in the Planned Service Area under the definition by this Plan is eligible for entering the Metropolitan District in one of three ways. They are outlined as follows:

1. Administrative Incorporation,
2. Legislative Incorporation, or
3. Emergency Incorporation.

Entry of the property into the Metropolitan District must be accomplished before service can be provided either by a capital project or private developer.

1.15 Subdivision Plan Review Process

The subdivision review and approval process, outlined below, is graphically illustrated on **Figure 1-3**, which is included at the end of this chapter.

Property owners may develop land in the County in accordance with the General Plan as adopted by the County Council, which is the basis for the Zoning Map and Zoning Regulations as adopted by the Zoning Board. The subdivision and development of land must be in accordance with Subdivision and Land Development Regulations which are adopted and periodically amended by the County Council. The Department of Planning and Zoning administers the Subdivision and Land Development Regulations with the assistance of County and State agencies, including the Department of Public Works, which provides comments on submitted plans. In cases where strict adherence to the Subdivision Regulations imposes extraordinary hardship or practical difficulty, a land owner or developer may petition the Department of Planning and Zoning for a waiver to relax the minimum requirements. However, the intent of the Regulations must be maintained.

The review of subdivision and land development plans may be completed by one of two submission processes: the Standard Plan Submission process and the Alternate Plan Submission process. The Standard Plan Submission process consists of Sketch (S) Plan, Preliminary (P) Plan, Final (F) Subdivision Plan and plat, and Site Development Plan (SDP) review stages. For the Alternate Plan Submission process, the Sketch Plan and Preliminary Plan stages are replaced by a single Preliminary Equivalent Sketch (SP) Plan review stage in which the sketch plan and preliminary plans are combined in a single submission.

In addition to the above processes, an Environmental Concept Plan (ECP) is required for submission with the sketch plan or preliminary equivalent sketch plan prior to the submission of site development plans and minor subdivision/re-subdivision final plans. Each review stage is described below.

A. Environmental Concept Plan

The Environmental Concept Plan is the first of three required plan approvals that provides the information necessary to allow an initial evaluation of a proposed project. The ECP includes a conceptual design for storm water management, erosion and sediment control and the delineation of environmental features. Pre-submission of an ECP to the Department of Planning & Zoning is required for proposed storm water management facilities to demonstrate that the environmental site design is achieved to the maximum extent practicable.

B. Sketch Plan

The primary purpose of the sketch plan is to inform the County of a developer's intent to develop property. The plan must show the proposed development density, road network, lot sizes and other pertinent factors in a non-detailed format. Copies of the sketch plan are circulated to the reviewing agencies. At this stage, the developer indicates a desire to either connect to the public water and/or sewer system, to construct on-site facilities, or shared sewage disposal facilities (in accordance with Title 18, Subtitle 12 of the Howard County Code). The Development Engineering Division of the Department of Planning and Zoning conducts a preliminary review to determine the status of public water and sewer service for the proposed development. Factors considered include Metropolitan District status, hydraulic capacity, existing system alignment, and status of future capital projects to serve the area. Proposed development for which adequate water/sewer facilities are available will normally be required by the Department of Public Works to connect to the public system(s).

Where adequate capacity is not available or where the existing public system alignment makes connection infeasible, individual or multi-user systems may be acceptable. These systems are subject to approval by the County Health Department, Bureau of Environmental Health, in conformance with COMAR 26.04.03.02 and .03. Criteria and requirements for the use of these systems were detailed previously in the Private Individual Water and Sewerage Systems section of this chapter.

For properties which are scheduled for public service within 0 to 2 years, Section 16.131 of the County Code requires that the developer install capped water and sewer lines to serve the property or subdivision after public service becomes available. Prior to the availability of public service, the proposed development may be constructed with private systems if approved by the County Health Department, Bureau of Environmental Health. If the approval of the Bureau of Environmental Health cannot be attained, development must be delayed until public water and/or sewer can be provided. As an alternative, the developer may be allowed to enter into a Developer Agreement with the County and fund extension of the existing public system to the property.

A Developer Agreement would be executed by the County only if adequate public system capacity is available at the time the development is proposed, and the construction represents an orderly extension of existing facilities.

For properties not scheduled for service by a Capital Project within two years, sketch plans are reviewed by the Development Engineering Division to determine the feasibility of extending the public system by means of a Developer Agreement. A Developer Agreement would be acceptable if adequate capacity is available at the time development is proposed and an orderly system extension would result. In lieu of a public system extension, private systems may be installed subject to County Health Department, Bureau of Environmental Health approval as previously discussed. In cases where a Capital Project will be constructed to serve the proposed development after two years but within five years, connection to the public system would be required within one year after the system is available. Where a Capital Project will not be constructed within five years, a private system may be considered permanent unless failures make connection to an adequate public system necessary.

For RC and RR zoned properties within the No Planned Service Area for which shared sewage disposal facilities are proposed, the plan must delineate existing and proposed individual wells, individual septic systems, and the proposed shared sewage disposal facilities.

After meeting with the developer and reviewing all recommendations, the Department of Planning and Zoning must correspond with a developer within sixty (60) days of application, indicating approval, approval with modifications, or denial of the sketch plan.

C. Preliminary Plan

The purpose of the preliminary plan is to present a plan showing detailed data based on the approved sketch plan, which will enable the County to determine whether the proposed layout is satisfactory, and fulfills the detailed requirements of applicable regulations. The preliminary plan, sealed and signed by a registered engineer or other person qualified by law and licensed in Maryland, is submitted to the Department of Planning and Zoning. As with the sketch plan, distribution is made to the reviewing agencies. These plans include proposed alignment and sizing of public water and sewer systems, when on-site systems are not being installed, or where capped systems are required. In cases where shared sewage disposal facilities are proposed for cluster subdivisions, the shared facilities along with the results of soil percolation tests and the locations of water wells are to be indicated on the plans. Review by the Department of Public Works is conducted to insure that the proposed utility design meets established County standards.

Within sixty (60) days after formal plan submittal, the Department of Planning and Zoning must take action on the plan and communicate same to the developer.

D. Preliminary Equivalent Sketch Plan

The purpose of the preliminary equivalent sketch plan is to provide an alternate plan process that includes all the information normally required with both the sketch and preliminary plan submission on one plan. The preliminary plan stage may be omitted if a developer selects the preliminary equivalent sketch plan process in lieu of the separate sketch and preliminary plan submissions.

The plan review process and capacity allocation procedures for the preliminary equivalent sketch plan are similar to those described herein for the sketch and preliminary plans. The preliminary equivalent sketch plan is sealed and signed by a registered engineer or other person qualified by law and licensed in the State of Maryland.

The Department of Planning and Zoning must take action on the plan and communicate same to the developer within sixty (60) days after the formal plan submittal. Upon

approval of the preliminary equivalent sketch plan, the developer would proceed directly to the final plan submission process.

E. Final Subdivision Plan and Final Plat

The final subdivision plan must be submitted to the Department of Planning and Zoning within the required adequate public facilities milestone date of 4, 6, or 9 months as specified in Section 16.144 of the Subdivision and Land Development Regulations. The submission includes copies of a final plat which will become the official record of the subdivision of land within a development and construction drawings which are distributed for comments. The Department of Public Works reviews the construction drawings to insure that design and construction standards are met.

All subdivision plats must also receive approval by the Bureau of Environmental Health of the County Health Department in accordance with the County Subdivision Regulations, Section 16.144 of the County Code.

Where private systems or shared sewage disposal facilities are to be installed, final plans must be in conformance with State and County Health Department regulations and a shared sewage disposal facility plan shall be submitted to receive Department of Public Works, Bureau of Utilities approval in accordance with Section 18 of the Howard County Code. Within sixty (60) days after final plan approval by the Department of Planning and Zoning, the developer must submit the original construction drawings (roads, storm drainage, water, and sewer) for signatures after which the final plat is approved. The final plat must delineate all access and maintenance easements for shared sewage disposal facilities. A temporary allocation of water and/or sewer capacity is granted at the time of final plat approval for development in the Planned Service Area. This allocation is held for one hundred eighty (180) days during which time the developer must execute a Developer Agreement for water, sewer and/or shared sewage disposal facilities and for roads and storm drains. If the Developer Agreement for water and/or sewer is not executed within this time period, then the allocation becomes void unless an extension is granted.

Upon execution of the Developer Agreement, the allocation is formally granted to the property in accordance with the provisions of the agreement. A prerequisite to the execution a Developer Agreement is the posting of a performance bond with the County by the developer to ensure the facilities construction. After execution of appropriate Developer Agreements, and within 180 days after final plan approval, the final plat is recorded in the Land Records of Howard County which allows the legal sale of each lot. In cases where a property owner wished to create four (4) or fewer lots, known as a minor

subdivision, only a final plat is required in the subdivision process. In this case, review of the final plat is conducted to determine the adequacy of provisions for water and sewer service based on the criteria previously described for sketch plans.

F. Site Development Plan (SDP)

The site development plan is a detailed design drawing required for all commercial, institutional, and industrial development and for the following types of residential lots:

1. Single family detached lots
2. Single family attached lots
3. Multi-family lots
4. Mobile home lots

In addition, all portions of the County zoned for "New Town" development require submission of a site development plan regardless of development type.

The site development plan may be submitted simultaneously with a final plat. The site development plan review and approval process is illustrated in **Figure 1-4**. The Department of Planning and Zoning distributes this plan for comment by the reviewing agencies. On the site development plan, existing and proposed building locations, structures, walkways, vegetative cover, existing and proposed grades, landscaping, and sediment and erosion control measures are identified. After plan approval, a building permit may be processed. Issuance of a building permit is contingent on execution of a Department of Public Works Developer Agreement where required.

1.16 Capacity Allocation Program

Howard County has developed and implemented a capacity allocation program to control connections to the public water and sewer systems in the Planned Service Area. Properties within the Metropolitan District are prioritized as to eligibility for connection in accordance with the requirements of Section 18.122B, "Allocation of Water and Sewer Capacity" of the Howard County Code.

Property in the Metropolitan District for which a subdivision has been recorded or which is undergoing the subdivision process is subject to the allocation program. Six (6) priority classifications have been established and each property is assigned one of these classifications. Capacity is reserved to satisfy the demands for priority no. 1 properties first, for priority no. 2 properties second, etc. until all available capacity is allocated. If insufficient capacity is available to satisfy all demands for priorities 1 through 6, then properties with lower assigned priorities cannot be given a capacity allocation. As a result, unless these properties are later assigned a higher priority in accordance with Section 18.122B, or additional capacity becomes available, connection to the public system cannot be made.

The assignment of priorities is a dynamic process. Priorities for properties undergoing subdivision are revised as certain steps in the subdivision process are reached. This process is further described in the following priority descriptions:

Priority No. 1, Buildings Under Construction - Buildings under construction which will be connected to the utility have the highest allocation priority.

For properties not requiring subdivision approval, a capacity allocation is assigned when a building permit is issued. If building footings are not installed within six months, or the building permit is revoked, the allocation is forfeited. A six-month extension of the footings installation deadline may be granted at the discretion of the Director of the Department of Inspections, Licenses, and Permits. If the allocation is forfeited, the property is assigned to priority category no. 5 until such time as a building permit may be reissued.

For a property located in an active subdivision for which a building permit has been issued, the allocation is a portion of that assigned to the subdivision at the time of execution of a Developer Agreement. This allocation is assigned for the term of the Developer Agreement and is forfeited when the Agreement expires. The term of the agreement may not exceed three years for commercial and single-family detached residential development. For all residential development except single-family detached, the term of the agreement may be up to four years. A request for a one-year extension of the Developer Agreement may be granted by the County at the discretion of the Director of the Department of Public Works. Portions of a subdivision remaining undeveloped upon expiration of the Agreement are assigned to priority category no. 5.

Priority No. 2, Buildings Required to Connect - Buildings in this category are existing structures which have been ordered to connect to public water or sewer by the County Health Department, Bureau of Environmental Health.

Priority No. 3, Buildable Lots in Active Subdivisions - Lots in subdivisions for which Developer Agreements have been executed and for which Building Permits have not been issued are assigned to this category. Once a building permit is issued for a property within an active subdivision, that property is assigned to priority category no. 1.

Priority No. 4, Properties Dependent upon Capital Project Completion - Developed properties presently utilizing private individual water supply or wastewater systems which can or must connect to the public system upon completion of a Capital Project are assigned to this category. The capital projects which will front these properties must be under construction, have grant funds approved, or be certified by the Director of the Department of Public Works as meeting County legislative requirements.

Priority No. 5, Other Buildable Lots - Legally buildable lots located within older inactive subdivisions and buildable lots in subdivisions for which Developer Agreements have expired are assigned to this category. On an annual basis the number of former inactive properties for which building permits will be requested is estimated. Capacity, when available, is assigned to this category to satisfy the anticipated demand. Once a building permit is issued, an allocation is assigned, and the property is moved to priority category no. 1. A building permit for a structure requiring connection to the public water or sewer system will not be issued if the property does not front an existing water or sewer line.

Priority No. 6, Proposed Subdivisions - This category contains all properties which have reached the final subdivision plat approval stage of the subdivision review process and require connection to the public water and sewer system. At this point, the subdivision is assigned a tentative water and/or sewer system allocation if capacity is available. Within 180 days from the date of approval of the final subdivision plat, the developer must enter into a Developer Agreement with the County to guarantee construction of required utilities. If this Agreement is not executed within 180 days, the tentative allocation is forfeited and the final plat approval is revoked. If the Agreement is executed, the subdivision allocation is assigned for the duration of the Agreement and the property is assigned to priority category no. 3.

The size of a capacity allocation assigned to a given property is determined based on the guidelines given in part (C)(7)(d) of Section 18.122B of the County Code.

CHAPTER 1

TABLES AND FIGURES

HOWARD COUNTY
WATER AND SEWER FACILITIES MANAGEMENT

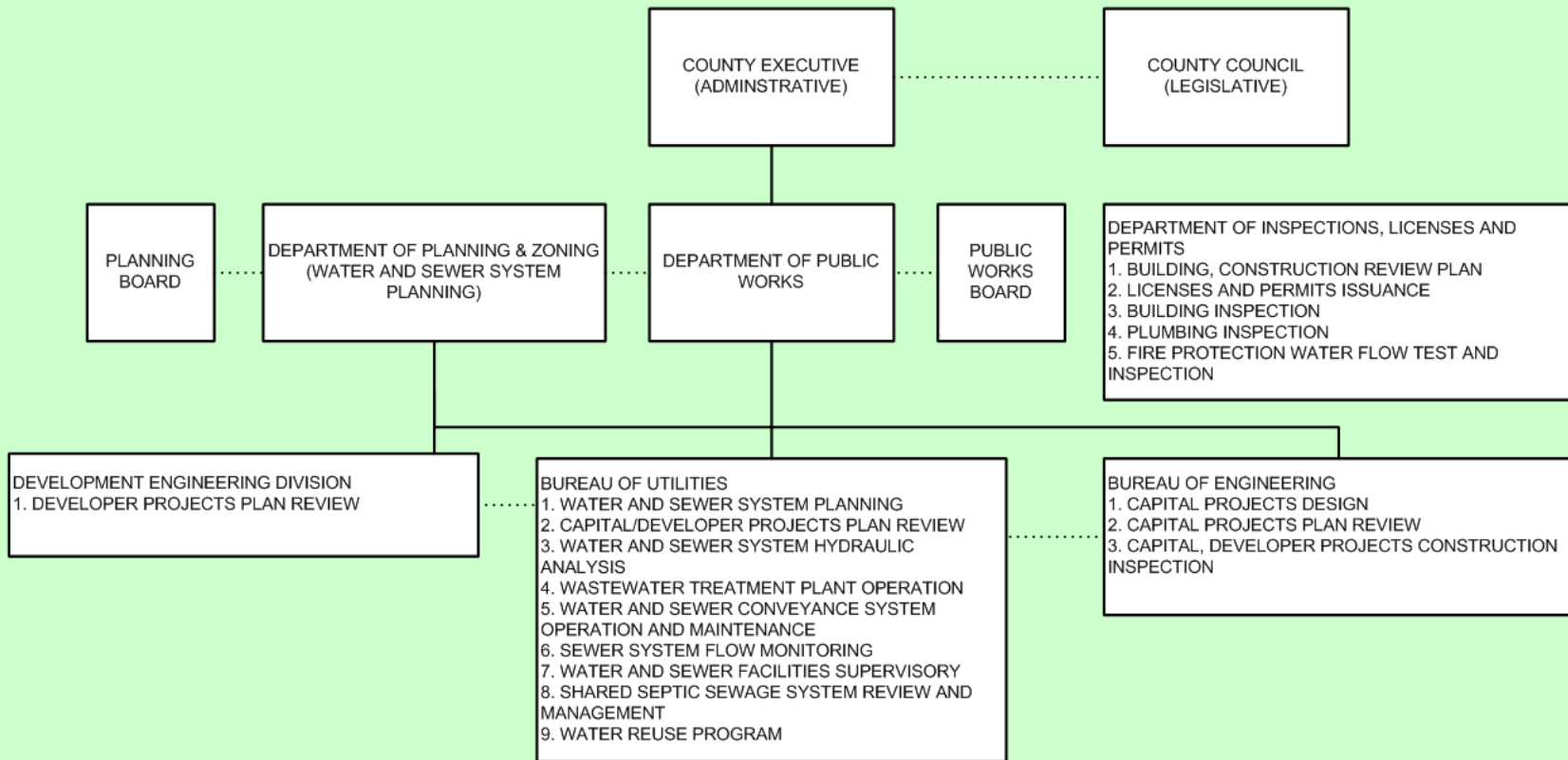

FIGURE 1-1

November 2015

WATER AND SEWER PLANNING AND GRANTS ADMINISTRATION

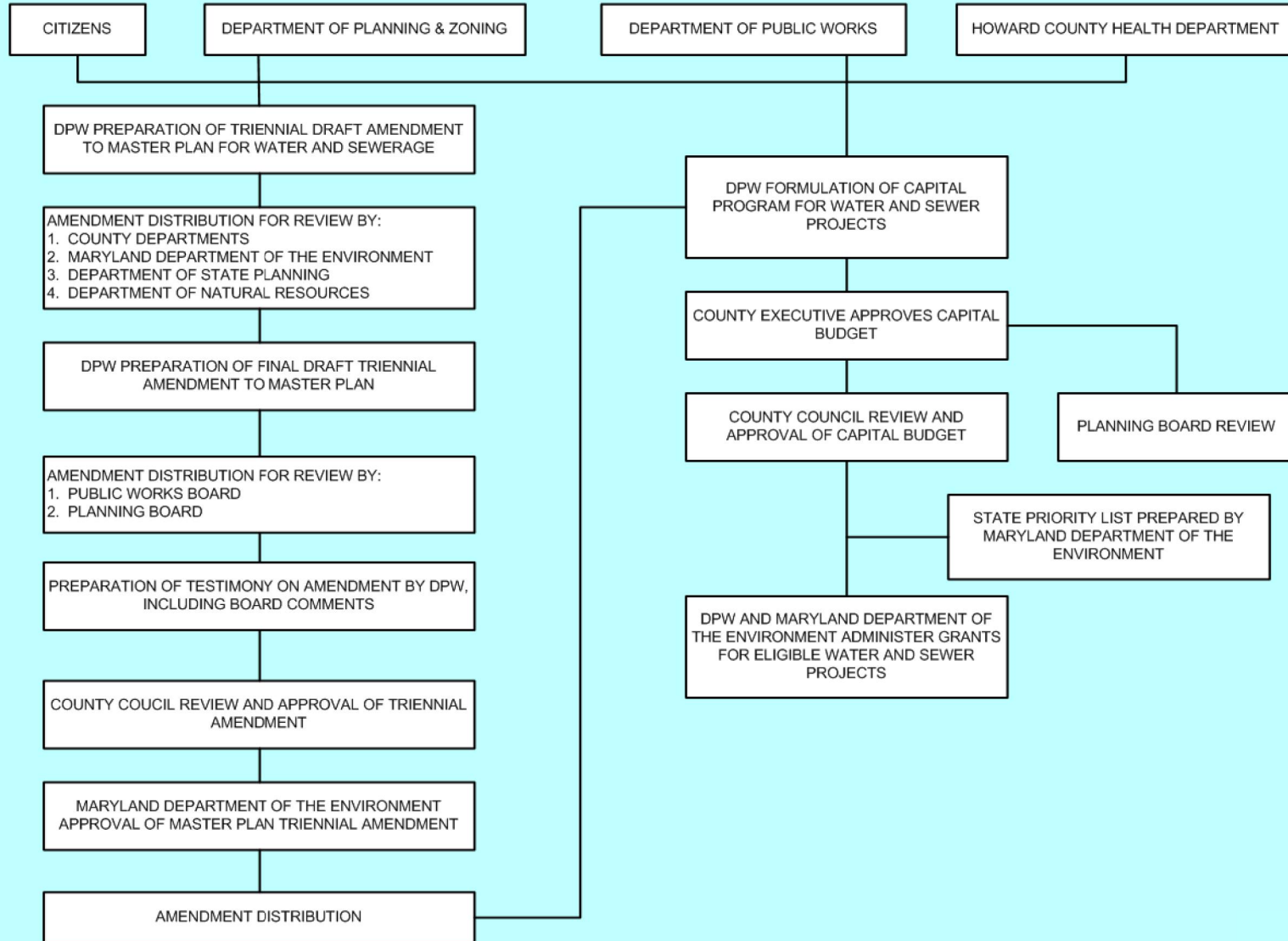
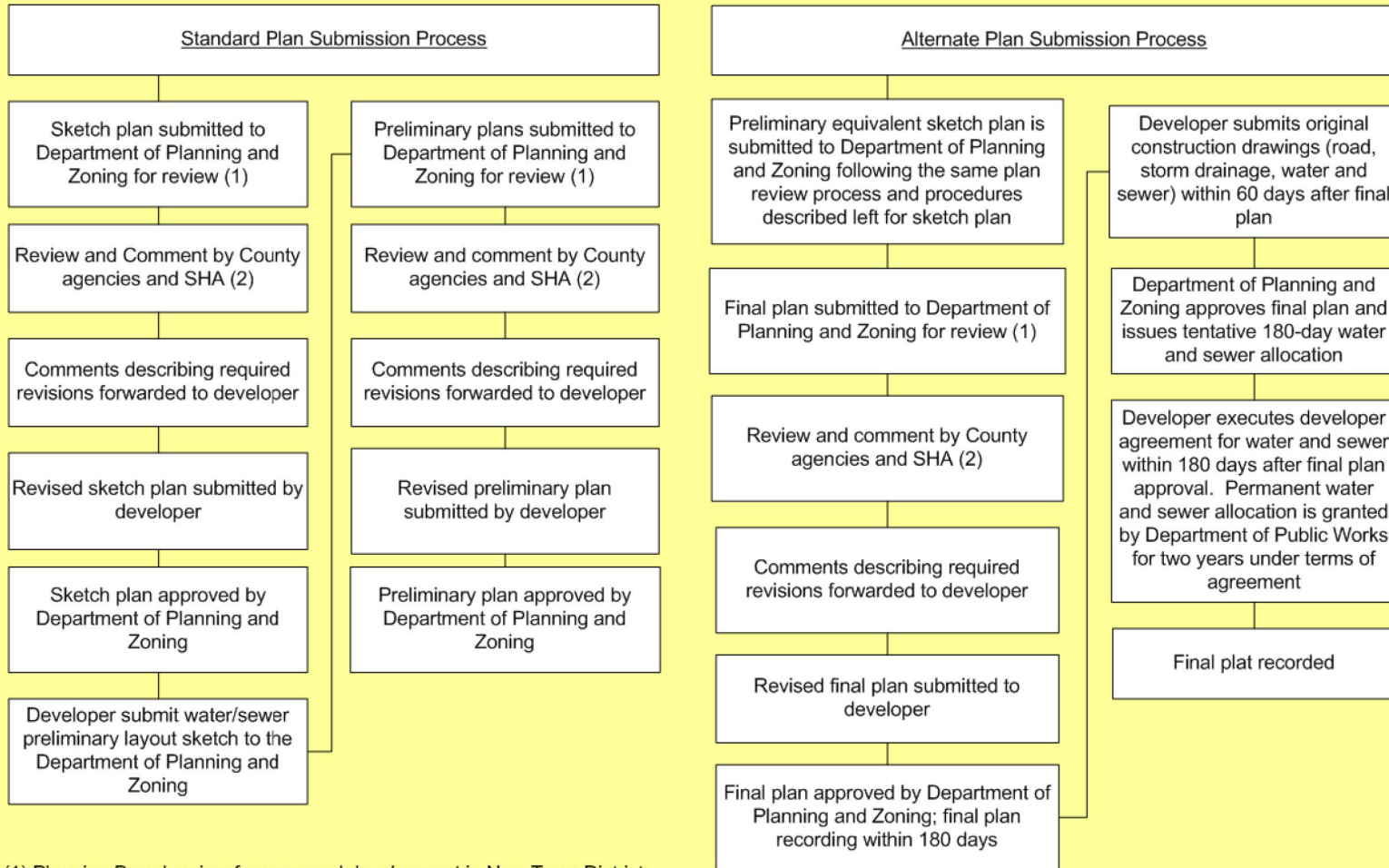

FIGURE 1-2

November 2015

SUBDIVISION PLAN REVIEW AND CAPACITY ALLOCATION PROCEDURE



(1) Planning Board review for proposed development in New Town District.

(2) County agencies include:

- | | |
|--|--|
| Department of Planning and Zoning | Department of Recreation and Parks |
| Department of Public Works | Department of Education |
| Soil Conservation District | Department of Inspections, Licenses, and Permits |
| Health Department | |
| Department of Fire and Rescue Services | |

FIGURE 1-3

November 2015

SITE DEVELOPMENT PLAN REVIEW PROCESS AND CAPACITY ALLOCATION PROCEDURE

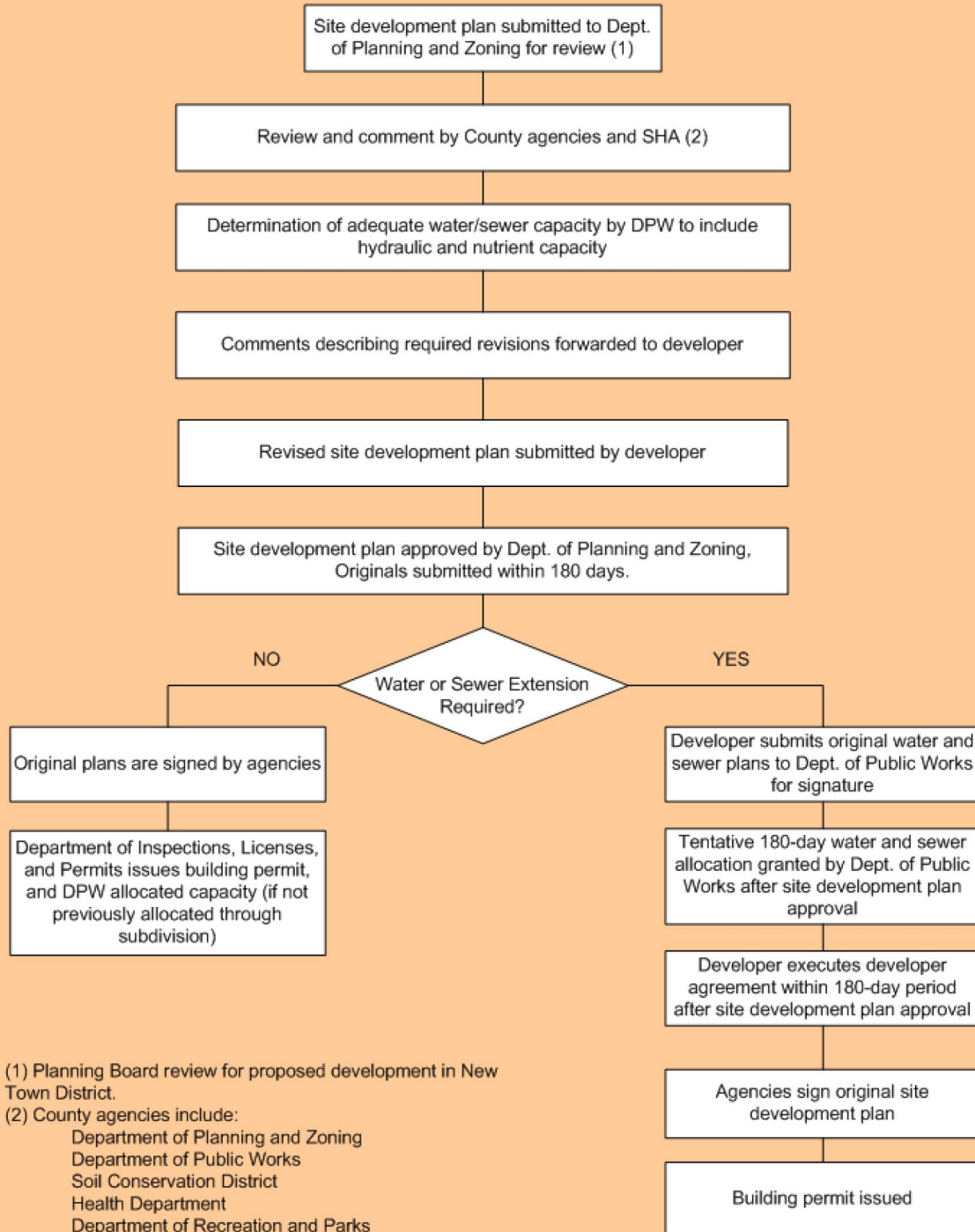

(1) Planning Board review for proposed development in New Town District.

(2) County agencies include:

- Department of Planning and Zoning
- Department of Public Works
- Soil Conservation District
- Health Department
- Department of Recreation and Parks
- Department of Education
- Department of Inspections, Licenses, and Permits
- Department of Fire and Rescue Services

FIGURE 1-4

CHAPTER 2

HOWARD COUNTY PROFILE AND GENERAL DATA

2.1 General

Howard County, an area of about 251 square miles, is situated in central Maryland. As shown in **Figure 2-1**, which is included at the end of this Chapter, it is bounded by Baltimore, Anne Arundel, Prince George's, Montgomery, Frederick and Carroll Counties. A mix of rural and suburban areas, Howard County lies between the two merging metropolitan areas of Baltimore and Washington, D.C. The County has realized a direct product of this merging of Baltimore and Washington in the town of Columbia and surrounding residential areas along Route 29 and in the industrial development along the I-95 and Route 1 corridors.

2.2 Natural Resources

Howard County lies primarily in the Piedmont Plateau with a small portion along the southeastern border in the Atlantic Coastal Plain physiographic region. The gently rolling terrain and soil characteristics throughout the middle and western parts of the County provide suitable areas for agricultural uses. Ground elevation varies from a low point of 20 feet in the east to as high as 875 feet in the west. A topographic map of Howard County is included in this Plan as **EXHIBIT 12**.

Howard County is classified into nine primary soil associations. **Figure 2-2**, which is included at the end of the Chapter, is a generalized soil map of the County that illustrates the location and extent of these soil associations. A soil association is an area with a distinctive pattern of soils with similar characteristics. It normally consists of one or more major soils and at least one minor soil, and is named for the major soils. The soils in one association may occur in another, but in a different pattern.

An evaluation of soil characteristics shows that about 85 percent of Howard County consists of well-drained and excessively-drained soils. About 10 percent of the County has somewhat poorly-drained soils and only 5 percent has poorly-drained soils. Approximately 65 percent of the soils are well suited for cultivation. Fifteen percent of the land can support occasional cultivation and 19 percent is unsuitable for cultivation but can be used for trees and some forage crops. Erosion is a potential problem when the

soils are cultivated. At least 87 percent of the land suitable for cultivation requires erosion control to lessen non-point source pollution.

The occurrence of groundwater in Howard County is largely dependent on the character, extent and structure of the rock formations. Most of the County is underlain by hard unweathered crystalline rock of low porosity. Therefore, the amount of water that can be stored underground is relatively low and groundwater yields are variable. During dry periods, the water table may drop and reduce the yields from wells and springs. Most groundwater derived from wells occurs predominantly under unconfined conditions in the shallow or more permeable part of the crystalline rocks. In general, the water quality of the groundwater withdrawn is acceptable for potable use. It is acidic, soft, and may contain significant levels of iron. **Figure 2-3** provides a generalized view of County geology. Further information on groundwater supplies is presented in Chapter 3, The Water Plan.

The major watersheds in Howard County are the Patapsco, Patuxent, Middle Patuxent, and Little Patuxent Rivers. **Figure 2-4** shows the major surface water patterns in the County. Data for the major watersheds is provided below:

USGS Gage Station ID	Stream	Drainage Area	Average Discharge	Maximum Discharge	Minimum Discharge
01589000	Patapsco	285 Sq. Miles	*	80,600 cfs	6.00 cfs
01591000	Patuxent	34.8 Sq. Miles	39.4 cfs	21,800 cfs	0.20 cfs
01592500	Patuxent	132 Sq. Miles	**	26,000 cfs	0.05 cfs
01593500	Little Patuxent	38 Sq. Miles	42.6 cfs	12,400 cfs	0.00 cfs
01591610	Patuxent	78.6 Sq. Miles	**	17,800 cfs	1.20 cfs
01591400	Patuxent/ Cattail Creek	22.9 Sq. Miles	24.9 cfs	4,000 cfs	1.80 cfs
Notes: * Flow is regulated by Liberty Reservoir ** Flow is regulated by Triadelphia and T. Howard Duckett Reservoirs					

Triadelphia Reservoir and T. Howard Duckett Reservoir on the Patuxent River have a combined storage volume of 12.5 billion gallons and are used as a source of water supply by the Washington Suburban Sanitary Commission. Smaller reservoirs for recreational purposes have been constructed in Columbia. The flow in the Patapsco River along the northern boundary of the County is regulated by Liberty Reservoir in Baltimore County and to a lesser degree by Piney Run Reservoir in Carroll County.

All surface waters in Howard County are classified by the Maryland Department of the Environment according to certain standards. This classification is based upon the Code of Maryland Regulations; COMAR 26.08.01, "Water Quality and Water Pollution Control." Standards are established for bacteriological (fecal coliform) populations, dissolved oxygen, temperature, pH and turbidity. These standards also include the prohibition of chlorine discharge to Class III Waters, "Natural Trout Waters." Waters within the County are classified as indicated in **Figure 2-5**.

2.3 Population

Howard County's total household population in 2014 was estimated at 306,606. The Howard County Department of Planning and Zoning has projected that in the year 2040 the total household population will be approximately 363,891. The population growth projected for Howard County is the result of two major factors - (1) its strategic location near the center of the expanding Baltimore-Washington region; and (2) that the major transportation corridor connecting the two metropolitan areas shifted from Anne Arundel County to Howard County via Interstate 95 and the dualization and interchange improvements of U.S. Route 29. **Figure 2-6** presents the population growth for Howard County from 1960 projected to 2040. **Table 1** presents household population projections by water zone for the planning period 2015 to 2040. **Table 1A** presents the non-residential acreage, by water zone, for the planning period. Similarly, **Tables 1B and 1C** present the household populations and non-residential acreages by sewer shed for the planning period. **Table 1D** presents Non-Residential Redevelopment numbers within Howard County.

Increasing urbanization is planned for the eastern portion of the County. Most of the population growth will be absorbed in Columbia and adjacent areas with residential development generally concentrating along the US Route 29, Route 40 and Route 1 corridors. **Figure 2-7, Figure 2-8 and Figure 2-9** show the existing and expected population densities by statistical area for the years 2015, 2025, and 2035 respectively.

2.4 Land Use

Howard County as it exists today is a diversified residential, agricultural, and industrial community. High and medium density residential development is centered in Columbia and in areas along U.S. Route 29, Route 40 and Route 1. Industrial development is located along the Interstate 95 and U.S. Route 1 corridor in the eastern portion of the County and in several planned industrial parks located in Columbia.

Agricultural and low-density rural residential areas of the County lie to the west of the planned water and sewerage service area. The existing land use pattern is given in **Figure 2-10**. Shown in **Figure 2-11** is the County's present zoning classification. **Table 2** summarizes the present zoning and existing land use of Howard County.

Figure 2-12 shows the existing and proposed major public institutions (such as schools, hospitals, correction facilities, and government complexes) in the County. **Table 2A** provides a summary of the approximate populations of these facilities.

The General Plan for Howard County, originally adopted in 2000 and updated in 2012 with the adoption of PlanHoward 2030, is a policy guide for general land use and development practices. One policy of the plan is to guide land development to those locations where the programmed capacity of public utilities and community facilities are designed to accommodate the expected levels of development. The PlanHoward 2030 “Designated Place Types Map” for Howard County is included as **EXHIBIT 13**.

CHAPTER 2

TABLES AND FIGURES

**TABLE 1
HOUSEHOLD POPULATION PROJECTIONS for PUBLIC WATER SERVICE**

2015 Totals

Water Service Area	Housing Category							Total
	SFD	SFA	APT	MH	AR- SFD	AR-SFA	AR-APT	
NPS	42,223	0	9	8	37	99	0	
350 Zone	574	72	62	0	0	0	0	
400 Zone	17,663	13,558	7,891	1,678	32	67	0	
550 II Zone (South)	57,207	28,605	19,345	1,749	32	810	1,643	
550 I Zone (North)	16,954	4,840	7,481	0	0	239	1,349	
630 East Zone	16,389	4,910	4,709		0	138	0	
630 South Zone	433	393	47	0	0	0	0	
630 West Zone	34,585	8,973	6,949	0	109	425	236	
730 Zone	1,735	1,074	337	0	153	303	481	
TOTAL IN PSA	145,540	62,425	46,821	3,427	326	1,982	3,709	264,230
TOTAL IN COUNTY	187,763	62,425	46,830	3,435	363	2,081	3,709	306,606

2020 Totals

Water Service Area	Housing Category							Total
	SFD	SFA	APT	MH	AR- SFD	AR-SFA	AR-APT	
NPS	43,490	0	9	8	37	99	0	
350 Zone	571	72	61	0	0	0	0	
400 Zone	18,474	15,336	14,375	1,661	32	67	0	
550 II Zone (South)	58,784	28,973	22,863	1,731	41	1,011	1,715	
550 I Zone (North)	17,303	5,222	7,975	0	53	252	1,715	
630 East Zone	16,321	5,078	4,661	0	0	138	0	
630 South Zone	1,363	616	47	0	0	0	0	
630 West Zone	36,012	9,930	7,861	0	109	688	612	
730 Zone	1,752	1,064	334	0	313	387	585	
TOTAL IN PSA	150,580	66,291	58,177	3,392	548	2,543	4,627	286,158
TOTAL IN COUNTY	194,070	66,291	58,186	3,400	585	2,642	4,627	329,801

2025 Totals

Water Service Area	Housing Category							Total
	SFD	SFA	APT	MH	AR- SFD	AR-SFA	AR-APT	
NPS	44,568	0	9	8	37	99	0	
350 Zone	593	71	61	0	0	0	0	
400 Zone	19,624	16,776	15,542	1,644	32	67	0	
550 II Zone (South)	60,893	29,593	25,941	1,716	41	1,011	1,814	
550 I Zone (North)	18,135	5,253	8,244	0	53	252	1,772	
630 East Zone	16,543	5,197	4,615	0	0	138	0	
630 South Zone	1,350	681	46	0	0	0	0	
630 West Zone	37,223	10,258	8,065	0	109	850	668	
730 Zone	1,789	1,053	330	0	313	387	585	
TOTAL IN PSA	156,150	68,882	62,844	3,360	548	2,705	4,839	299,328
TOTAL IN COUNTY	200,718	68,882	62,853	3,368	585	2,804	4,839	344,049

NPS= No Planned Public Water Service
SFD= Single Family Detached Unit
SFA= Single Family Attached Unit
APT= Apartment Unit (rental or condo)
MH= Mobile Home

AR-SFD= Age-Restricted Single Family Detached Unit
AR-SFA= Age-Restricted Single Family Attached Unit
AR-APT= Age-Restricted Apartment Unit (rental or condo)
PSA= Planned Public Water Service Area

**TABLE 1
HOUSEHOLD POPULATION PROJECTIONS for PUBLIC WATER SERVICE**

2030 Totals

Water Service Area	Housing Category							Total
	SFD	SFA	APT	MH	AR- SFD	AR-SFA	AR-APT	
NPS	46,065	0	9	8	37	99	0	
350 Zone	603	76	61	0	0	0	0	
400 Zone	20,328	17,415	17,542	1,644	32	67	0	
550 II Zone (South)	61,618	29,777	28,565	1,716	41	1,011	1,814	
550 I Zone (North)	18,649	5,417	8,332	0	53	252	1,772	
630 East Zone	16,687	5,205	5,062	0	0	138	0	
630 South Zone	1,350	681	46	0	0	0	0	
630 West Zone	37,958	10,281	8,083	0	109	850	668	
730 Zone	1,842	1,053	330	0	313	387	585	
TOTAL IN PSA	159,035	69,905	68,021	3,360	548	2,705	4,839	308,413
TOTAL IN COUNTY	205,100	69,905	68,030	3,368	585	2,804	4,839	354,631

2035 Totals

Water Service Area	Housing Category							Total
	SFD	SFA	APT	MH	AR- SFD	AR-SFA	AR-APT	
NPS	47,547	0	9	8	37	99	0	
350 Zone	603	76	61	0	0	0	0	
400 Zone	20,328	17,486	19,565	1,644	32	67	0	
550 II Zone (South)	61,883	29,827	30,894	1,716	41	1,011	1,814	
550 I Zone (North)	18,649	5,417	8,332	0	53	252	1,772	
630 East Zone	16,697	5,205	5,062	0	0	138	0	
630 South Zone	1,350	681	46	0	0	0	0	
630 West Zone	38,087	10,283	8,083	0	109	850	668	
730 Zone	1,885	1,053	330	0	313	387	585	
TOTAL IN PSA	159,482	70,028	72,373	3,360	548	2,705	4,839	313,335
TOTAL IN COUNTY	207,029	70,028	72,382	3,368	585	2,804	4,839	361,035

2040 Totals

Water Service Area	Housing Category							Total
	SFD	SFA	APT	MH	AR- SFD	AR-SFA	AR-APT	
NPS	49,035	0	9	8	37	99	0	
350 Zone	603	76	61	0	0	0	0	
400 Zone	20,328	17,486	19,855	1,644	32	67	0	
550 II Zone (South)	62,303	29,860	30,905	1,716	41	1,011	1,814	
550 I Zone (North)	18,649	5,417	8,332	0	53	252	1,772	
630 East Zone	16,715	5,205	5,062	0	0	138	0	
630 South Zone	1,350	681	46	0	0	0	0	
630 West Zone	38,555	10,362	8,083	0	109	850	668	
730 Zone	1,934	1,053	330	0	313	387	585	
TOTAL IN PSA	160,437	70,140	72,674	3,360	548	2,705	4,839	314,703
TOTAL IN COUNTY	209,472	70,140	72,683	3,368	585	2,804	4,839	363,891

NPS= No Planned Public Water Service
 SFD= Single Family Detached Unit
 SFA= Single Family Attached Unit
 APT= Apartment Unit (rental or condo)
 MH= Mobile Home

AR-SFD= Age-Restricted Single Family Detached Unit
 AR-SFA= Age-Restricted Single Family Attached Unit
 AR-APT= Age-Restricted Apartment Unit (rental or condo)
 PSA= Planned Public Water Service Area

**TABLE 1A
DEVELOPMENT of NON-RESIDENTIAL ACREAGE for PUBLIC WATER SERVICE**

2015 Totals

Water Service Area	Industrial Land	Commercial Land
No Planned Public Water Service	45.85	434.02
350 Zone	0.10	5.98
400 Zone	2,915.21	1,000.69
550-II Zone (South)	512.63	2,363.55
550-I Zone (North)	28.22	414.55
630 East Zone	53.56	220.42
630 South Zone	0.00	34.52
630 West Zone	20.73	337.88
730 Zone	4.23	47.73
TOTAL	3,580.53	4,859.34
Combined TOTAL	8,439.87	

2020 Totals

Water Service Area	Industrial Land	Commercial Land
No Planned Public Water Service	45.85	459.47
350 Zone	0.10	5.98
400 Zone	3,064.30	1,032.87
550-II Zone (South)	536.50	2,522.11
550-I Zone (North)	28.22	414.55
630 East Zone	61.76	221.34
630 South Zone	0.00	45.00
630 West Zone	20.73	404.89
730 Zone	4.23	47.73
TOTAL	3,761.69	5,153.94
Combined TOTAL	8,915.63	

2025 Totals

Water Service Area	Industrial Land	Commercial Land
No Planned Public Water Service	45.85	494.17
350 Zone	0.10	5.98
400 Zone	3,182.80	1,059.37
550-II Zone (South)	547.08	2,575.76
550-I Zone (North)	28.22	414.55
630 East Zone	61.76	247.18
630 South Zone	0.00	55.33
630 West Zone	20.73	419.10
730 Zone	4.23	47.73
TOTAL	3,890.77	5,319.17
Combined TOTAL	9,209.94	

**TABLE 1A
DEVELOPMENT of NON-RESIDENTIAL ACREAGE for PUBLIC WATER SERVICE**

2030 Totals

Water Service Area	Industrial Land	Commercial Land
No Planned Public Water Service	45.85	521.27
350 Zone	0.10	5.98
400 Zone	3,286.26	1,107.19
550-II Zone (South)	608.59	2,644.14
550-I Zone (North)	28.22	414.55
630 East Zone	61.76	266.96
630 South Zone	0.00	55.33
630 West Zone	20.73	419.10
730 Zone	14.23	47.73
TOTAL	4,065.74	5,482.25
Combined TOTAL	9,547.99	

2035 Totals

Water Service Area	Industrial Land	Commercial Land
No Planned Public Water Service	45.85	521.27
350 Zone	0.10	5.98
400 Zone	3,342.17	1,107.19
550-II Zone (South)	661.70	2,644.14
550-I Zone (North)	28.22	414.55
630 East Zone	61.76	266.96
630 South Zone	0.00	55.33
630 West Zone	20.73	419.10
730 Zone	24.20	47.73
TOTAL	4,184.73	5,482.25
Combined TOTAL	9,666.98	

2040 Totals

Water Service Area	Industrial Land	Commercial Land
No Planned Public Water Service	45.85	521.27
350 Zone	0.10	5.98
400 Zone	3,452.48	1,107.19
550-II Zone	661.70	2,644.14
550-I Zone	28.22	414.55
630 East Zone	61.76	266.96
630 South Zone	0.00	55.33
630 West Zone	20.73	419.10
730 Zone	48.40	95.46
TOTAL	4,319.24	5,529.98
Combined TOTAL	9,849.22	

**TABLE 1B
HOUSEHOLD POPULATION PROJECTIONS for PUBLIC SEWERAGE SERVICE**

2015 Totals

Sewer Drainage Area	SFD	SFA	APT	MH	AR- SFD	AR-SFA	AR-APT	Totals
NPS	42,223	0	9	8	37	99	0	42,376
AR	1,571	0	0	0	0	0	0	1,571
BB1	5,784	147	0	0	0	239	425	6,595
BB2	2,083	0	0	0	0	0	0	2,083
D	1,314	302	0	0	0	0	0	1,616
DP1	2,390	65	365	0	0	0	0	2,819
DP11	5,122	7,343	4,780	1,748	0	20	132	19,147
DP2	1,907	341	416	0	0	0	0	2,664
DP3	2,450	1,240	1,174	0	0	96	144	5,104
DP5	5,411	1,472	941	457	0	36	311	8,629
DP8	279	49	0	0	0	0	0	328
DR	3,356	3,105	1,785	870	0	418	225	9,759
EC	6,415	1,842	822	0	0	0	0	9,079
GR1	6	0	182	0	0	0	0	189
GR2	2,189	2,947	1,189	10	32	38	86	6,493
HB1	0	0	0	0	0	0	0	0
HB2	9,275	7,380	283	0	0	0	276	17,214
HB3	706	0	744	105	0	0	0	1,554
LP1	2,014	413	1,350	0	0	0	0	3,777
LP2	33,055	18,164	16,344	0	32	196	439	68,230
MP	18,011	5,685	5,840	0	0	44	29	29,608
NL1	4,746	4,939	1,681	235	0	29	0	11,630
PS1	29,275	5,262	3,254	0	262	675	906	39,632
RB	2,293	0	0	0	0	0	0	2,293
SB1	2,384	501	2,571	0	0	0	500	5,956
SB2	3,504	1,230	3,098	0	0	191	236	8,258
TOTAL IN PSA	143,968	62,426	46,820	3,426	326	1,982	3,709	262,658
TOTAL IN COUNTY	187,763	62,426	46,829	3,434	363	2,081	3,709	306,606

2020 Totals

Sewer Drainage Area	SFD	SFA	APT	MH	AR- SFD	AR-SFA	AR-APT	Totals
NPS	43,490	0	9	8	37	99	0	43,642
AR	1,590	0	0	0	0	0	0	1,590
BB1	5,956	187	244	0	0	239	425	7,050
BB2	2,087	0	0	0	0	0	0	2,087
D	1,391	299	0	0	0	0	0	1,690
DP1	2,546	504	2,338	0	0	0	0	5,388
DP11	5,124	8,224	7,377	1,731	0	84	179	22,719
DP2	1,963	506	497	0	0	0	0	2,965
DP3	2,515	1,261	1,163	0	0	96	144	5,179
DP5	5,645	1,460	932	453	0	36	311	8,837
DP8	286	471	0	0	0	0	0	756
DR	3,537	3,079	2,093	862	0	418	225	10,212
EC	6,397	1,936	814	0	0	13	30	9,190
GR1	6	0	751	0	0	0	0	757
GR2	2,382	2,918	1,177	10	32	38	86	6,644
HB1	0	0	0	0	0	0	0	0
HB2	10,338	7,569	291	0	0	0	276	18,474
HB3	733	0	737	103	0	0	0	1,573
LP1	2,022	460	1,336	0	0	0	0	3,818
LP2	32,724	17,982	19,398	0	32	196	439	70,772
MP	18,831	6,073	5,781	0	9	180	55	30,929
NL1	5,114	5,099	3,470	233	0	29	0	13,946
PS1	30,382	6,365	3,842	0	475	978	1,431	43,473
RB	2,540	8	0	0	0	0	0	2,548
SB1	2,404	673	2,546	0	0	0	500	6,121
SB2	4,068	1,217	3,392	0	0	236	526	9,439
TOTAL IN PSA	148,989	66,290	58,178	3,392	548	2,543	4,627	284,568
TOTAL IN COUNTY	194,069	66,290	58,187	3,400	585	2,642	4,627	329,800

SFD = Single Family Detached Unit NPS = No Planned Public Svc DR = Dorsey Run MP = Middle Patuxent
SFA = Single Family Attached Unit AR= Alpha Ridge EC = Ellicott City NL = North Laurel Pumping Station
APT = Apartment Unit (rental or condo) BB = Bonnie Branch GR = Guilford Run PS = Rt 108 Pumping Station
MH = Mobile Home D = Danials HB = Hammond Branch RB = Rockburn Pumping Station
AR-SFD= Age Restricted SFD DP = Deep Run LP = Little Patuxent SB = Sucker Branch

**TABLE 1B
HOUSEHOLD POPULATION PROJECTIONS for PUBLIC SEWERAGE SERVICE**

2025 Totals

Sewer Drainage Area	SFD	SFA	APT	MH	AR- SFD	AR-SFA	AR-APT	Totals
NPS	44,568	0	9	8	37	99	0	44,720
AR	1,599	0	0	0	0	0	0	1,599
BB1	6,505	241	273	0	0	239	425	7,683
BB2	2,100	0	0	0	0	0	0	2,100
D	1,592	296	0	0	0	0	0	1,889
DP1	2,589	499	2,422	0	0	0	0	5,509
DP11	5,214	8,420	7,518	1,716	0	84	278	23,231
DP2	2,066	916	804	0	0	0	0	3,787
DP3	2,690	1,286	1,165	0	0	96	144	5,381
DP5	5,909	1,544	994	448	0	36	311	9,243
DP8	443	559	156	0	0	0	0	1,158
DR	4,046	3,640	2,107	853	0	418	225	11,289
EC	6,607	1,947	806	0	0	13	30	9,403
GR1	6	0	744	0	0	0	0	750
GR2	2,546	2,909	1,198	10	32	38	86	6,819
HB1	0	0	0	0	0	0	0	0
HB2	10,797	8,129	590	0	0	0	276	19,792
HB3	726	13	844	102	0	0	0	1,684
LP1	2,041	504	1,323	0	0	0	0	3,868
LP2	32,437	17,802	21,978	0	32	196	439	72,885
MP	19,408	6,081	5,723	0	9	180	55	31,456
NL1	5,275	5,377	3,916	231	0	29	0	14,829
PS1	31,754	6,726	4,281	0	475	1,058	1,529	45,824
RB	3,056	94	0	0	0	0	0	3,150
SB1	2,567	694	2,520	0	0	0	500	6,281
SB2	4,178	1,205	3,480	0	0	317	541	9,722
TOTAL IN PSA	154,551	68,882	62,842	3,361	548	2,705	4,840	297,729
TOTAL IN COUNTY	200,718	68,882	62,851	3,368	585	2,804	4,840	344,048

2030 Totals

Sewer Drainage Area	SFD	SFA	APT	MH	AR- SFD	AR-SFA	AR-APT	Totals
NPS	46,065	0	9	8	37	99	0	46,218
AR	1,639	0	0	0	0	0	0	1,639
BB1	6,767	281	273	0	0	239	425	7,984
BB2	2,115	0	0	0	0	0	0	2,115
D	1,639	296	0	0	0	0	0	1,935
DP1	2,598	499	2,958	0	0	0	0	6,055
DP11	5,229	8,526	7,563	1,716	0	84	278	23,397
DP2	2,097	954	953	0	0	0	0	4,004
DP3	2,745	1,286	1,165	0	0	96	144	5,437
DP5	5,912	1,681	1,076	448	0	36	311	9,465
DP8	446	559	667	0	0	0	0	1,672
DR	4,596	4,091	2,107	853	0	418	225	12,290
EC	6,782	1,982	806	0	0	13	30	9,614
GR1	6	0	744	0	0	0	0	750
GR2	2,564	2,909	1,198	10	32	38	86	6,837
HB1	0	0	0	0	0	0	0	0
HB2	11,163	8,202	837	0	0	0	276	20,478
HB3	726	13	844	102	0	0	0	1,684
LP1	2,041	511	1,323	0	0	0	0	3,875
LP2	32,437	17,802	24,759	0	32	196	439	75,667
MP	19,608	6,081	5,723	0	9	180	55	31,656
NL1	5,337	5,380	4,638	231	0	29	0	15,615
PS1	32,563	6,840	4,299	0	475	1,058	1,529	46,764
RB	3,142	101	0	0	0	0	0	3,243
SB1	2,629	704	2,608	0	0	0	500	6,440
SB2	4,255	1,205	3,480	0	0	317	541	9,799
TOTAL IN PSA	157,395	69,905	68,020	3,361	548	2,705	4,840	306,774
TOTAL IN COUNTY	205,099	69,905	68,029	3,368	585	2,804	4,840	354,630

SFD = Single Family Detached Unit NPS = No Planned Public Svc DR = Dorsey Run MP = Middle Patuxent
SFA = Single Family Attached Unit AR= Alpha Ridge EC = Ellicott City NL = North Laurel Pumping Station
APT = Apartment Unit (rental or condo) BB = Bonnie Branch GR = Guilford Run PS = Rt 108 Pumping Station
MH = Mobile Home D = Danials HB = Hammond Branch RB = Rockburn Pumping Station
AR-SFD= Age Restricted SFD DP = Deep Run LP = Little Patuxent SB = Sucker Branch
AR-SFA= Age Restricted SFA
AR-APT= Age Restricted APT

**TABLE 1B
HOUSEHOLD POPULATION PROJECTIONS for PUBLIC SEWERAGE SERVICE**

2035 Totals

Sewer Drainage Area	SFD	SFA	APT	MH	AR- SFD	AR-SFA	AR-APT	Totals
NPS	47,547	0	9	8	37	99	0	47,699
AR	1,682	0	0	0	0	0	0	1,682
BB1	6,767	281	273	0	0	239	425	7,984
BB2	2,115	0	0	0	0	0	0	2,115
D	1,639	296	0	0	0	0	0	1,935
DP1	2,598	499	3,344	0	0	0	0	6,441
DP11	5,242	8,526	7,563	1,716	0	84	278	23,409
DP2	2,097	954	953	0	0	0	0	4,004
DP3	2,745	1,286	1,165	0	0	96	144	5,437
DP5	5,912	1,681	1,303	448	0	36	311	9,692
DP8	446	559	1,203	0	0	0	0	2,208
DR	4,605	4,091	2,107	853	0	418	225	12,299
EC	6,782	1,982	806	0	0	13	30	9,614
GR1	6	0	744	0	0	0	0	750
GR2	2,567	2,980	1,316	10	32	38	86	7,029
HB1	0	0	0	0	0	0	0	0
HB2	11,163	8,202	837	0	0	0	276	20,478
HB3	726	13	844	102	0	0	0	1,684
LP1	2,041	511	1,323	0	0	0	0	3,875
LP2	32,594	17,853	27,088	0	32	196	439	78,203
MP	19,817	6,083	5,723	0	9	180	55	31,868
NL1	5,337	5,380	5,394	231	0	29	0	16,371
PS1	32,575	6,840	4,299	0	475	1,058	1,529	46,776
RB	3,142	101	0	0	0	0	0	3,243
SB1	2,629	704	2,608	0	0	0	500	6,440
SB2	4,255	1,205	3,480	0	0	317	541	9,799
TOTAL IN PSA	157,797	70,029	72,373	3,361	548	2,705	4,840	311,653
TOTAL IN COUNTY	207,026	70,029	72,382	3,368	585	2,804	4,840	361,034

2040 Totals

Sewer Drainage Area	SFD	SFA	APT	MH	AR- SFD	AR-SFA	AR-APT	Totals
NPS	49,035	0	9	8	37	99	0	49,187
AR	1,731	0	0	0	0	0	0	1,731
BB1	6,767	281	273	0	0	239	425	7,984
BB2	2,115	0	0	0	0	0	0	2,115
D	1,639	296	0	0	0	0	0	1,935
DP1	2,598	499	3,344	0	0	0	0	6,441
DP11	5,248	8,526	7,563	1,716	0	84	278	23,415
DP2	2,097	954	953	0	0	0	0	4,004
DP3	2,745	1,286	1,165	0	0	96	144	5,437
DP5	5,912	1,681	1,303	448	0	36	311	9,692
DP8	446	559	1,276	0	0	0	0	2,281
DR	4,618	4,091	2,107	853	0	418	225	12,311
EC	6,782	1,982	806	0	0	13	30	9,614
GR1	6	0	744	0	0	0	0	750
GR2	2,570	2,980	1,316	10	32	38	86	7,032
HB1	0	0	0	0	0	0	0	0
HB2	11,163	8,202	837	0	0	0	276	20,478
HB3	726	13	844	102	0	0	0	1,684
LP1	2,041	511	1,323	0	0	0	0	3,875
LP2	32,861	17,883	27,099	0	32	196	439	78,512
MP	20,435	6,164	5,723	0	9	180	55	32,567
NL1	5,337	5,380	5,611	231	0	29	0	16,587
PS1	32,575	6,840	4,299	0	475	1,058	1,529	46,776
RB	3,142	101	0	0	0	0	0	3,243
SB1	2,629	704	2,608	0	0	0	500	6,440
SB2	4,255	1,205	3,480	0	0	317	541	9,799
TOTAL IN PSA	158,704	70,141	72,673	3,361	548	2,705	4,840	312,972
TOTAL IN COUNTY	209,470	70,141	72,682	3,368	585	2,804	4,840	363,890

SFD = Single Family Detached Unit NPS= No Planned Public Svc DR = Dorsey Run MP = Middle Patuxent
 SFA = Single Family Attached Unit AR= Alpha Ridge EC = Ellicott City NL = North Laurel Pumping Station
 APT = Apartment Unit (rental or condo) BB = Bonnie Branch GR = Guilford Run PS = Rt 108 Pumping Station
 MH = Mobile Home D = Danials HB = Hammond Branch RB = Rockburn Pumping Station
 AR-SFD= Age Restricted SFD DP = Deep Run LP = Little Patuxent SB = Sucker Branch

**TABLE 1C
DEVELOPMENT of NON RESIDENTIAL ACREAGE for PUBLIC SEWERAGE SERVICE**

2015 Totals

Sewer Drainage Area	Industrial Land	Commercial Land	Combined
NPS	434.02	45.85	479.87
AR	0.00	0.00	0.00
BB1	9.80	0.00	9.80
BB2	0.00	0.00	0.00
D	0.57	13.97	14.54
DP1	187.12	221.02	408.14
DP11	100.02	28.45	128.47
DP2	51.66	21.47	73.13
DP3	49.93	213.12	263.05
DP5	131.82	392.06	523.88
DP8	84.25	290.65	374.90
DR	491.70	949.51	1,441.21
EC	128.83	21.66	150.49
GR1	64.86	423.87	488.73
GR2	416.52	299.49	716.01
HB1	4.80	68.66	73.46
HB2	207.94	55.92	263.86
HB3	20.03	72.50	92.53
LP1	64.35	108.82	173.17
LP2	1,129.18	284.79	1,413.97
MP	660.03	5.60	665.63
NL1	107.57	36.01	143.58
PS1	366.41	21.79	388.20
RB	0.00	0.00	0.00
SB1	16.99	5.32	22.31
SB2	130.94	0.00	130.94
Subtotal PSA	4,425.32	3,534.68	7,960.00
Total County	4,859.34	3,580.53	8,439.87

2020 Totals

Sewer Drainage Area	Industrial Land	Commercial Land	Combined
NPS	459.47	45.85	505.32
AR	0.00	0.00	0.00
BB1	9.80	0.00	9.80
BB2	0.00	0.00	0.00
D	0.57	13.97	14.54
DP1	187.12	257.54	444.66
DP11	102.75	28.45	131.20
DP2	52.42	21.69	74.11
DP3	52.12	218.94	271.06
DP5	151.12	408.18	559.30
DP8	84.25	338.52	422.77
DR	500.52	986.60	1,487.12
EC	128.83	21.66	150.49
GR1	65.62	430.46	496.08
GR2	433.97	302.34	736.31
HB1	6.78	68.66	75.44
HB2	296.45	57.81	354.26
HB3	20.35	72.50	92.85
LP1	66.76	108.82	175.58
LP2	1,144.12	305.51	1,449.63
MP	706.31	5.60	711.91
NL1	119.14	36.25	155.39
PS1	403.72	27.74	431.46
RB	0.00	0.00	0.00
SB1	19.31	5.32	24.63
SB2	147.14	0.00	147.14
Subtotal PSA	4,699.17	3,716.56	8,415.73
Total County	5,158.64	3,762.41	8,921.05

Ind = Industrial Land
Com - Commercial Land

NPS = No Planned Public Sewer
AR= Alpha Ridge (NPS)
BB = Bonnie Branch
D = Daniels
DP = Deep Run
DR = Dorsey Run
EC = Ellicott City
GR = Guilford Run

HB = Hammond Branch
LP = Little Patuxent
MP = Middle Patuxent
NL = North Laurel Pump Station
PS = Rt 108 Pump Station
RB = Rockburn Pump Station
SB = Sucker Branch

**TABLE 1C
DEVELOPMENT of NON RESIDENTIAL ACREAGE for PUBLIC SEWERAGE SERVICE**

2025 Totals

Sewer Drainage Area	Industrial Land	Commercial Land	Combined
NPS	494.17	45.85	540.02
AR	0.00	0.00	0.00
BB1	9.80	0.00	9.80
BB2	0.00	0.00	0.00
D	0.57	13.97	14.54
DP1	187.12	277.06	464.18
DP11	128.91	28.45	157.36
DP2	53.98	21.69	75.67
DP3	56.88	232.12	289.00
DP5	154.32	418.01	572.33
DP8	84.25	361.15	445.40
DR	509.92	1,032.23	1,542.15
EC	128.83	21.66	150.49
GR1	65.62	444.05	509.67
GR2	442.79	302.34	745.13
HB1	6.78	68.66	75.44
HB2	319.50	57.81	377.31
HB3	21.84	72.50	94.34
LP1	66.76	109.02	175.78
LP2	1,144.12	307.58	1,451.70
MP	716.31	8.03	724.34
NL1	127.02	36.25	163.27
PS1	437.93	27.74	465.67
RB	0.00	0.00	0.00
SB1	19.31	5.32	24.63
SB2	147.14	0.00	147.14
Subtotal PSA	4,829.70	3,845.64	8,675.34
Total County	5,323.87	3,891.49	9,215.36

2030 Totals

Sewer Drainage Area	Industrial Land	Commercial Land	Combined
NPS	521.27	45.85	567.12
AR	0.00	0.00	0.00
BB1	9.80	0.00	9.80
BB2	0.00	0.00	0.00
D	0.57	13.97	14.54
DP1	187.12	315.96	503.08
DP11	131.15	36.63	167.78
DP2	53.98	21.69	75.67
DP3	56.88	243.12	300.00
DP5	154.32	421.26	575.58
DP8	84.25	364.91	449.16
DR	512.27	1,053.36	1,565.63
EC	128.83	21.66	150.49
GR1	65.62	446.00	511.62
GR2	442.79	317.34	760.13
HB1	11.46	74.18	85.64
HB2	340.84	89.41	430.25
HB3	25.68	73.95	99.63
LP1	67.92	109.02	176.94
LP2	1,144.12	307.58	1,451.70
MP	761.11	13.36	774.47
NL1	162.81	54.15	216.96
PS1	457.71	37.74	495.45
RB	0.00	0.00	0.00
SB1	19.31	5.32	24.63
SB2	147.14	0.00	147.14
Subtotal PSA	4,965.68	4,020.61	8,986.29
Total County	5,486.95	4,066.46	9,553.41

Ind = Industrial Land
Com - Commercial Land

NPS = No Planned Public Sewer
AR= Alpha Ridge (NPS)
BB = Bonnie Branch
D = Daniels
DP = Deep Run
DR = Dorsey Run
EC = Ellicott City
GR = Guilford Run

HB = Hammond Branch
LP = Little Patuxent
MP = Middle Patuxent
NL = North Laurel Pump Station
PS = Rt 108 Pump Station
RB = Rockburn Pump Station
SB = Sucker Branch

**TABLE 1C
DEVELOPMENT of NON RESIDENTIAL ACREAGE for PUBLIC SEWERAGE SERVICE**

2035 Totals

Sewer Drainage Area	Industrial Land	Commercial Land	Combined
NPS	521.27	45.85	567.12
AR	0.00	0.00	0.00
BB1	9.80	0.00	9.80
BB2	0.00	0.00	0.00
D	0.57	13.97	14.54
DP1	187.12	336.59	523.71
DP11	131.15	36.63	167.78
DP2	53.98	21.69	75.67
DP3	56.88	243.12	300.00
DP5	154.32	421.26	575.58
DP8	84.25	374.91	459.16
DR	512.27	1,070.70	1,582.97
EC	128.83	21.66	150.49
GR1	65.62	446.00	511.62
GR2	442.79	351.98	794.77
HB1	11.46	74.18	85.64
HB2	340.84	115.82	456.66
HB3	25.68	73.95	99.63
LP1	67.92	109.02	176.94
LP2	1,144.12	307.58	1,451.70
MP	761.11	13.36	774.47
NL1	162.81	54.15	216.96
PS1	457.71	47.71	505.42
RB	0.00	0.00	0.00
SB1	19.31	5.32	24.63
SB2	147.14	0.00	147.14
Subtotal PSA	4,965.68	4,139.60	9,105.28
Total County	5,486.95	4,185.45	9,672.40

2040 Totals

Sewer Drainage Area	Industrial Land	Commercial Land	Combined
NPS	521.27	45.85	567.12
AR	0.00	0.00	0.00
BB1	9.80	0.00	9.80
BB2	0.00	0.00	0.00
D	0.57	13.97	14.54
DP1	187.12	373.99	561.11
DP11	131.15	36.63	167.78
DP2	53.98	21.69	75.67
DP3	56.88	243.12	300.00
DP5	154.32	421.26	575.58
DP8	84.25	403.99	488.24
DR	512.27	1,114.53	1,626.80
EC	128.83	21.66	150.49
GR1	65.62	446.00	511.62
GR2	442.79	351.98	794.77
HB1	11.46	74.18	85.64
HB2	340.84	115.82	456.66
HB3	25.68	73.95	99.63
LP1	67.92	109.02	176.94
LP2	1,144.12	307.58	1,451.70
MP	761.11	13.36	774.47
NL1	162.81	54.15	216.96
PS1	457.71	47.71	505.42
RB	0.00	0.00	0.00
SB1	19.31	5.32	24.63
SB2	147.14	0.00	147.14
Subtotal PSA	4,965.68	4,249.91	9,215.59
Total County	5,486.95	4,295.76	9,782.71

Ind = Industrial Land
Com = Commercial Land

NPS = No Planned Public Sewer
AR= Alpha Ridge (NPS)
BB = Bonnie Branch
D = Daniels
DP = Deep Run
DR = Dorsey Run
EC = Ellicott City
GR = Guilford Run

HB = Hammond Branch
LP = Little Patuxent
MP = Middle Patuxent
NL = North Laurel Pump Station
PS = Rt 108 Pump Station
RB = Rockburn Pump Station
SB = Sucker Branch

TABLE 1D
REDEVELOPMENT CUMULATIVE DATA

Year	Retail Space (gsf)	Office Space (gsf)
2015	39,640	333,318
2020	218,264	961,528
2025	534,622	2,736,706
2030	841,567	3,690,876
2035	1,260,846	5,346,886
2040	1,638,010	7,061,418
TOTAL	4,532,949	20,130,732
Combined TOTAL	24,663,681	

gsf= gross square feet

TABLE 2

LAND USE IN HOWARD COUNTY

LAND USE (September 30, 2014)		
Land Use	Acres	Percentage of Total
Developed Residential	56,052	34.9%
Commercial, Industrial, Government, Transportation, Communication, and Utilities	25,344	15.8%
Parks and Open Space	29,009	18.1%
Preservation Easements/Historic Districts	31,543	19.6%
Undeveloped Land (Including non-preserved Ag Land)	18,692	11.6%
TOTAL County Acres	160,640	100.0%

EXISTING ZONING		
Land Use (Undeveloped Land)	Acres	Percentage of Total
RESIDENTIAL	16,995	90.9%
COMMERCIAL	706	3.8%
INDUSTRIAL	770	4.1%
GOVERNMENT AND INSTITUTIONAL	222	1.2%
TOTAL	18,692	100.0%

TABLE 2A

Estimated Enrollments/Population of Schools and Institutions in Howard County - 2014 (1)

Institution	Address Number	Street Name	Street Type	City	Zip	Enrollments/ Population	Map Location ID (2)	Type
Atholton	6700	Seneca	DR	Columbia	21046	367	1	Elem School
Bellows Spring	8125	Old Stockbridge	RD	Ellicott City	21043	677	2	Elem School
Bollman Bridge	8200	Savage Guilford	RD	Jessup	20794	665	3	Elem School
Bryant Woods	5450	Blue Heron	LN	Columbia	21044	332	4	Elem School
Bushy Park	14601	Carrs Mill	RD	Woodbine	21797	607	5	Elem School
Centennial Lane	3825	Centennial	LN	Ellicott City	21042	684	6	Elem School
Clarksville	12041	Clarksville	PK	Clarksville	21029	485	7	Elem School
Clemens Crossing	10320	Quarterstaff	RD	Columbia	21044	489	8	Elem School
Cradlerock	6700	Cradlerock	WAY	Columbia	21045	426	9	Elem School
Dayton Oaks	4691	Ten Oaks	RD	Dayton	21036	601	10	Elem School
Deep Run	6925	Old Waterloo	RD	Elkridge	21075	653	11	Elem School
Ducketts Lane	6501	Ducketts	LN	Elkridge	21075	699	12	Elem School
Elkridge	7075	Montgomery	RD	Elkridge	21075	790	13	Elem School
Forest Ridge	9550	Gorman	RD	Laurel	20723	722	14	Elem School
Fulton	11600	Scaggsville	RD	Fulton	20759	705	15	Elem School
Gorman Crossing	9999	Winter Sun	RD	Laurel	20723	625	16	Elem School
Guilford	7335	Oakland Mills	RD	Columbia	21046	480	17	Elem School
Hammond	8110	Aladdin	DR	Laurel	20723	636	18	Elem School
Hollifield Station	8701	Stonehouse	DR	Ellicott City	21043	696	19	Elem School
Ilchester	4981	Ilchester	RD	Ellicott City	21043	721	20	Elem School
Jeffers Hill	6000	Tamar	DR	Columbia	21045	464	21	Elem School
Laurel Woods	9250	North Laurel	RD	Laurel	20723	562	22	Elem School
Lisbon	15901	Frederick	RD	Woodbine	21797	422	23	Elem School
Longfellow	5470	Hesperus	DR	Columbia	21044	420	24	Elem School
Manor Woods	11575	Frederick	RD	Ellicott City	21042	672	25	Elem School
Northfield	9125	Northfield	RD	Ellicott City	21042	691	26	Elem School
Phelps Luck	5370	Oldstone	CT	Columbia	21045	541	27	Elem School
Pointers Run	6600	South Trotter	RD	Clarksville	21029	746	28	Elem School
Rockburn	6145	Montgomery	RD	Elkridge	21075	608	29	Elem School
Running Brook	5215	West Running Brook	RD	Columbia	21044	488	30	Elem School
St. Johns Lane	2960	Saint Johns	LN	Ellicott City	21042	722	31	Elem School
Stevens Forest	6045	Stevens Forest	RD	Columbia	21045	396	32	Elem School
Swansfield	5610	Cedar	LN	Columbia	21044	546	33	Elem School
Talbott Springs	9550	Basket Ring	RD	Columbia	21045	427	34	Elem School
Thunder Hill	9357	Mellenbrook	RD	Columbia	21045	528	35	Elem School
Triadelphia Ridge	13400	Triadelphia	RD	Ellicott City	21042	509	36	Elem School
Veterans	4355	Montgomery	RD	Ellicott City	21043	811	37	Elem School
Waterloo	5940	Waterloo	RD	Columbia	21045	559	38	Elem School

TABLE 2A

Estimated Enrollments/Population of Schools and Institutions in Howard County - 2014 (1)

Institution	Address Number	Street Name	Street Type	City	Zip	Enrollments/ Population	Map Location ID (2)	Type
Waverly	10220	Wetherburn	RD	Ellicott City	21042	706	39	Elem School
West Friendship	12500	Frederick	RD	West Friendship	21794	287	40	Elem School
Worthington	4570	Roundhill	RD	Ellicott City	21043	552	41	Elem School
Bonnie Branch	4979	Ilchester	RD	Ellicott City	21043	643	42	Middle School
Burleigh Manor	4200	Centennial	LN	Ellicott City	21042	744	43	Middle School
Clarksville	6535	South Trotter	RD	Clarksville	21029	635	44	Middle School
Dunloggin	9129	Northfield	RD	Ellicott City	21042	608	45	Middle School
Elkridge Landing	7085	Montgomery	RD	Elkridge	21075	714	46	Middle School
Ellicott Mills	4445	Montgomery	RD	Ellicott City	21043	762	47	Middle School
Folly Quarter	13500	Triadelphia	RD	Ellicott City	21042	562	48	Middle School
Glenwood	2680	Rt 97		Glenwood	21738	555	49	Middle School
Hammond	8110	Aladdin	DR	Laurel	20723	552	50	Middle School
Harpers Choice	5450	Beaverkill	RD	Columbia	21044	523	51	Middle School
Lake Elkhorn	6700	Cradlerock	WAY	Columbia	21045	501	52	Middle School
Lime Kiln	11650	Scaggsville	RD	Fulton	20759	703	53	Middle School
Mayfield Woods	7950	Red Barn	WAY	Elkridge	21075	635	54	Middle School
Mount View	12101	Woodford	DR	Marriottsville	21104	750	55	Middle School
Murray Hill	9989	Winter Sun	RD	Laurel	20723	595	56	Middle School
Oakland Mills	9540	Kilimanjaro	RD	Columbia	21045	423	57	Middle School
Patapsco	8885	Old Frederick	RD	Ellicott City	21043	676	58	Middle School
Patuxent Valley	9151	Vollmerhausen	RD	Jessup	20794	653	59	Middle School
Thomas Viaduct	7000	Banbury	DR	Hanover	21076	525	60	Middle School
Wilde Lake	10481	Cross Fox	LN	Columbia	21044	523	61	Middle School
Atholton	6520	Freetown	RD	Columbia	21044	1,468	62	High School
Centennial	4300	Centennial	LN	Ellicott City	21042	1,409	63	High School
Glenelg	14025	Burntwoods	RD	Glenelg	21737	1,265	64	High School
Hammond	8800	Guilford	RD	Columbia	21046	1,244	65	High School
Howard	8700	Old Annapolis	RD	Ellicott City	21043	1,764	66	High School
Long Reach	6101	Old Dobbin	LN	Columbia	21045	1,466	67	High School
Marriotts Ridge	12100	Woodford	DR	Marriottsville	21104	1,167	68	High School
Mt. Hebron	9440	Old Frederick	RD	Ellicott City	21042	1,504	69	High School
Oakland Mills	9410	Kilimanjaro	RD	Columbia	21045	1,109	70	High School
Reservoir	11550	Scaggsville	RD	Fulton	20759	1,495	71	High School
River Hill	12101	Clarksville	PK	Clarksville	21029	1,312	72	High School
Wilde Lake	5460	Trumpeter	RD	Columbia	21044	1,263	73	High School
Applications & Research Lab	10920	State Route 108		Ellicott City	21042	558	74	Special School
Cedar Lane	11630	Scaggsville	RD	Fulton	20759	130	75	Special School

TABLE 2A

Estimated Enrollments/Population of Schools and Institutions in Howard County - 2014 (1)

Institution	Address Number	Street Name	Street Type	City	Zip	Enrollments/ Population	Map Location ID (2)	Type
Homewood	10914	State Route 108		Ellicott City	21042	145	76	Special School
Howard Community College	10901	Little Patuxent	Pkwy	Columbia	21044	9,500	77	College
JHU Engineering for Professionals	6810	Deerpath	Rd	Columbia	21044	2,974	78	College
Loyola University	8890	McGaw	Rd	Columbia	21045	345	79	College
Maryland University of Integrative Health	7750	Montpelier	Rd	Laurel	20723	500	80	College
University College	6865	Deerpath	Rd	Elkridge	21075	100	81	College
University of Phoenix	8830	Stanford	Blvd	Columbia	21045	1,000	82	College
Brighton Gardens	7110	Minstrel	Way	Columbia	21045	98	83	Group
Clifton T Perkins	8450	Dorsey Run	Rd	Jessup	20794	236	84	Group
Ellicott City Health & Rehab	3000	North Ridge	Rd	Ellicott City	21043	182	85	Group
Encore - Turf Valley	11150	Resort	Rd	Ellicott City	21042	157	86	Group
Harmony Hall	6336	Cedar	Ln	Columbia	21044	235	87	Group
Heartlands	3004	North Ridge	Rd	Ellicott City	21043	250	88	Group
Howard County Detention Center	7301	Waterloo	Rd	Jessup	20794	250	89	Group
Howard County General Hospital	5755	Cedar	Ln	Columbia	21044	180	90	Group
Lighthouse Senior Living	3100	North Ridge	Rd	Ellicott City	21043	34	91	Group
Lorien Elkridge	7615	Washington	Blvd	Elkridge	21075	64	92	Group
Lorien Nursing Home	6334	Cedar	Ln	Columbia	21044	209	93	Group
Morningside House	5330	Dorsey Hall	Dr	Ellicott City	21042	119	94	Group
Patuxent Institute	7555	Waterloo	Road	Jessup	20794	954	95	Group
Shangrila	4475	Montgomery	Rd	Ellicott City	21043	60	96	Group
Shepherd Pratt	4100	College	Ave	Ellicott City	21043	45	97	Group
Somerford Place	8220	Snowden River	Pkwy	Columbia	21045	64	98	Group
Sunrise Assisted Living at Hickory Ridge	6500	Freetown	Rd	Columbia	21044	96	99	Group
Vantage House Life Care Facility	5400	Vantage Point	Rd	Columbia	21044	260	100	Group
Atholton Adventist School	6520	Martin	Rd	Columbia	21044	178	101	Other
Bet Yeladim, Inc.	8910	State Route 108		Columbia	21045	160	102	Other
Bethel Christian Academy 5-8	9001	Vollmerhausen	Rd	Jessup	20794	95	103	Other
Bethel Christian Academy K-4	8455	Savage-Guilford	Rd	Savage	20763	215	104	Other
Bright Stars Learning Academy	5890	Cedar	Lane	Columbia	21044	66	105	Other
Brookfield Christian School	6347	Ten Oaks	Rd	Clarksville	21029	165	106	Other
Bryant Woods Montessori	10449	Green Mountain	Cir	Columbia	21044	35	107	Other
Celebration Christian Academy	6080	Foreland	Garth	Columbia	21045	57	108	Other
Chapelgate Christian Academy	2600	Marriottsville	Rd	Marriottsville	21104	374	109	Other
Children's Manor Montessori School	4465	Montgomery	Rd	Ellicott City	21043	134	110	Other
Children's Manor School	9008	Red Branch	Rd	Columbia	21045	13	111	Other
Children's World Learning Center (Kinder Care)	7195	Columbia Gateway	Dr	Columbia	21046	70	112	Other

TABLE 2A

Estimated Enrollments/Population of Schools and Institutions in Howard County - 2014 (1)

Institution	Address Number	Street Name	Street Type	City	Zip	Enrollments/ Population	Map Location ID (2)	Type
Columbia Academy	10350	Old Columbia	Rd	Columbia	21046	250	113	Other
Columbia Montessori School	10508	Marble Faun	Ct	Columbia	21044	76	114	Other
Crossroads Adventist School	3291	Saint Johns	Lane	Ellicott City	21042	48	115	Other
Glenelg Country School	12793	Folly Quarter		Ellicott City	21042	800	116	Other
Goddard School	9100	Quarterstaff	Pkwy	Columbia	21045	120	117	Other
High School Road Academy	9705	Washington	Blvd	Laurel	20723	77	118	Other
Julia Brown Montessori School	9450	Madison	Ave	Laurel	20723	60	119	Other
Julia Brown Montessori School	9760	Owen Brown	Rd	Columbia	21045	100	120	Other
Kinder Ridge	8251	Tamar	Dr	Columbia	21046	152	121	Other
KinderCare Learning Center	7195	Columbia Gateway	Dr	Columbia	21046	80	122	Other
Lincoln Tech	9325	Snowden River	Pkwy	Columbia	21046	839	123	Other
Linwood Children's Center	3421	Martha Bush	Dr	Columbia	21043	89	124	Other
Lornwood	10453	Green Mountain	Cir	Columbia	21044	68	125	Other
Love of Learning Montessori School	9151	Rumsey	Rd	Columbia	21045	125	126	Other
Maryland School for the Deaf	8169	Old Montgomery	Rd	Columbia	21044	103	127	Other
Mt. Airy Christian Academy	16700	Old Frederick	Rd	Mt Airy	21771	285	128	Other
Nature's Way Children's Center	5890	Cedar	Ln	Columbia	21044	71	129	Other
Norbel School	6135	Old Washington	Road	Elkridge	21075	86	130	Other
Our Lady of Perpetual Help	4801	Ilchester	Rd	Ellicott City	21043	235	131	Other
Peter Pan Learning Center	1260	Driver	Rd	Marriottsville	21104	62	132	Other
Phillips School	8920	Whiskey Bottom	Rd	Laurel	20723	95	133	Other
Resurrection/St. Paul's School	3155	Paulskirk	Dr	Ellicott City	21042	534	134	Other
St. Augustine School	5990	Old Washington	Road	Elkridge	21075	238	135	Other
St. John's Parrish Day School	9130	Frederick	Rd	Ellicott City	21042	360	136	Other
St. Louis School	12500	State Route 108		Clarksville	21029	505	137	Other
The Young School	8310	Guilford	Rd	Columbia	21046	170	138	Other
Trinity School	4985	Ilchester	Rd	Ellicott City	21043	392	139	Other

(1) Used for 2015 Water and Sewer Master Plan Update.

(2) Corresponds to Figure 2-12

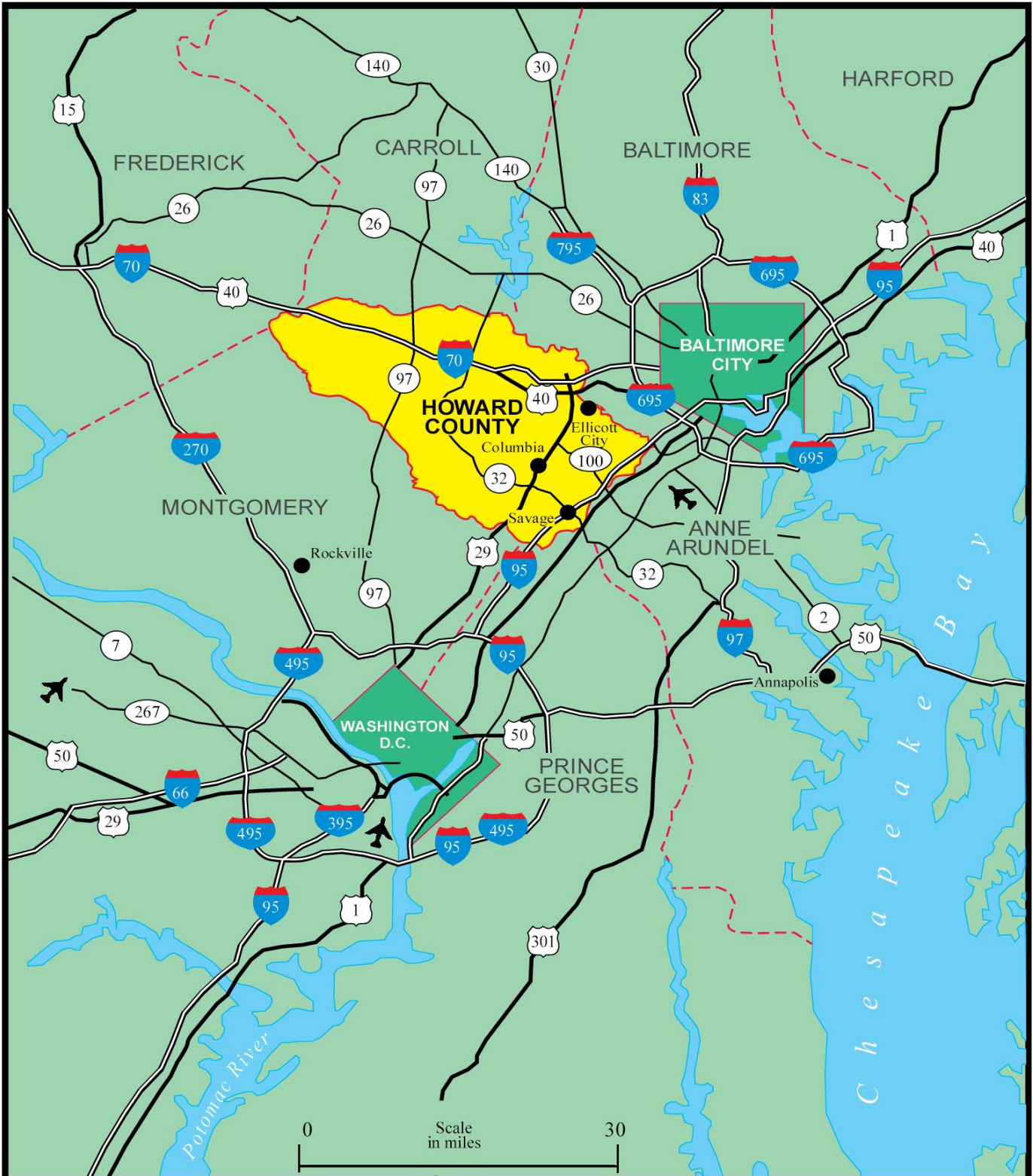

Howard County Regional Location



DISCLAIMER: Howard County, Maryland assumes no responsibility for the accuracy of this map or the information contained herein or derived there from. The user assumes all risks and liabilities whatsoever resulting from or arising out of the use of this map. There are no oral agreements or warranties relating to the use of this map.

FIGURE 2-1
November 2015

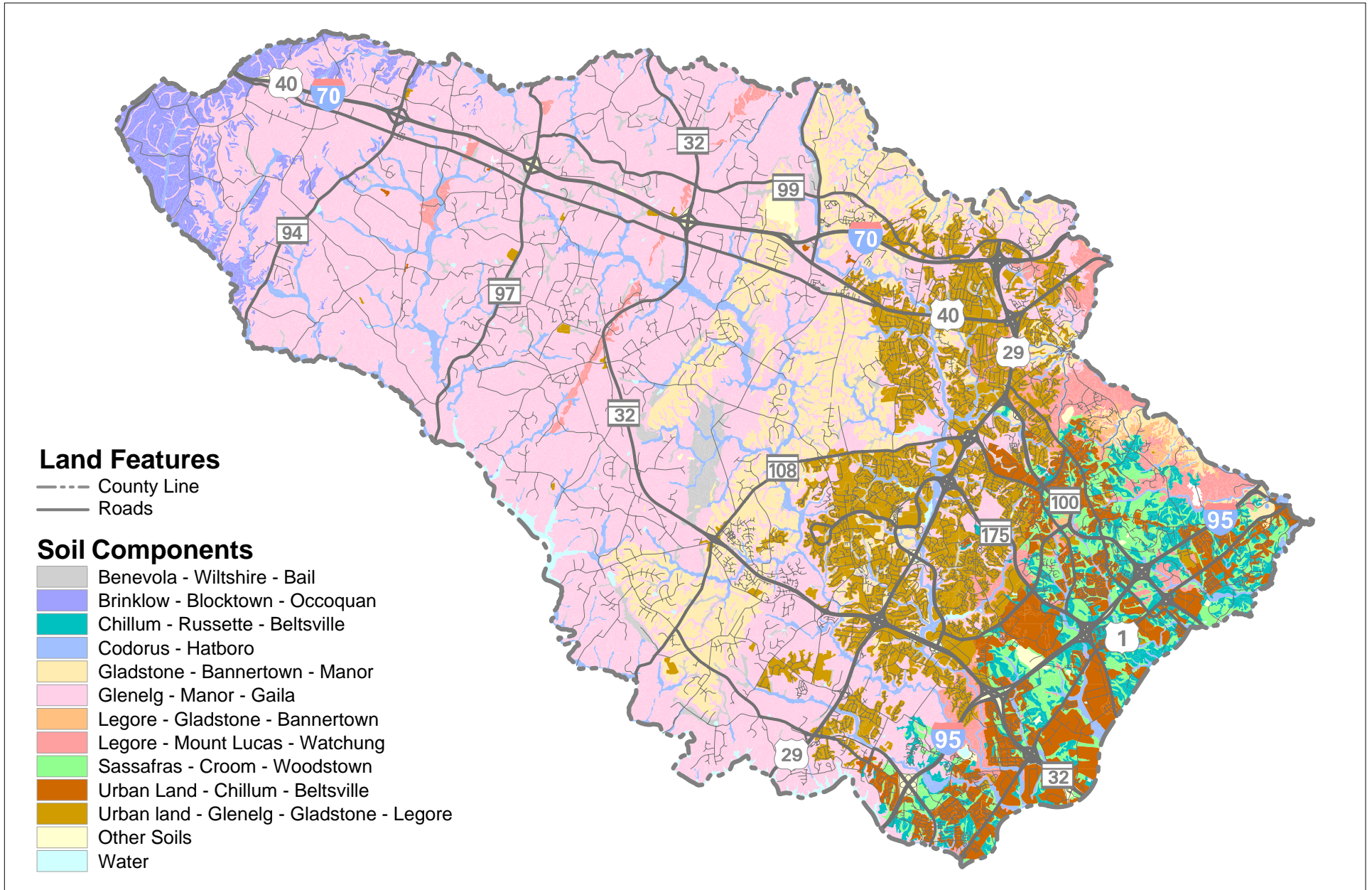

Geologic Formations

DISCLAIMER: Howard County, Maryland assumes no responsibility for the accuracy of this map or the information contained herein or derived there from. The user assumes all risks and liabilities whatsoever resulting from or arising out of the use of this map. There are no oral agreements or warranties relating to the use of this map.

Formations

Sedimentary Rocks	<ul style="list-style-type: none"> Alluvium & Colluvium Terrace Gravel Patuxent Formation
Intrusive Igneous Rocks	<ul style="list-style-type: none"> Diabase Pegmatite Guilford Granite Ellicott City Granite
Extrusive Igneous Rocks	<ul style="list-style-type: none"> James Run Formation Baltimore Complex
Metasedimentary Rocks	<ul style="list-style-type: none"> Pleasant Grove Formation Sykesville Formation Morgan Run Formation Gillis Group Prettyboy Schist Oella Formation Loch Raven Formation Cockeysville Marble Setters Formation Baltimore Gneiss

Other Features

	County Line
	Roads
	Water
	Thrust Fault
	Inferred Thrust Fault

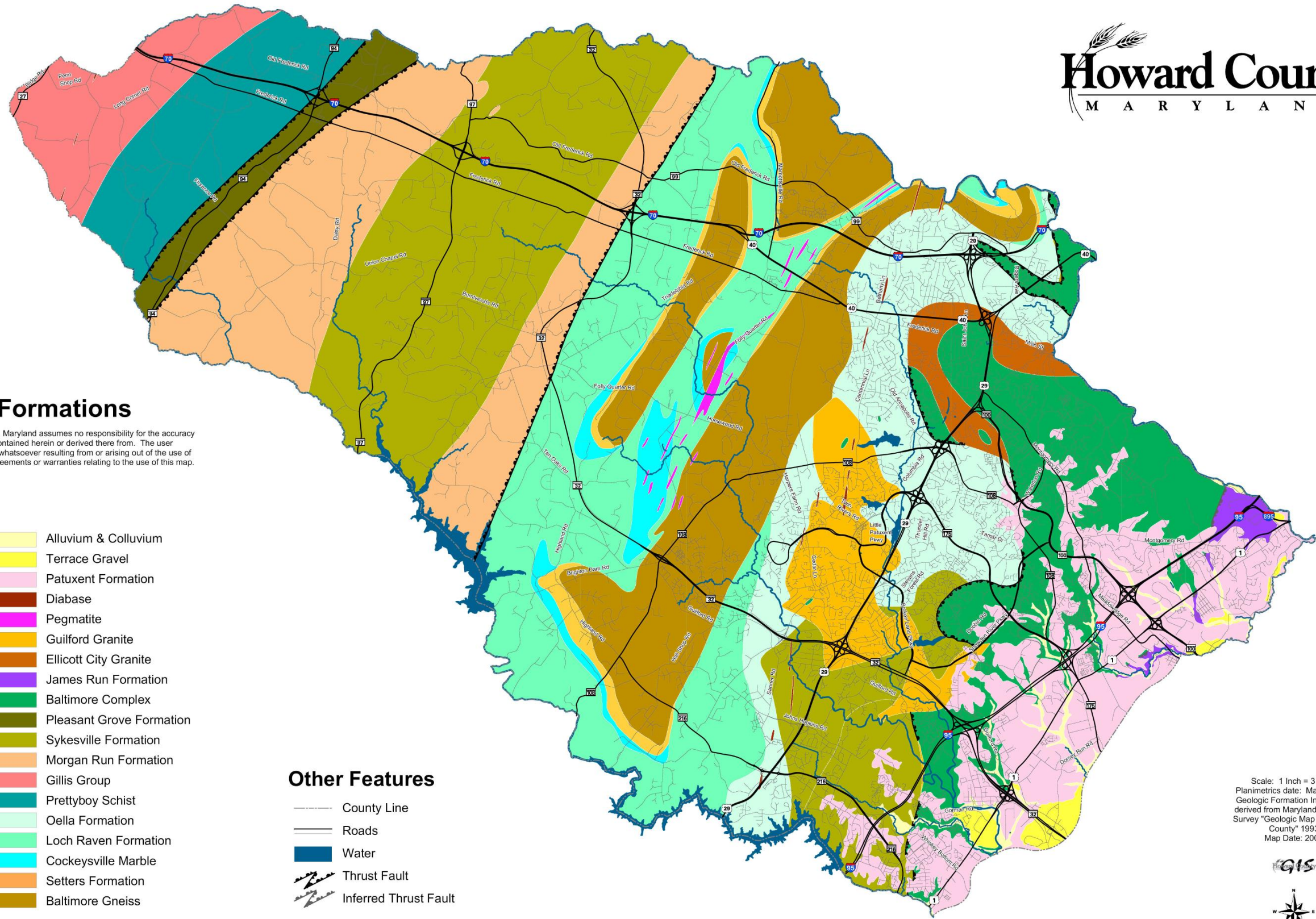

Scale: 1 Inch = 3 Miles
Planimetrics date: March, 2002
Geologic Formation Information derived from Maryland Geological Survey "Geologic Map of Howard County" 1993
Map Date: 2004



FIGURE 2-3
COUNTYWIDE GEOLOGIC MAP

Major and Sub Watershed Howard County, Maryland

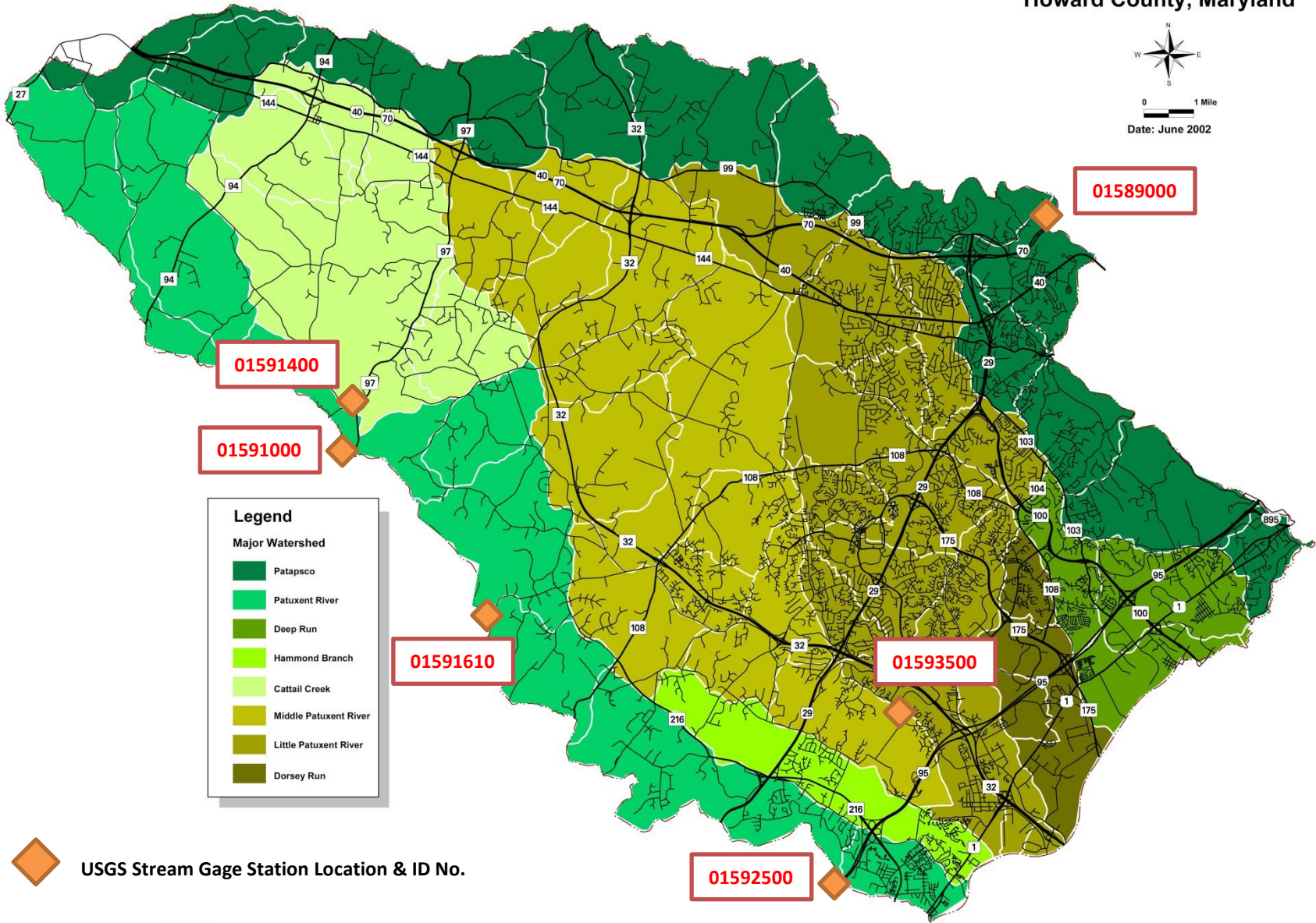

Legend

Major Watershed

- Patapsco
- Patuxent River
- Deep Run
- Hammond Branch
- Cattail Creek
- Middle Patuxent River
- Little Patuxent River
- Dorsey Run

USGS Stream Gage Station Location & ID No.

DISCLAIMER:
Howard County, Maryland assumes no responsibility for the accuracy of this map or the information contained herein or derived therefrom. The buyer and / or user assumes all risks and liabilities whatsoever resulting from or arising out of the use of this map. There are no oral agreements or warranties relating to this sale and / or use of this map.



**FIGURE 2-4
SURFACE WATER PATTERNS**

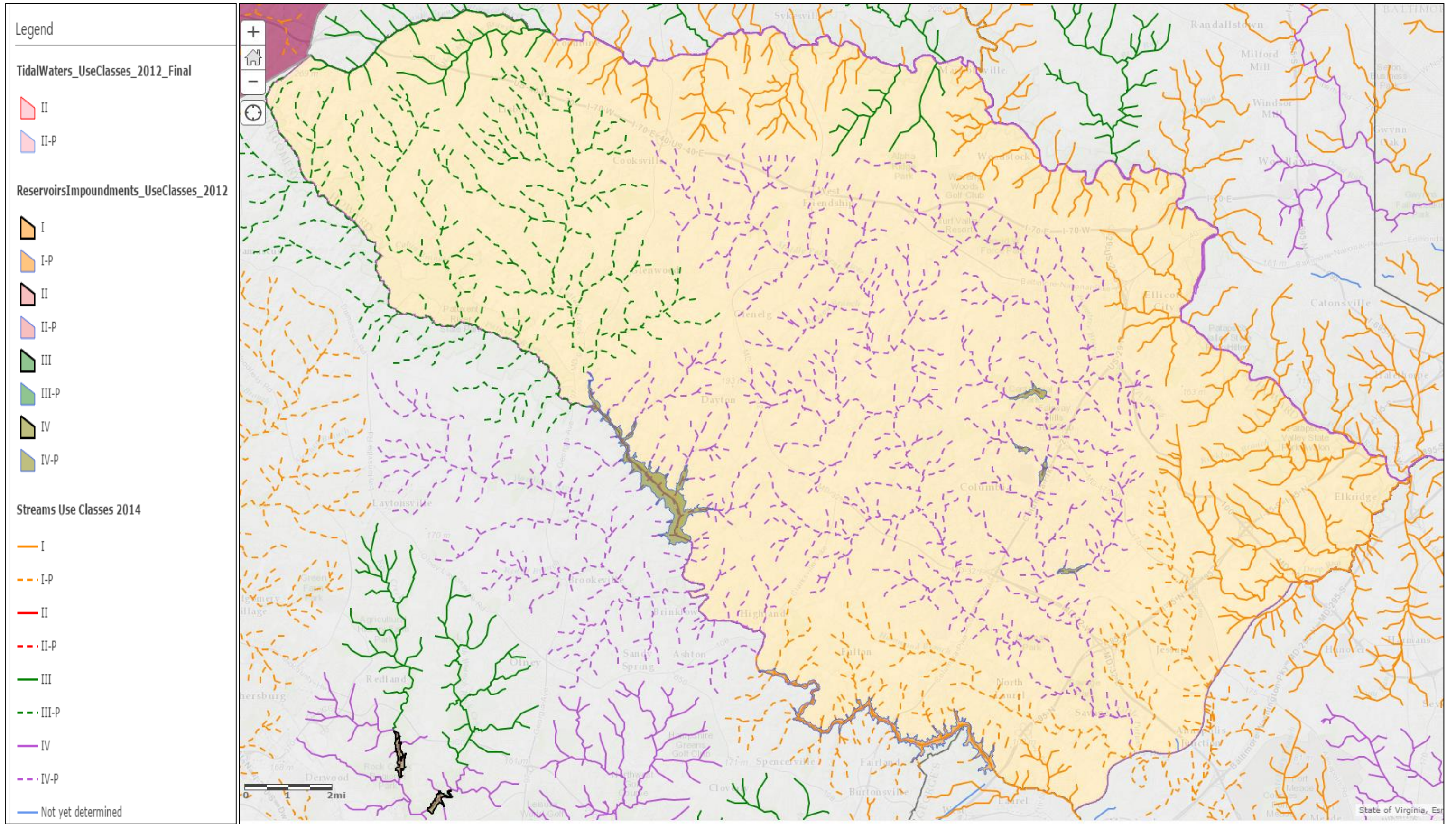

Designated Use Classes for Howard County Surface Waters (MDE 2012)

FIGURE 2-5
November 2015 Revision

Figure 2-6: Howard County Population Growth
Total Population: 1960 to 2010, Household Population: 2020 to 2040

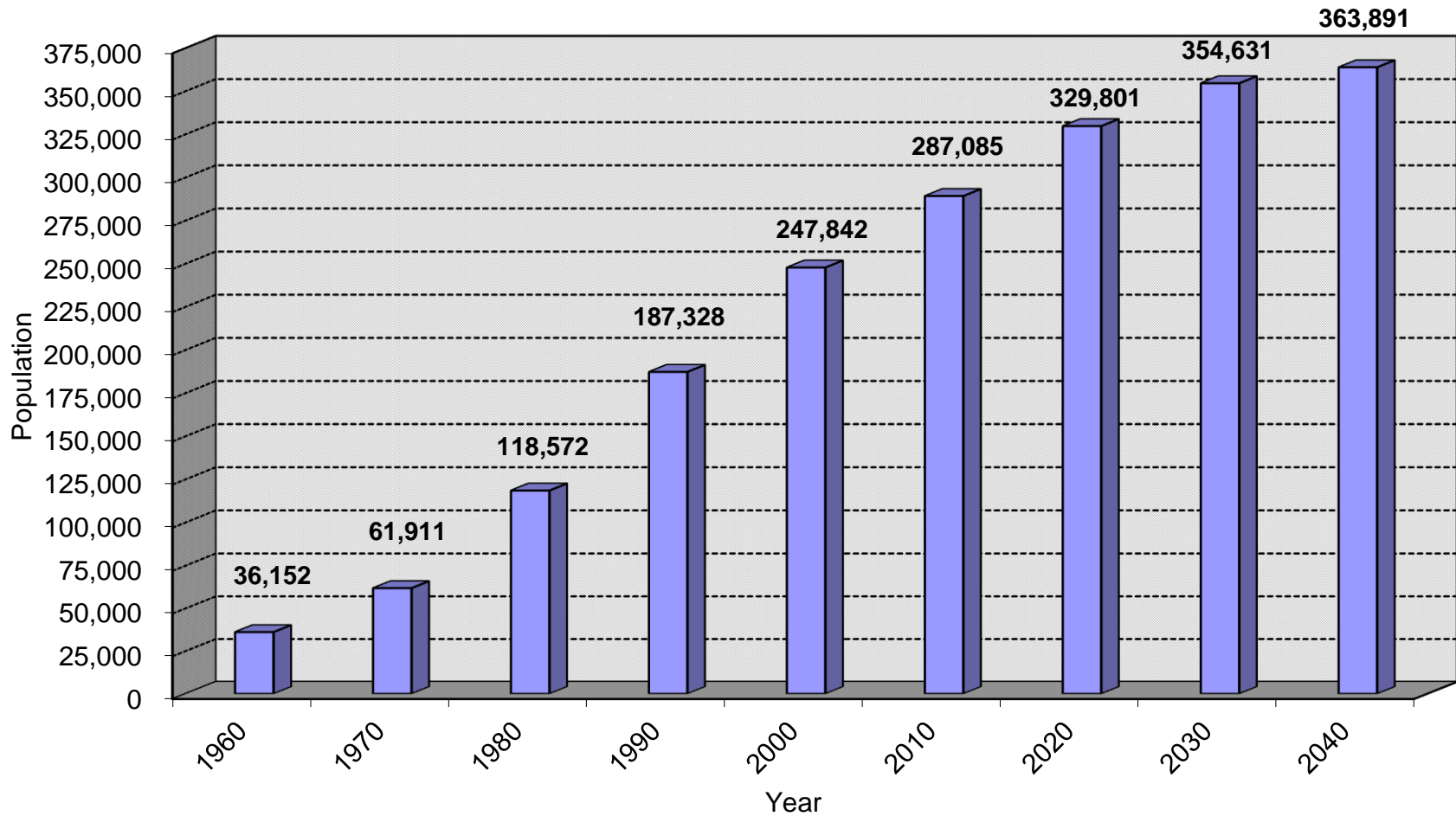

Source: US Census Bureau, Total Population: 1960 to 2010
DPZ Round 8A Household Population Projections: 2020 to 2040

Population Per Acre Projection Year 2015

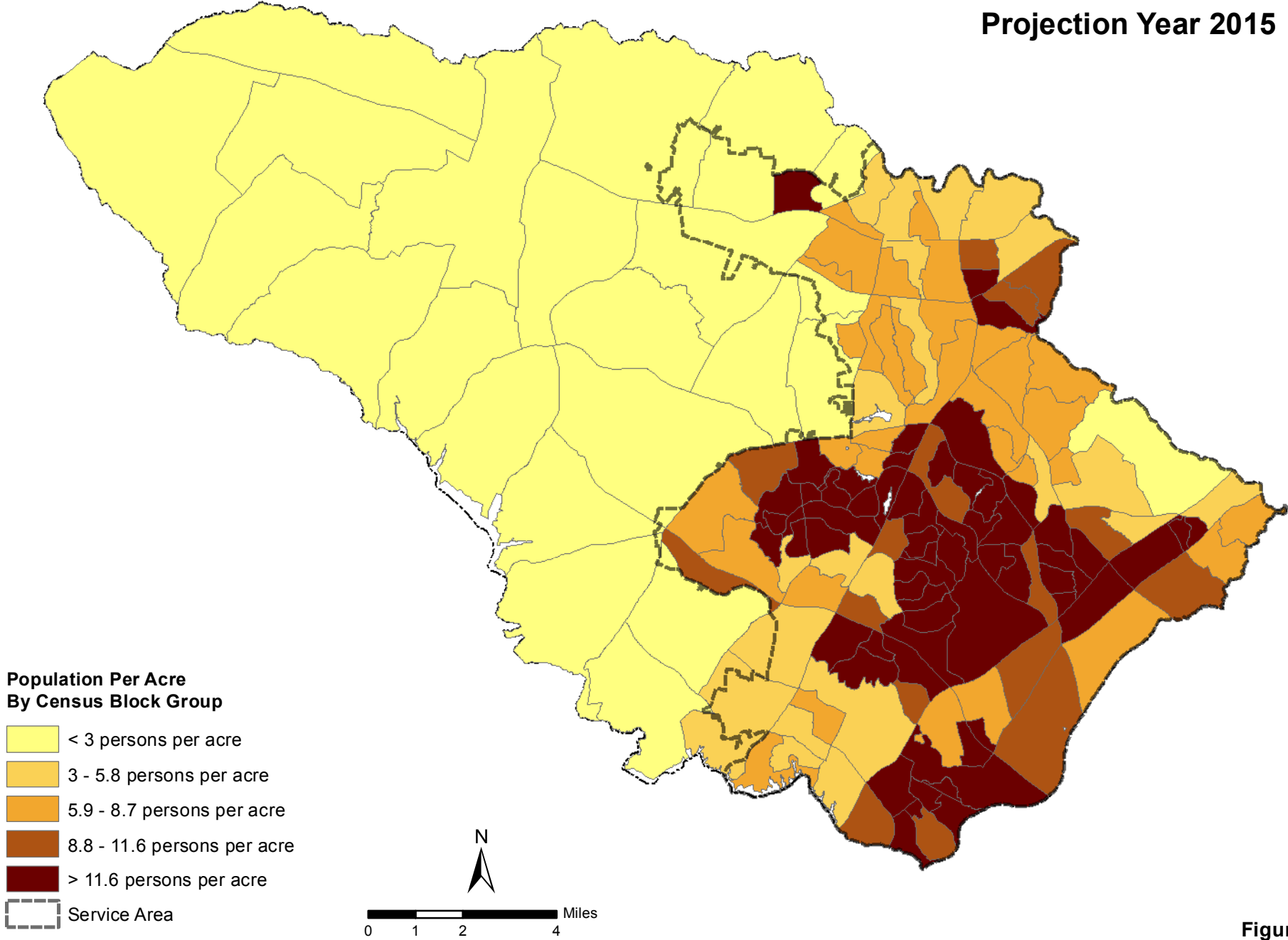

Figure 2-7

Population Per Acre Projection Year 2025

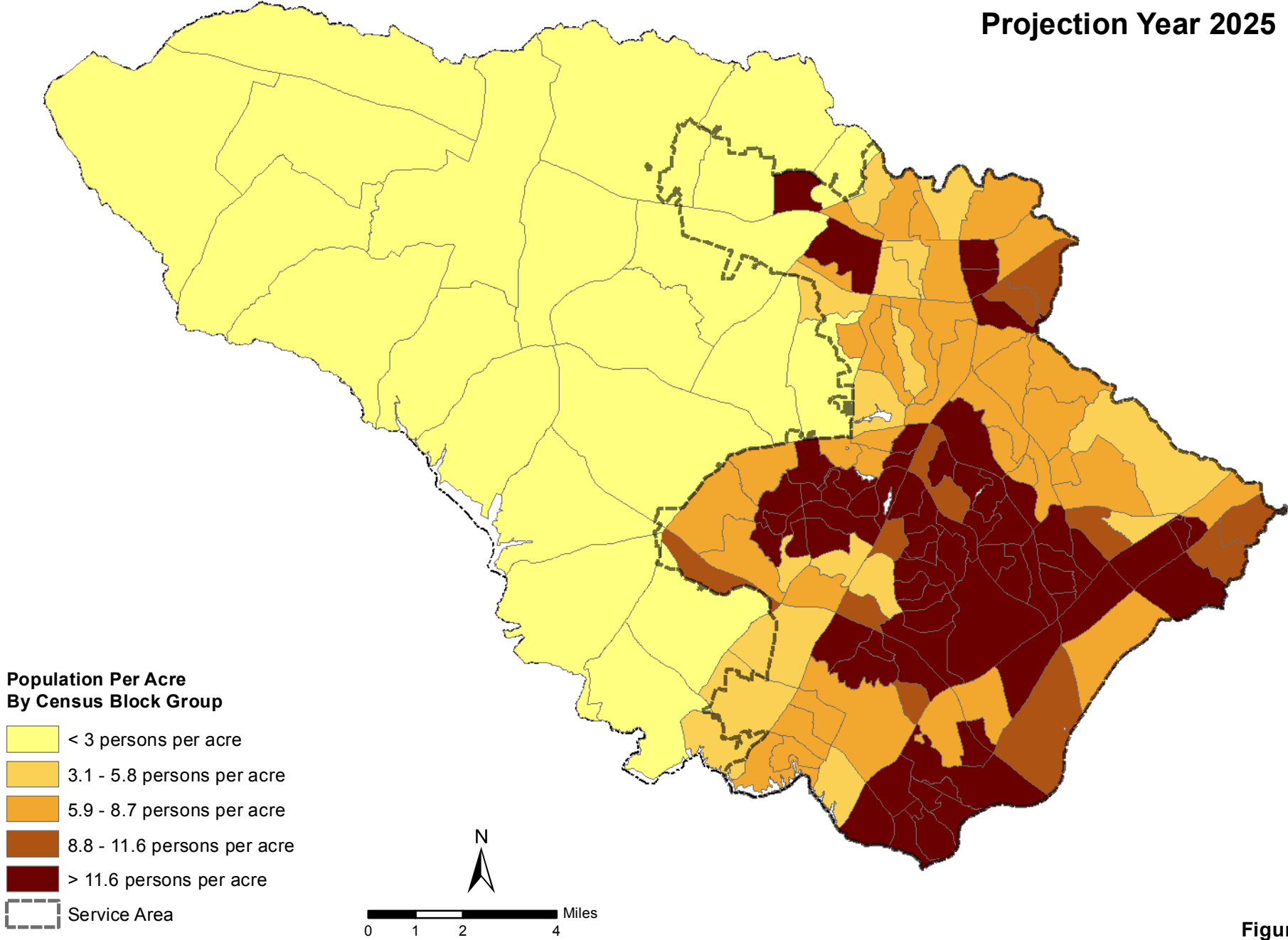

Figure 2-8

Population Per Acre Projection Year 2035

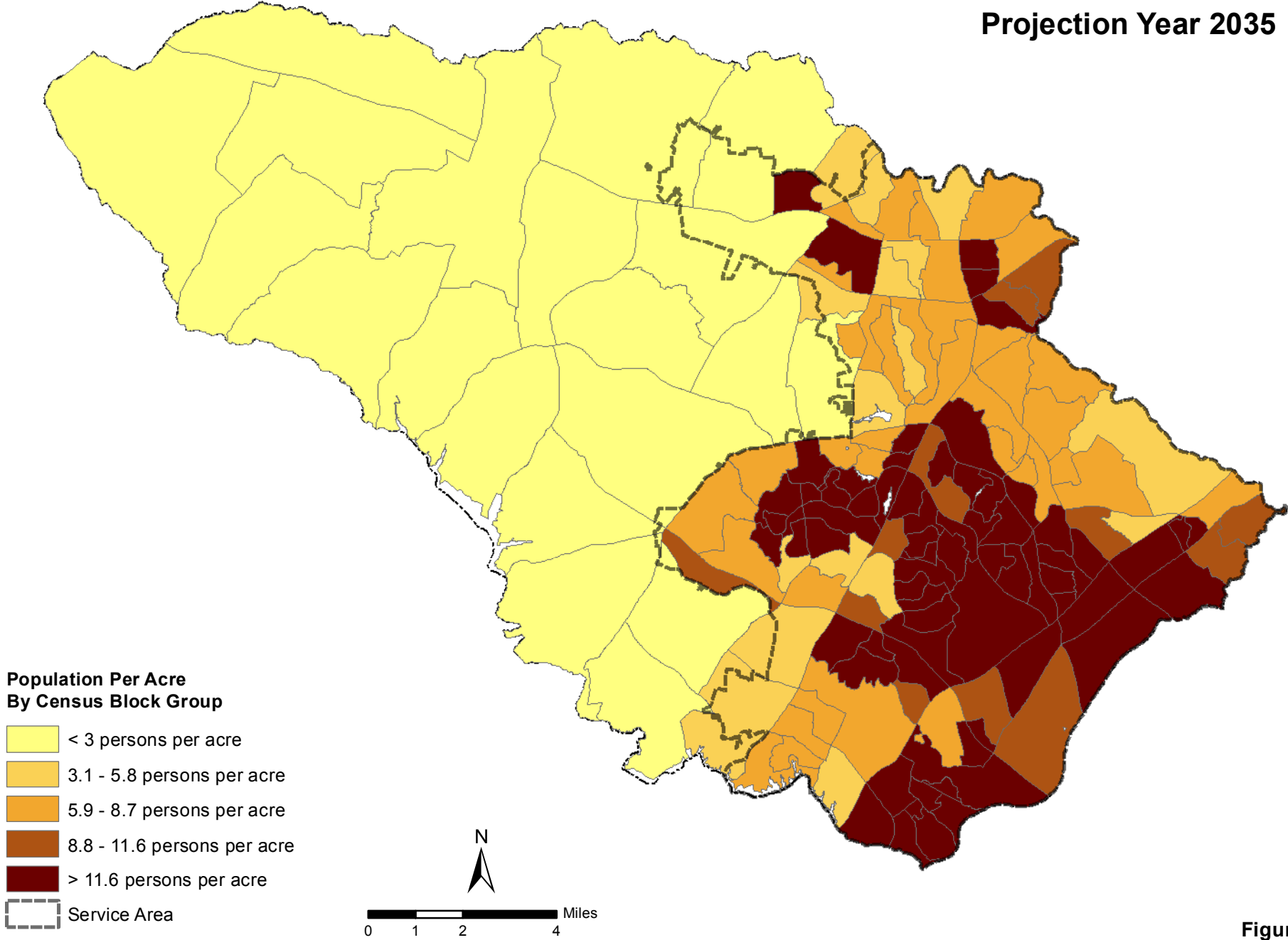
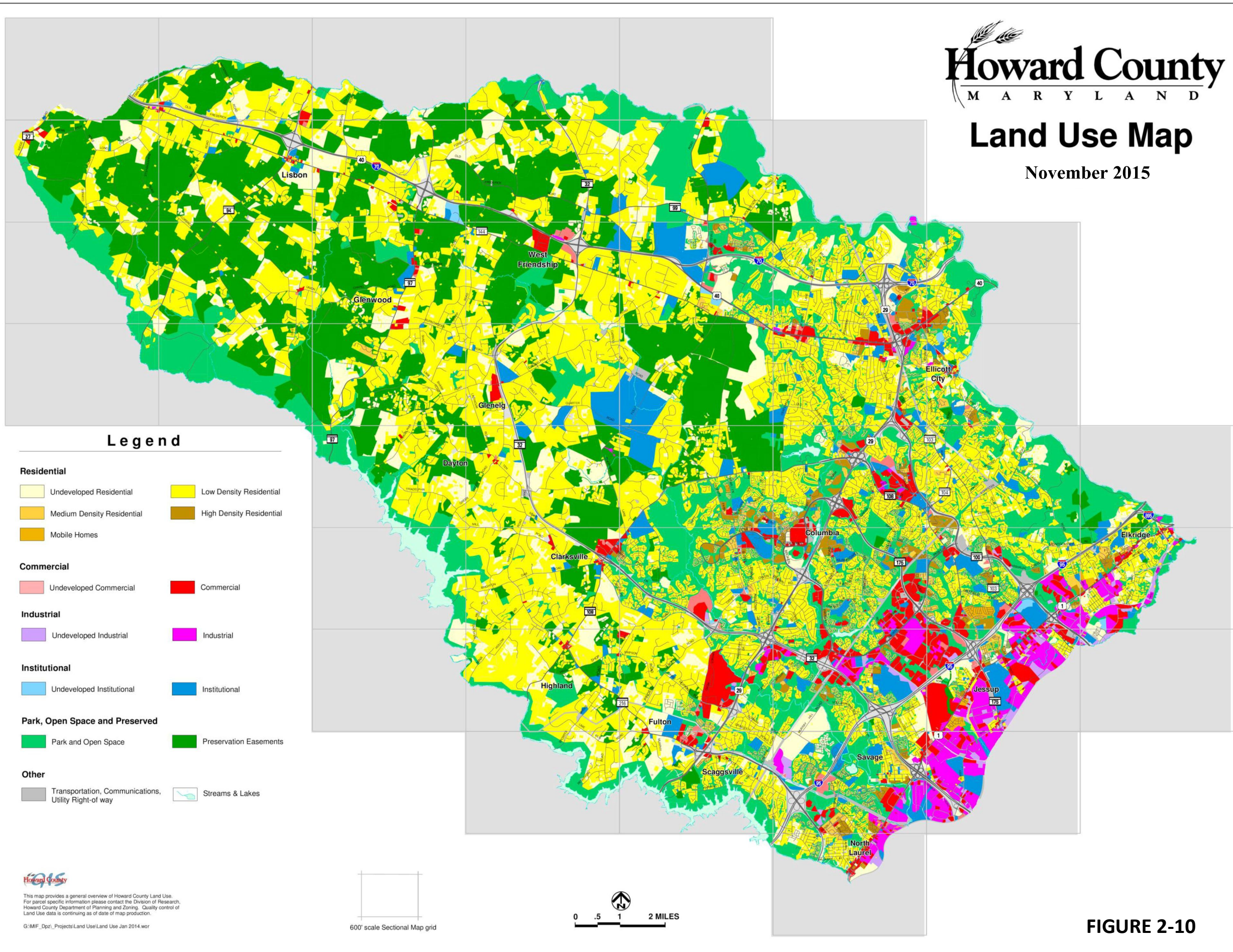

Figure 2-9

Land Use Map

November 2015



Legend

- | | |
|--|--------------------------|
| Residential | |
| Undeveloped Residential | Low Density Residential |
| Medium Density Residential | High Density Residential |
| Mobile Homes | |
| Commercial | |
| Undeveloped Commercial | Commercial |
| Industrial | |
| Undeveloped Industrial | Industrial |
| Institutional | |
| Undeveloped Institutional | Institutional |
| Park, Open Space and Preserved | |
| Park and Open Space | Preservation Easements |
| Other | |
| Transportation, Communications, Utility Right-of way | Streams & Lakes |



This map provides a general overview of Howard County Land Use. For parcel specific information please contact the Division of Research, Howard County Department of Planning and Zoning. Quality control of Land Use data is continuing as of date of map production.

G:\MIF_Docs_Projects\Land Use\Land Use Jan 2014.wor

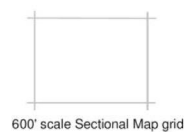
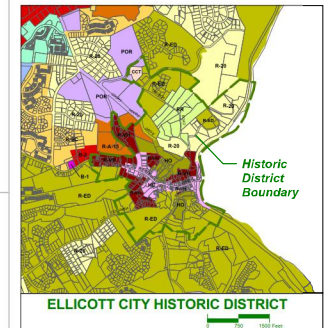
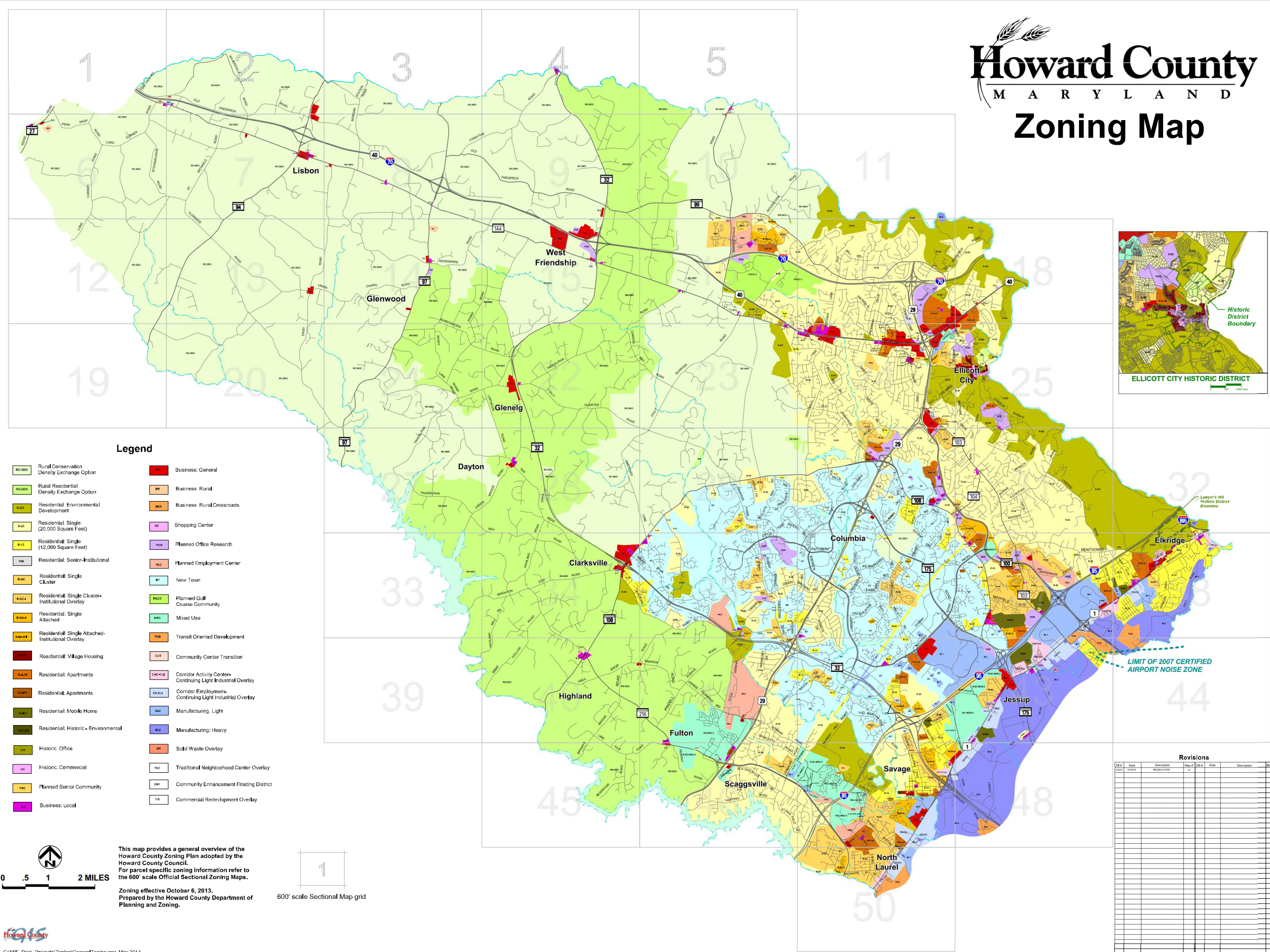
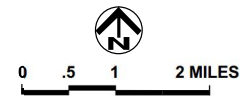

FIGURE 2-10

Howard County MARYLAND Zoning Map



- ### Legend
- | | |
|--|--|
| Rural Conservation Density Exchange Option | Business: General |
| Rural Residential Density Exchange Option | Business: Rural |
| Residential: Environmental Development | Business: Rural Crossroads |
| Residential: Single (20,000 Square Feet) | Shopping Center |
| Residential: Single (12,000 Square Feet) | Planned Office Research |
| Residential: Senior-Institutional | Planned Employment Center |
| Residential: Single Cluster | New Town |
| Residential: Single Cluster-Institutional Overlay | Planned Golf Course Community |
| Residential: Single Attached | Mixed Use |
| Residential: Single Attached-Institutional Overlay | Transit Oriented Development |
| Residential: Village Housing | Community Center Transition |
| Residential: Apartments | Corridor Activity Center-Continuing Light Industrial Overlay |
| Residential: Apartments | Corridor Employment-Continuing Light Industrial Overlay |
| Residential: Mobile Home | Manufacturing: Light |
| Residential: Historic - Environmental | Manufacturing: Heavy |
| Historic: Office | Solid Waste Overlay |
| Historic: Commercial | Traditional Neighborhood Center Overlay |
| Planned Senior Community | Community Enhancement Floating District |
| Business: Local | Commercial Redevelopment Overlay |



This map provides a general overview of the Howard County Zoning Plan adopted by the Howard County Council. For parcel specific zoning information refer to the 600' scale Official Sectional Zoning Maps.

Zoning effective October 6, 2013.
Prepared by the Howard County Department of Planning and Zoning.

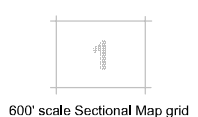

Revisions					
Drawn	Date	Description	Map #	Date	Description

Figure 2-11

Howard County

Water and Sewer Update
2015

Major Public Institutions

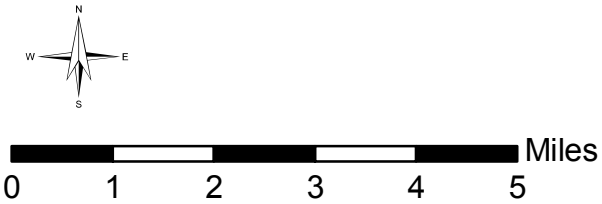
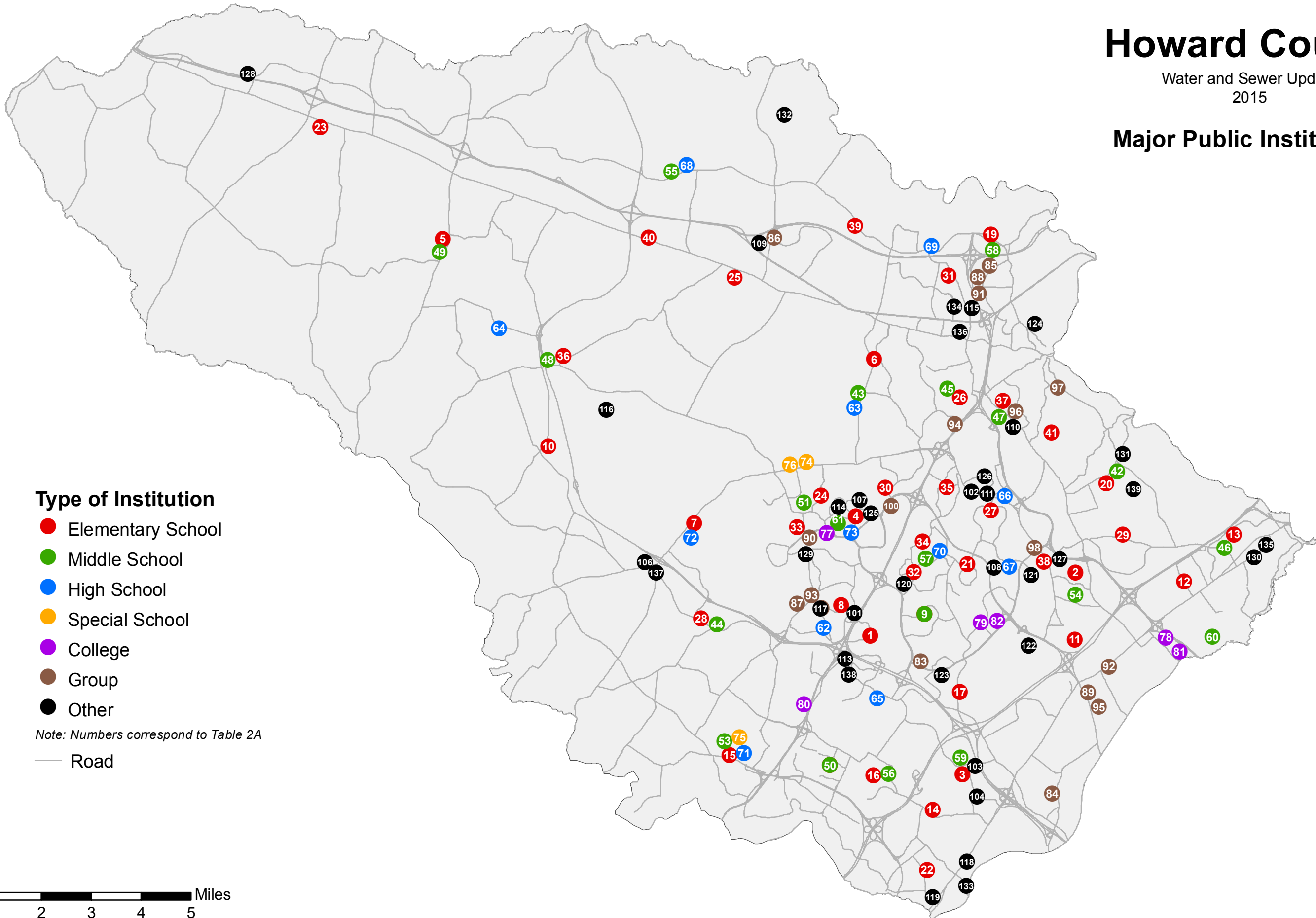

Figure 2-12

CHAPTER 3

THE WATER PLAN

The purpose of this Chapter is to review the County's existing water system and determine the County's future water system requirements. Howard County depends upon Baltimore City and the Washington Suburban Sanitary Commission (WSSC) for all of its public potable water supply. The basis for these supplies is a series of negotiated legal agreements.

3.1 Water Requirements

The present annual average daily water requirement for the County is estimated at 25.5 million gallons per day (MGD). Approximately 22.6 MGD is supplied through the public system, which serves 86% of the County's population. The remainder of the County population is served by private wells or surface water supplies that produce an estimated 2.9 MGD. The projected population served by the water system is listed in Table 1, Chapter 2.

Existing water meter records (both water purchased by the county and water usage) are used to determine residential consumption, commercial/industrial consumption, and public consumption. **Table 3A "Average Daily Water Demand Projections"** shows the portion of total water use for each usage category through the year 2040. Existing unaccountable water use is determined as the difference between water usage metered in Howard County and water purchased by Howard County from Baltimore City and WSSC, less other non-metered authorized uses. Unaccountable water use includes leaks, water main breaks, storage tank overflows, water meter under-registration, and theft. Howard County's unaccountable water for the calendar years 2011, 2012 and 2013 was 5.8%, 10.7%, and 11.6%, respectively.

Table 3 "Projected Water Supply Demands and Planned Capacity" compares the population and total water use projections from Table 3A to contracted supplies at each of the County's connections with Baltimore County and WSSC. Included is an estimate of the future contracted supply at each connection for each design year, through the year 2040. Capacity increases at each connection will depend on the multi-jurisdictional legal agreements and financial commitments as described herein.

Table 3B "Projected Average Daily Demand and Contracted Average Daily Supply" makes a direct comparison between contracted supply limitations and the projected demand at each connection. Projected demand in this case is the demand determined by hydraulic analysis of the water system. This computerized analysis allows water tanks to fill or empty and pumped flows to vary with discharge head over an extended period. The analysis is discussed in greater detail later in this chapter.

The Howard County Plumbing Code complies with the Annotated Code of Maryland, Article 56, Section 445 - Water Conserving Fixtures. The Inspections and Enforcement Division of the Department of Inspections, Licenses and Permits conducts plumbing inspections within the County. A separate inspection for fixtures is conducted and approval/disapproval is noted on the inspection record. The inspector's approval signature on the inspection record officially certifies that all fixtures in the residence and their installation comply with the current adopted edition of the National Standard Plumbing Code Illustrated and local amendments incorporated in the Howard County Code.

Howard County inspectors do not approve an inspection if water conservation devices are not installed. If non-conserving water devices are installed, a notice of violation is issued. If the violation is not corrected at the time of re-inspection, a civil citation is issued. Neither a temporary nor final certificate of occupancy is issued to the owner until water conservation fixtures have been installed.

3.2 Existing Water Supply Facilities

Howard County's water system is the only public water system within the County. The other facilities in the County, as listed in **Table 6**, are relatively small privately owned systems. Withdrawals from private well systems and the few surface water supplies are expected to decrease from their present rates in the eastern portion of the County, as the public system expands. This is the result of users in the Metropolitan District abandoning their private wells and connecting to the public system. No other significant well supplies are anticipated.

The City of Baltimore and WSSC supply all of the potable water to the Howard County public system. The County's system is currently supplied through four (4) connections to the Baltimore County water system (which in turn is supplied from the Baltimore City system) and through one (1) connection from WSSC's system. Howard County both owns and operates the distribution system within its boundaries. The development, operation and maintenance of the water supply facilities, treatment plants, and distribution system located outside of Howard County are the responsibility of Baltimore

County, Baltimore City or WSSC as appropriate. Howard County participates in the planning, development, and capital costs of improvements to the public potable water system with these other jurisdictions.

3.3 Howard County's Existing Water System

Howard County's existing water system is divided into nine water pressure zones. Areas are placed in the water pressure zones based on ground elevations. The water supplied to each zone is maintained at a pressure sufficient to provide adequate service to the homes and businesses in each zone. Each zone is supplied by one or more water pumping stations or pressure reducing valves, which are needed to raise or lower the water pressures adequately to maintain pressure and fire flow capabilities in that zone. A schematic diagram of the County's existing water system is included as **Figure 3-1** and locations of the water pressure zones are shown on **Figure 3-2**.

A. 300 Pressure Zone

This pressure zone consists of lower Elkridge. A 2-inch and a 6-inch Pressure Regulating Valve (PRV) located in the same vault provide domestic service and fire protection for the zone from the 400 Zone, with a pressure relief valve for over-pressure protection. There is no water storage in this zone.

B. 350 Pressure Zone

This zone consists of historic Ellicott City. There are no water storage tanks in this zone, and three PRVs. The Main Street PRV, College Ave PRV, and Sarah's Lane PRV serve this zone from the 550 Zone. A pressure relief valve located near the Main Street PRV provides over- pressure protection for the zone.

C. 400 Pressure Zone

The 400 pressure zone extends from North Laurel in the south, to Elkridge in the north, east of Interstate 95. Water storage in this pressure zone consists of one existing tank, the Greater Baltimore Food Market (GBFM) Elevated Water Tank (EWT), and one future tank, the new Guilford EWT, currently in design under capital project W-8262. The storage capacity of each tank is 0.75 and 2.5 million gallons (MG) respectively. The 400 Zone has two main supplies, including the WSSC supply through the All Saints Water Pumping Station (WPS) (gravity service and pumped), and the River Road/Gun Road supply from Baltimore City (through the River Road PRV). In addition, pressure regulating valves at Meadowridge Road, Hunt Club Road, Huntington East, Gorman

Road, and Whiskey Bottom Road supply water from the 550 Zone. Two standby pumping stations, Rt. 32 WPS and Whiskey Bottom WPS, are available to provide supply from the 400 Zone to the 550 Zone.

D. 550 Pressure Zone

This is the Howard County water system's primary pressure zone with water storage consisting of two elevated water tanks; the Snowden River EWT, and the Scaggsville EWT with capacities of 2.0 MG and 3.0 MG respectively. This zone encompasses the center portion of the County's metropolitan district and extends from Ellicott City in the north to Scaggsville in the south along the US Rt. 29 corridor, encompassing most of Columbia. Water from Baltimore City's Western Third Zone enters the 550 Zone from the 20 MG Catonsville reservoir by gravity through parallel 48 and 24-inch connections along US Route 40 at a maximum gradient elevation of 567 feet. The Rt. 29 pumping station delivers water to both tanks, and can be controlled from the level of either tank.

A second water supply for the 550 Zone is from the Baltimore City Second Zone via the Southwest Transmission Main (Elkridge connection) that has a maximum gradient elevation of 353 feet. The supply is pumped into the 550 Zone by the Elkridge pumping station, with a maximum supply rate of 18 MGD.

Water from the 550 Zone is redistributed to the other pressure zones by water pumping stations (WPS, for higher elevations) or pressure regulating valves (PRV, for lower elevations).

E. 560 Pressure Zone

This pressure zone was established to serve the Hollifield Estates subdivision on Old Frederick Road. Three (3) inch and six (6) inch PRVs, located in the same vault, provide domestic service and fire protection for the zone from the 630 West Zone. There is no water storage in this zone.

F. 630 East Pressure Zone

The 630 East pressure zone consists of the Oakland Ridge area bounded by the southern part of Ellicott City to the north, College Avenue to the east, Rt. 29 to the west, and Rt. 175 to the south. This zone utilizes two existing elevated water tanks; Oakland Ridge and Jonestown, 1.5 and 0.2 MG respectively. Two pumping stations serve this zone and draw suction from the 550 Zone, Montgomery Road WPS and Edgar Road WPS.

G. 630 West Pressure Zone

The 630 West pressure zone encompasses the northern and western sections of Ellicott City, and extends south covering the western part of Columbia and Clarksville. Storage in this zone consists of three existing elevated water tanks; Bethany EWT, Harpers Choice EWT and Marriottsville Road EWT, 0.2 MG, 1.0 MG and 1.25 MG respectively. Three pumping stations serve this zone and draw suction from the 550 Zone; Chestnut Hill WPS, Pine Orchard WPS, and Columbia WPS.

H. 630 South Pressure Zone

The Fulton community is located west of US Route 29 between Johns Hopkins Road and MD Route 216. The western boundary of this area is just east of Pindell School Road. Approximately one-third of this area is served by the extension of existing mains in the 550 Zone. However, the remaining portions are too high in elevation to be served from this zone. A new pressure zone, the 630 South Zone, was created to serve this area. The Route 216 pumping station, with a capacity of 0.3 MGD, and the Maple Lawn pumping station, also with a capacity of 0.3 MGD, provide water to the 630 South Zone from the 550 Zone. The 0.5 MG Fulton EWT was constructed along Rt. 216 to serve the 630 South Zone.

I. 730 Pressure Zone

The 730-pressure zone is in the area of Ellicott City west of Marriottsville Road. This zone contains one elevated water tank, the Alpha Ridge EWT with a 0.3 MG storage capacity. Two pumping stations drawing from the 630 West Zone, the Frederick Road WPS and the Marriottsville Road WPS constructed in conjunction with the Marriottsville Road EWT, serve this zone. This zone is mostly in a “water only” area. The expansion of public sewer into a portion of this zone was recently approved under PlanHoward 2030. An upgrade to the Frederick Road WPS was completed under capital project W-8264.

J. Water Service Priority Categories

As specified in Chapter 1, parcels of property in the Planned Service Area are assigned water service priorities. Periodically, the Master Plan is amended to account for changes in service priorities as a result of subdivision and land development activity and capital construction. The WATER FACILITIES PLAN MAP and the accompanying Table of Water Facilities Map Revisions provided in EXHIBIT 1 have been revised and updated to show service priority revisions for County capital and private development activities

through December 2014. The following types of revisions have been incorporated into the 2015 Water & Sewer Master Plan as shown on the WATER FACILITIES PLAN MAP:

1. Changes in Capital Project Scopes and Schedules- As capital projects progress from the planning phase to construction, the priority designations assigned to the properties served by these projects must be updated. The criteria for determining the appropriate priority designations are described in Chapter 1.
2. Changes in Status of Private Development- As planned private development progresses through the plan review and approval processes administered by the Department of Planning & Zoning (DP&Z), the Master Plan priority designations for affected properties must be revised and updated in accordance with Chapter 1 criteria. These revisions are of particular importance since the Maryland Department of Environment will only approve water or sewer construction permits for proposed development that is assigned a priority that specifies service within five years.
3. Entries into and Removals from the Metropolitan District- Properties that have been incorporated into the Metropolitan District, or removed from the Metropolitan District require revision of the Metropolitan District boundaries shown on the Water Facilities Plan Map.
4. Addition to the Planned Service Area- Properties that have been added to the Planned Service Area in accordance with amendments to the Howard County General Plan 2000 and adoption of PlanHoward 2030 are incorporated into the Planned Service Area for Water to provide consistency with the General Plan. Refer to the Planned Service Area section in Chapter.1

3.4 City of Baltimore Supply

The primary source of water to Howard County from the City of Baltimore is the Ashburton Filtration Plant. The Ashburton Plant was placed in service in 1956 and is located on Druid Park Drive in Baltimore City. This plant has a raw water treatment capacity (peak) of 165 MGD, with four flocculators, four sedimentation basins, and twenty rapid sand filters.

The raw water supply to the Ashburton Filtration Plant is Liberty Reservoir located on the north branch of the Patapsco River. The reservoir has a storage capacity of 43 billion gallons and a safe yield of 93.0 MGD. Water from Liberty Reservoir flows by gravity through a concrete lined tunnel, 13 miles in length and 10 feet in diameter, to the filtration plant where it is stored in the 220 million gallon capacity Lake Ashburton Reservoir.

Water supplied to Howard County is pumped by the Ashburton and Leakin Park Pumping Stations. The Ashburton Pumping Station houses four 28 MGD pumps and has an apparent safe capacity of 84 MGD. However, system hydraulic constraints limit the maximum safe pumping station output (with three pumps operating and one pump held in reserve) to approximately 81 MGD. This flow rate was realized during the maximum day demand which occurred in June, 1986.

The Leakin Park Pumping Station, which went into operation in 1991 and was expanded in 2007, houses five 20 MGD pumps. The current safe capacity of the station is 80 MGD, using four pumping units with one standby unit.

The maximum combined output of the Leakin Park and Ashburton Pumping Stations was 102.6 MGD on July 15, 1995 prior to the expansion of the Leakin Park Pumping Station and completion of the parallel Catonsville Water Transmission Main in 2008. The flows through the Ashburton and Leakin Park Pumping Stations on that day were approximately 59 MGD and 44 MGD, respectively.

Baltimore City supplies water through Baltimore County to Howard County through four (4) connections: the Gun Road connection, two Route 40 connections, and the Elkridge connection. Howard County is billed on the basis of monthly meter readings and, in each case, the meter is located in Baltimore County near the boundary with Howard County.

The Gun Road connection was established by the August 14, 1934 Agreement between Baltimore City and Howard County (the 1934 Agreement). This agreement does not contain specific withdraw limitations although it has been assumed that an average daily flow of 1 MGD and a maximum daily flow of 1.7 MGD is allowable. The sources of supply are transmission mains from the Ashburton Pump Station. The connection originates in the Western Third Zone at Gun Road, crosses the Patapsco River, follows River Road to Lawyers Hill Road and, through the River Road pressure reducing valve, supplies the Howard County 400 pressure zone via Levering Avenue.

The Route 40 connection was originally established by the November 6, 1957 Agreement between Baltimore County, Baltimore City, and Howard County. By this agreement, Howard County was entitled to an average flow of 5.0 million gallons per day and a

maximum of 8.5 million gallons per day from the Western Third Zone. A new Third Zone Agreement executed on July 9, 1986 lifted this flow restriction. Under the new agreement, Howard County may exceed its previously specified maximum daily withdraw rate as long as unused capacity is available in the Western Third Zone. The agreement provides for an ultimate maximum day capacity of 50.5 MGD for Howard County from the Western Third Zone.

Specific improvements to the water system in the Western Third Zone have been built in accordance with the 1986 Agreement. Expansion of the Leakin Park Pump Station was completed in 2007 and construction of the parallel 48 & 42-inch diameter Catonsville Water Transmission Main was completed in 2008 to supply a maximum day demand of 50.5 MGD (48.8 MGD from the U.S. Route 40 connection and 1.7 MGD from the Gun Road connection) to Howard County. This capacity along with the capacity available from the County's other connections will satisfy Howard County's needs at build-out of the planned service area. Baltimore City does not, in general, cost-share in the new Western Third Zone improvements since these facilities will provide additional capacity for Howard and Baltimore Counties only. The City will, however, share in the cost of the following facilities:

1. Any local facilities within the City associated with construction of the Western Third Zone improvements.
2. Maintenance and rehabilitation of existing Western Third Zone facilities shared by the City.

Construction of the parallel Catonsville Water Transmission Main, Sections 1 through 4, was funded entirely by Howard County since the sole purpose was to provide increased capacity between the Leakin Park Pumping Station and the Howard County border.

The sources of the Western Third Zone supply to Howard County are transmission mains from the Ashburton and Leakin Park Pump Stations to the Howard County line at the Patapsco River. The Route 40 connection draws from the Central System's Western Third Zone at U.S. Route 40 and the Patapsco River to supply the County's 550 pressure zone.

The Elkridge connection was established by the October 22, 1969 Agreement between Baltimore County, Anne Arundel County, Howard County, and Baltimore City (the Second Zone Agreement). The cost of constructing three subsections of the related transmission mains was apportioned by a January 30, 1980 amendment between Baltimore County, Anne Arundel County, Howard County, and Baltimore City (the

Second Zone Amendment). Howard County is entitled to an average use of 8.8 million gallons per day and a peak hour demand of 17.6 million gallons per day through this connection. The connection originates in the Second Zone which receives treated water primarily from Lake Ashburton, which is supplied by the Ashburton Filtration Plant. The Second Zone also receives treated water from the Central System's First Zone via the Vernon Pump Station when the Ashburton Filtration Plant is unable to provide the complete needs of the Second Zone by itself. Similarly, the Hillen Road Pump Station also transfers water from the First Zone to the Second Zone. The Elkridge connection is supplied via the Southwest Transmission Main, crossing the Patapsco River and following River Road and Rockburn Branch to the Elkridge Pump Station, which supplies the County's 550 pressure zone.

3.5 WSSC Supply

WSSC supplies water to Howard County through the All Saints Road connection. A meter located in Howard County provides the basis for monthly water use billing by WSSC. The connection was originally established by the October 25, 1954 Agreement between WSSC and Howard County (the 1954 Agreement). Howard County was entitled to a maximum withdraw rate on any given day of 2.5 MGD under the 1954 Agreement, and is charged a volumetric rate equal to 70% of the prevailing retail rate charged to WSSC customers, based on a 240 gallons per day per household (gpd/household) usage rate .

WSSC agreed by letter dated December 24, 1986, on an interim basis, to allow Howard County a maximum daily withdraw rate of 3.5 MGD pending execution of a long-term agreement. This was followed by a long term agreement between Howard County and WSSC which was executed June 16, 1988. The 1988 Agreement replaced the 1954 agreement. It revises outdated provisions of the 1954 Agreement and provides for an increase in the allowable maximum daily flow through the All Saints Road connection to 5.0 MGD. As part of the new agreement, Howard County contributed towards the construction of a 12" water main along Montgomery Street in Laurel. This main will ensure that a 330 ft. hydraulic grade can be maintained at the suction side of the All Saints Road Pump Station under anticipated flow conditions. In addition, this main will provide a second suction main to the pump station which will guard against service interruption in the event of a main break.

Based on the observed ratio of 1.5-to-1 for maximum day to average day flow and a maximum day draw of 5.0 MGD, the allowable average day withdrawal equals 3.3 MGD. This amount of water will be available at normal system operating pressure except during

unusual or emergency conditions. The agreement provides for additional capacity of up to 10 MGD, if requested by Howard County and approved by the WSSC.

With current reserved capacity of 5 MGD, the additional 5 MGD would not be reserved and used only when conditions in the WSSC distribution system permit. This is as a result of WSSC's desire to utilize excess capacity in its Patuxent Water Treatment Plant (currently rated at 56 MGD), and Howard County's desire to have additional useable sources to meet both existing and emergency needs. In the event an Agreement is put in place, Howard County will need to significantly upgrade the All Saints pumping station to increase the supply into the County's 400 Zone, the Whiskey Bottom and Rt. 32 pumping stations to pump additional capacity into the 550 Zone, and interconnecting transmission mains for distribution.

The First Addendum to the 1988 Agreement was passed in 2008. Under the First Addendum, a six-month pilot program was conducted for Howard County to test the capacity of its equipment and facilities, and to determine what portion of its withdrawal allotment it could guarantee to utilize on a daily basis. A Second Addendum to the 1988 Agreement was passed in 2009. This Addendum establishes the billing rate and the withdrawal amounts between WSSC and Howard County. Under the Second Addendum, Howard County agrees to purchase a minimum of 2.5 MGD, regardless of the actual withdrawal rate, and at the same billing rate as charged by Baltimore City. The maximum daily withdrawal rate remains 5.0 MGD.

The raw water source for the WSSC supply is the T. Howard Duckett Reservoir on the Patuxent River. Water is treated at the Patuxent Water Filtration Plant, then conveyed east through a 24-inch main which branches to a 16-inch main with a 12 inch backup loop to the County's 400 pressure zone. The 16-inch main connects to the All Saints Road Pump Station which currently has a capacity of 5.0 MGD.

The WSSC water supply hydraulic gradient ranges from 10 to 30 feet below the 400 pressure zone hydraulic gradient which it serves, while the Baltimore water supply system gradient must be reduced through a pressure reducing valve before entering the 400 pressure zone. The 400 Zone is also supplied through pressure reducing valves from the 550 Zone which is in turn supplied from the Baltimore County water connections.

Future increases in demands in the 400 Zone and the 550 Zone will normally be supplied from the Baltimore City Central System. However, potential increases in available maximum day supply from WSSC would provide Howard County with the flexibility to supplement or partially replace supplies from the Baltimore Central System connections during emergencies and high demand periods. Provision of this flexibility is considered

to be in the best interests of Howard County since the County does not have direct control over its water supply sources.

3.6 Future Construction

The Baltimore City Central Water supply system and the Washington Suburban Sanitary Commission system have adequate transmission and supply capabilities to meet existing supply needs. However, in emergency or drought conditions, some user restrictions could be placed on Howard County by the suppliers.

The Baltimore Central System requires major new facilities to develop additional water supplies and to provide for the future water needs of Howard County. The facilities required within the Western Third Zone of the Central System are addressed in detail in the 2003 Baltimore Central System Report. Most of the facilities described in the Report have been constructed and placed in service.

The Central System Report states that the Western Third Zone presently has adequate storage and only 600,000 gallons of additional storage capacity will be necessary to meet year 2025 demands. The Zone currently has 37.4 MG of storage capacity located in three storage facilities (Catonsville Reservoir 1, Melvin Avenue Tank and the Pikesville Reservoir). Most of the storage is provided by Catonsville Reservoir 1, which was placed in service in 1995 and is located west of the intersection of U.S. Route 40 and Rolling Road in Catonsville. Catonsville Reservoir 1 was constructed as the first phase of a two-phase project with a capacity of 20 MG, of which approximately 10 MG of storage was allocated to Howard County. The second phase of the project was planned to provide an additional 32 MG of storage.

In lieu of constructing the proposed Catonsville Reservoir 2, the Central System Report suggested that the City consider taking advantage of the surplus supply capacity of the Ashburton and the Leakin Park Pumping Stations to satisfy future demand. When operating together, the capacity of the two stations exceeds the projected year 2025 maximum day demands of the Western Third Zone and dependent upper zones. The reliability of this suggestion was tested, however, in December 2010 when a pipe leak at the Leakin Park Pumping Station forced a shutdown of the station. City staff responded quickly to activate backup pumps at the Ashburton Pump Station to maintain water flow to the Catonsville Reservoir. The water supply to the Western Third Zone may have been significantly compromised if the station shutdown occurred under higher demand conditions.

Howard County anticipates entering into an inter-jurisdictional agreement with Baltimore City, Baltimore County, and Anne Arundel County to address construction of the required central system improvements. This agreement will specify construction schedules and jurisdictional cost shares. In addition, it will specify water demands and flow limitations for each participating jurisdiction. The facilities which are anticipated to benefit Howard County are individually discussed below.

Fullerton Filtration Plant - The filtration plant will treat water from the Susquehanna River, and must accomplish softening and corrosivity reduction in addition to the normal filtration processes. The facility will have a minimum capacity of 66 MGD. However, computer simulations indicate a more balanced operation of the system when operating the Fullerton Filtration Plant at a maximum day rate of 101 MGD. Further, a maximum day capacity of 120 MGD will be needed if the Montebello Filtration Plant is partially taken out of service for an extended repair. A final determination of the size of the Fullerton Plant has not yet been made.

The Fullerton Filtration Plant will provide water directly to the eastern side of the First Zone, thus reducing the demands on the Montebello Filtration Plant in this area. This plant will also supply the Fullerton Second and Eastern Third Zone Pump Stations via the Fullerton Reservoir. Potable water supplied by the plant will eliminate the need of expansion of the Ashburton Filtration Plant since a portion of the required Second Zone supply will be pumped from the First Zone.

Deer Creek Pump Station, Pumps Addition - The Deer Creek Pump Station is/will be used to pump raw water from the Susquehanna River through the Susquehanna Transmission Main to both the Fullerton and Montebello Filtration Plants. The existing Deer Creek Pump Station has three 50 MGD pumps installed. With one pump in reserve, the station has a safe capacity of 100 MGD. There is space available for adding additional pumps to the Deer Creek Pump Station which will provide a safe capacity of 250 MGD.

Given below is a listing of the various Central System improvements required and the approximate time frames as given in the 2003 Central System Report and later reports.

<u>PROJECT</u>	<u>Projected Completion Date</u>
1. Fullerton Reservoir	2015
2. Addition of Two 50 MGD Pumps at Deer Creek Pump Station	2015
3. Fullerton Filtration Plant	2015 (delayed by funding)

3.7 Groundwater Supply

Approximately 15 percent of the population of Howard County relies upon ground water for its water supply. Ground water is the major source of potable water where public water service is not available. Ground water from the crystalline rock formations will continue to be a major source of potable water in the western areas of Howard County, where new private individual wells will continue to be developed in the “No Planned Service” area. Howard County has no plans to allow the development of community wells.

Table 4 is an inventory of the existing well and surface water supplies in Howard County. The table was compiled from the list of active State Water Appropriation Permits that is maintained by the Maryland Department of the Environment.

Information about the ground water conditions in Howard County was obtained from the study “Water Resources of Howard County, Maryland” which was published by the Maryland Geological Survey in 1995, as Bulletin 38. That study was based on review of well records for over 2,000 wells, and chemical sampling and analysis of water from over 80 wells.

Bulletin 38 reported the State’s investigation of 2,354 crystalline-rock wells in Howard County. The reported well depths in their study ranged from 13 to 750 feet. In recent years it has become more common for residential and commercial crystalline-rock wells to be drilled deeper than 750 feet, in order to reach deeper water-bearing fractures and to increase the volume inside the well that can be used for water storage. The majority of these wells have a diameter of 6 inches. Some of the higher-yielding wells will have diameters of 8 inches.

Approximately 25.5 MGD of water was used in Howard County in 2013. Of this amount, 2.9 MGD was obtained from private ground water systems and from private surface water systems, and 22.6 MGD was delivered by two public water systems. The public water systems are the Baltimore City system and the Washington Suburban Sanitary Commission system.

Howard County has parts of two physiographic provinces within its boundaries. The Coastal Plain, which occupies the extreme eastern part of the County (10%), has gravel, sand, silt and clay which were deposited in layers upon the eastward-dipping surface of the bedrock. The Piedmont province, which is present in the other 90% of the County, is characterized by an undulating surface with ridges and narrow stream valleys, underlain by crystalline rocks. The Fall Zone forms a boundary area between the Piedmont and

Coastal Plain provinces. The Fall Zone trends in a northeast-southwest direction through Howard County, roughly parallel with I-95.

The geology of the County influences the ground water availability. Figure 2-2 in Chapter 2 is a generalized geologic map of Howard County which shows the geologic formations underlying the land surface. The Coastal Plain area in eastern Howard County is underlain by sediments of the Potomac Group. The remainder of the County is underlain by metamorphic and igneous rocks of the Piedmont. The Piedmont geology is complex, due to multiple episodes of folding, faulting, and intrusions by magma throughout geologic time.

In the Piedmont province, ground water is found in the joints and fractures of the igneous and metamorphic rocks. Higher-yielding wells tend to intersect a greater number of water-bearing fractures, and intersect more productive fractures. The layer of weathered rock and soil that rests on top of the bedrock is called saprolite. The saprolite functions as a reservoir that supplies water to the fractures in the bedrock.

Although the overwhelming majority of the wells in Howard County (98%) are in the Piedmont area, wells also exist which obtain water from the intergranular spaces of the sediments of the Coastal Plain. The Coastal Plain has unconsolidated layers of sediments belonging to the Cretaceous-age Patuxent Formation, and the Tertiary-Quaternary age terrace gravels, alluvium (stream deposits), and colluvium (slope deposits). In Howard County the maximum thickness of the Coastal Plain deposits is about 140 feet. In some areas the water-bearing sands are confined beneath impermeable clays, while in other areas unconfined, or water-table conditions exist.

The fractured-rock aquifers are generally more susceptible to contamination than the Coastal Plain aquifers, because contaminants are absorbed to a greater degree on unconsolidated sediments than on bedrock fractures. The fractured-rock aquifers are also more susceptible in areas where the soil and saprolite are thin, and rapid recharge to the aquifer occurs.

In the Cockeysville Marble, the natural process of rock dissolution produces solution channels and other openings in the bedrock, such as sinkholes. The dissolution is caused by the movement of acidic ground water through the marble, and it can lead to relatively faster travel times for contaminants through the aquifer.

The natural quality of the ground water in Howard County is generally good, with the exception that the water is somewhat acidic in most areas. Some results of acidic water may include corroded plumbing, stained laundry, and an unpleasant taste. Acidic water

may be addressed in residential water systems by addition of a substance to raise the pH of the water.

For wells completed in the Cockeysville Marble formation, the ground water may be naturally “hard” due to the presence of dissolved calcium and magnesium originating from the rock. Hard water may present difficulty in washing, or may cause mineral deposits in plumbing; it is typically addressed in residential supplies by a water softener system.

In Howard County, two naturally occurring radioactive elements in the ground water, radium and radon, have attracted attention. These elements emit a form of radiation known as alpha radiation. The U.S. Environmental Protection Agency (EPA) has indicated that some people who drink water containing alpha emitters in excess of EPA’s standard over many years may have an increased risk of getting cancer. EPA’s standards are not intended to regulate private wells, however they are provided here for reference.

Beginning in the early 2000’s, but notably around 2006, the Howard County Health Department (HD) began and has continued collecting well water samples for Gross Alpha, Gross Beta and Radium 226/228 from properties in and immediately around the Baltimore Gneiss geologic formation in Howard County. These naturally occurring radionuclides have been linked to this type of geology. The Maryland Geological Survey has identified this formation running in a north to south direction generally down the central part of the County. The Howard County Health Department initially concentrated its sampling efforts on existing properties, but over the past few years is more focused on new construction and pre-emptive identification of potentially impacted wells. The Environmental Protection Agency (EPA) has established a maximum contaminant level (MCL) of 15 picocuries per liter (pCi/L) for Gross Alpha and 5pCi/L for combined Radium 226/228. EPA has also established a target value of 50pCi/L for Gross Beta. As of early February 2015, the Health Department has tested approximately 1780 wells (totaling about 2245 samples) for these parameters. To date, data indicates that approximately 13% of wells tested, have exceeded a Gross Alpha and /or Gross Beta value. Approximately 2% have also shown an elevated combined Radium 226/228, which has known links to bone cancer. All newly constructed wells showing elevated levels are required to have appropriate treatment installed prior to occupancy, and are subject to signed “Treatment Agreements” by the owners and are recorded in the County Land Records. Up to date results of County testing are shown in **Figures 3-3 and 3-3A**.

Radon has also been detected in samples from wells completed in the Baltimore Gneiss in Howard County. The EPA proposed a water radon standard of 300 picoCuries per liter. In the above-referenced Maryland Geological Survey study of Howard County, the

dissolved radon concentrations of ground water ranged from 800 to 40,000 picoCuries per liter, with a median of 3,400 picoCuries per liter. Radon in air is more dangerous than radon in water, and there are no plans at present for remediation.

A ground water balance indicates that adequate ground water resources are available in the Piedmont area of Howard County for the current uses. The average annual hydrologic budget for the Piedmont part of Howard County is as follows: precipitation (42 inches) equals evapotranspiration (28 inches) plus overland runoff (5 inches) plus ground water runoff (9 inches). Part of the ground water runoff is used for water supply. In this analysis, the ground water part of the budget may be halved to 4.5 inches/year to conservatively represent drought conditions. (Palmer Drought Severity Index data maintained by the National Climatic Data Center indicates that “extreme” drought conditions occurred in central Maryland, in five different years during the 30-year period of 1976 to 2005.) The drought-year ground water recharge of 4.5 inches distributed over the 226-square mile Piedmont part of the County is equivalent to 48.4 MGD. The 1990 estimate of the combined private ground water and surface water withdrawals of 3.1 MGD represents 6 percent of the drought-year ground water recharge. This magnitude of ground water withdrawal is reasonable and sustainable.

The preceding ground water balance is regional, and site-specific characteristics such as the local geology, the extent of bedrock fractures, and localized ground water contamination will continue to influence how much ground water is available from a given property. The Howard County Health Department has indicated that several areas with ground water problems exist. **Table 7** is an inventory of these problem areas.

3.8 Other Supply

Surface waters are not available for development by Howard County as public water supply sources since the larger streams have already been developed by others to a high degree. The major surface waters in Howard County include the Patuxent River, the Little and Middle Patuxent Rivers, Dorsey Run, Deep Run and the Patapsco River.

Planning by WSSC suggests utilization of the Patuxent River to its fullest extent. Existing reservoirs are required to discharge sufficient flow to maintain downstream aquatic life in accordance with reservoir discharge permits issued by the Department of Natural Resources. In addition, the Patuxent River is used for the assimilation of sewage effluent from the Maryland City Sewage Treatment Plant in Anne Arundel County.

The Middle and Little Patuxent Rivers and tributaries thereto are utilized to a small extent by several manufacturers and institutions in Howard County. Fort Meade also withdraws

water from the Little Patuxent River downstream from the Howard County line. The Little-Middle Patuxent flows in Howard County are used for the assimilation of sewage effluent from the Little Patuxent Wastewater Treatment Plant which has a treatment capacity of 25.0 MGD. It is expected that the Little and Middle Patuxent Rivers and associated tributaries in Howard County will be developed to provide water for recreational purposes. The County has no plans to develop these sources as a potable water supply beyond the present limited industrial use. Three lakes have been constructed in Columbia, in the Little Patuxent Basin for recreational use. Although not designated for this purpose, these lakes also provide for stormwater management. **Table 5** lists existing impounded potable water supplies in Howard County.

Dorsey Run is used to assimilate effluent from the State's sewage treatment plant in Jessup. Due to its small size, and use by the State, Dorsey Run does not offer the potential to supply any significant quantity of water for potable or industrial use in Howard County.

The Patapsco River is the only water course which has a potential for contributing to the public water supply in Howard County. However, several factors limit the safe yield of the river: (1) natural flow alteration by the Liberty Reservoir; (2) withdrawals by numerous industries, institutions, and towns en route; and (3) deposition of sewage and waste by industries, institutions, and towns en route.

3.9 Water System Hydraulic Modeling

The water system has been modeled considering present and future demands to the year 2040. This includes areas of known development and areas of infill development through the year 2040. Areas with inadequate hydraulic capacity were identified and alternative solutions tested. Additionally, the water quality was modeled using water age analysis and solutions to high water ages were identified and tested. **Table 8**, Priorities for Water System Development, was revised in accordance with these analyses. The modeling effort is described below.

The County is utilizing H2O Map, a fully calibrated hydraulic distribution system modeling software, for all water system modeling. This software is comprised of approximately 13,500 nodes and 15,000 pipes, ranging in size from 8 to 48 inches. This program can be utilized for regular (steady-state) and extended period simulations. The extended period simulations are useful in studying system response to demands over time, such as an entire day or multiple days. Fluctuations in water tank levels caused by variation in water demand over the day are considered. Extended period simulations are also useful in analyzing water age in tanks and nodes in the system over time, as an

indication of water quality. Extended Period Simulations were performed using 24 hour periods or longer to ensure that system components are adequately sized to refill storage tank levels lowered during peak demands.

The County's water mapping system was used to develop the initial water model, along with the diameter and length of transmission mains, the elevation of junctions, elevated water tank characteristics (capacity, maximum and minimum water levels), and the pump curves for each water pump station obtained from record drawings and other sources. A countywide base model with the pressure zones connected via pumping stations and pressure reducing valves (PRV) was developed to simulate the water transmission as close as possible to the real scenario. Calibration of the model was performed by conducting various fire flow tests within the system at various demand conditions, and results were analyzed to ensure a match with actual conditions. The system information was input for each water pressure zone and used as part of the model database, and a skeletonization program was used to consolidate redundant piping systems and eliminate insignificant pipes. Accordingly, the output report for each zone can be extracted and summarized individually for further analyses.

The County maintains a record of recent development and improvements to the water system using the County's GIS system. The piping network in the initial water model was updated using the County's GIS system to represent the current Howard County water network.

The Department of Planning and Zoning provided geocoded population projections, which located projected populations and commercial/industrial acreage to be served by the public water system for the years 2015, 2020, 2025, 2030, 2035 and 2040. This population data was incorporated in the computer model data base using determined demand factors.

Demand factors (per capita use, etc.) used in the model are determined from existing Howard County metered water purchase data and metered water usage data. Individual factors were determined for Residential, Commercial, and Industrial flows and applied to the model using the Department of Planning and Zoning's projections. Projected water usage due to Commercial Redevelopment data provided by the Department of Planning and Zoning was developed using projection factors from the 2012 MDE Design Guidelines for Sewerage Facilities. To better model the daily flow pattern, a diurnal curve was developed based on flow data and applied to all demand nodes. A peaking factor of 1.5 was applied to all time steps to determine maximum day use based on 10 years of historical data provided by the County which showed peaking factors ranging from 1.16 to 1.48.

Zones were also modeled with maximum day demands plus simultaneous fire demands. The fire demands were assumed to be located in the portion of each zone which has the lowest operating pressure for maximum day demand. Other locations were selected for fire flow simulations based on size of supply main, ground elevation, system looping, etc. This analysis identified areas lacking adequate water pressure to fight fires. For detached housing in residential areas, the water demand for fire-fighting was assumed to be 750 gallons per minute (GPM), while for commercial/industrial and multi-family housing areas, the water demand for fire-fighting was assumed to be 1,500 GPM as specified in the Howard County Design Manual. Areas with inadequate pressures were determined and corrective measures selected.

As an input to the H2O Map software for sizing pump stations, pump curves are utilized to allow analysis of system operating pressures. For future pumping stations, actual rating curves are not available. However, for modeling purposes, estimated pumping curves were selected from information provided by pump manufacturers. Estimated pump curves were used since they provide a more accurate simulation of pump station operation than do theoretical horsepower ratings. The actual curve of the pump station, when built, may be different from the estimated curve and will be determined at the actual time of pump station design.

The hydraulic water model was also used to analyze the predicted water age in the system, as an indicator of potential water quality problems. Water age was evaluated using extended period simulations, under average day demands, and was evaluated at system nodes and tanks.

The flow projections given in Tables 3, 3A, and 3B are for the twenty-five year planning period. This period is selected for analysis in the Master Plan since twenty-five year development and population projections are prepared by the Department of Planning and Zoning. The results of the hydraulic analysis served as a basis for identifying projects to be included in Table 8.

Table 6A lists public water storage tanks, both existing and proposed, which are part of the Howard County public system. **Table 6B** lists existing and proposed public system water pump stations. Table 8 provides a complete listing of proposed water facilities projects in the 0 to 5 year, 6 to 10 year, and Comprehensive Plan categories. The existing and proposed water facilities are shown on the attached **Figure 3-4: Immediate, 5-Year, 10-Year and Comprehensive Priorities Map for Water System Development**.

It is noted that the pipe sizes given in Table 8 and on the WATER FACILITIES PLAN MAP for proposed projects are for ultimate development since the design life of transmission mains exceeds 25 years. Ultimate flow projections are based on existing development patterns and densities and on the allocated capacity of undeveloped land as provided by the Department of Planning and Zoning. It is often advantageous from an engineering or economic perspective to initially size and construct conveyance facilities based on the ultimate development potential of the area served. In determining whether or not a facility should be initially constructed to meet twenty-five year (build-out demands), the following must be addressed in an engineering analysis of the proposed project:

1. Present worth analysis, comparing the cost of phased implementation (construction of parallel mains, incremental pump station expansion, etc.) with the cost of a facility initially providing capacity for ultimate development.
2. System hydraulics, considering such factors as differences in pump or pipe sizes required for twenty-five year and ultimate flows, head losses, retention time, etc.
3. System reliability, considering the advisability of having parallel facilities to provide for limited flow capacity during maintenance or repair periods.
4. Construction limitations, considering the difficulties involved with constructing parallel facilities after initial construction is complete.
5. System design life, considering the useful life of the facility.

3.10 Required Local System Improvements

A. 300 Pressure Zone

Analysis of the 300 water pressure zone (lower Elkridge and vicinity) shows that no further expansion will be required during the length of the planning period (2040).

B. 350 Pressure Zone

The analysis of the 350 water pressure zone (Ellicott City and immediate surroundings) showed that no further system expansion will be required through the year 2040.

C. 400 Pressure Zone

A new 2.0 MG EST, the Guilford Tank (W8262), is planned for the 400 Zone. The existing ground level Guilford Tank, currently out of service, will be converted to a reclaimed water tank (see Chapter 4). The new elevated tank is currently in the planning process, and was evaluated for inclusion in the Year 2020 time step of the model. The new tank will be used in conjunction with the existing GBFM tank (0.75 MG) to provide storage capacity and redundancy for the 400 Zone in the future. With the addition of the new Guilford Tank, PRV controls will need to be updated to coordinate with levels in the new tank.

High velocities (above 6 ft/s) are projected to occur in the existing 12-inch diameter cast iron water main located at the north end of the 400 zone that supplies water from the Gun Road supply through the Patapsco Valley State Park to Levering Avenue in Elkridge. By Year 2016, a new section of 12-inch and 16-inch water main (approx. 6,600 lf) from Edgewood Road in Patapsco State Park in Baltimore County to Levering Avenue in Howard County to US Route 1 will increase the reliability of the water supply to the 400 Zone and decrease velocities in the supply line (W8300). This project is currently under construction.

The existing Whiskey Bottom Road water pumping station contains one booster pump and a pressure reducing valve (PRV). The PRV supplies water from the southern portion of the 550 zone into the 400 zone. The booster pump remains in service for standby purposes to provide the ability to supply water from the 400 Zone to the 550 Zone, if needed. A new project, Capital Project W8320, is under way to relocate the existing Whiskey Bottom pump station and PRV. The purpose of this project is to re-structure the existing water distribution to accommodate the expansion of residential and commercial development in the Whiskey Bottom Road area. At completion, the County will have increased flexibility to move water between the 400 and 550 Zones more freely in this area.

There are several areas in the 400-pressure zone that have experienced low pressures (below 40 psi) due to their relatively high elevations. Low pressures were observed near the Whiskey Bottom Pump Station (and PRV) and Gorman Road PRV. When the County experiences low pressures in these areas, the Whiskey Bottom PRV and Gorman Road PRV are manually opened to increase pressure locally above 40 psi.

Additional improvements were identified in the 400-pressure zone to serve new areas of development, or to provide additional system looping. These improvements are as follows:

1. By Year 2015, the installation of approximately 5,500 linear feet of 12-inch water main along Dorsey Run Road (W8292).
2. For Year 2020, the installation of approximately 1,000 linear feet of 12-inch diameter water main along Anderson Avenue in the Harwood Park area will be needed to complete the replacement and enlargement of the Contract 2-W water main from Loudon Avenue to Hanover Road (Capital Project no. W-8303).

D. 550 Pressure Zone

An analysis of the 550-water pressure zone identified problems in meeting future demands if no further system improvements are made. These problems include areas of inadequate pressures and high pipe velocities.

A series of improvements are recommended in the 550 Zone to increase the north to south flow of water in the zone. The addition of these projects alleviates a majority of the problems in the 550 Zone. Phasing of these improvements is as follows:

1. The installation of an 18,000 linear feet of 36-inch water main along Route 29 between Route 108 and Broken Land Parkway to parallel existing mains is recommended (W8296). Construction of this water main is currently in progress.
2. For Year 2016, the installation of a 4,100 linear feet of 30-inch water main along Broken Land Parkway from Steven Forest Road to Cradlerock Way is recommended (W8307).
3. For Year 2030, the installation of 14,000 linear feet of 24-inch water main to parallel existing water mains along Route 29 from Route 32 to Route 216 is recommended (W8308).

As an alternative to some of the recommended piping improvements, it was observed using the model that additional water may be available to southern portions of the 550 Zone by adjusting operations of the Whiskey Bottom pumping station and PRV. Currently the Whiskey Bottom PRV is in service to supplement the 400 Zone supply; while the pumping station is under standby. The Whiskey Bottom pumping station could be used to provide flow to the 550 Zone from the 400 Zone, especially after the construction of the new Guilford Tank provides additional storage to the 400 Zone.

Design is in progress to relocate the Whiskey Bottom pumping station and PRV and upgrade the station pumping capabilities (Capital Project no. W-8320).

The zone analysis also showed that the existing water storage capacity provided in the Snowden River and Scaggsville tanks will be sufficient to meet the zone's demands beyond 2040.

E. 560 Pressure Zone

The analysis indicates that no further expansion of the 560 zone (Hollifield area) will be required during the planning period (2040).

F. 630 East Pressure Zone

An analysis of the 630 East Zone showed the existing distribution system and storage available to be adequate through year 2040. This Zone is supplied from the 550 Zone with water pumped through the Edgar Road and Montgomery Road pump stations. The stations are capable of supplying average day demands to the zone. The existing storage at the Oakland Ridge and Jonestown tanks was shown to be adequate through 2040.

Low pressures and available fire flows were observed in the eastern portion of the 630 East zone off of Illchester Road. The area in question is served by a single 8-inch water main along Illchester Road, which serves as a bottleneck. In Year 2016, the service to the area will be increased to a 12-inch line to provide adequate flow and pressure to the area. By making these improvements, pressures and available fire flow issues will be resolved.

G. 630 West Pressure Zone

In previous amendments to the Water & Sewer Master Plan, growth projections for the 630 West water pressure zone indicated that main extensions, storage, and pumping facilities were needed to serve new development. In order to provide adequate water pressure to areas west of Turf Valley Road during peak demand periods, a 20-inch main was constructed in 1990 along US Route 40 from Dogwood Lane to Bethany Lane where it connected with the 630 West Zone distribution system. This main serves as the suction and discharge main for the Pine Orchard pumping station. Upgrades to the Pine Orchard pumping station were completed in 2014 to increase the station capacity from 3.7 MGD to 5.2 MGD.

The current hydraulic analysis shows that the Harpers Choice Tank cycles regularly through year 2040. Expansion of the Columbia Pumping Station pump capacity is not shown to be needed.

Previously, storage capacity in this zone was considered deficient based on Howard County design criteria. The Marriottsville EWT, located off Marriottsville Road on property of the Alpha Ridge landfill, was constructed and placed into service in 2014 with capacity of 1.25 Million Gallons (MG) to mitigate the storage shortage.

In an effort to increase redundancy and improve the reliability of water supplied to the portion of the 630 West Zone south of Maryland Route 108 and west of US Route 29, the Department of Public Works commissioned an evaluation and study of water supply and storage alternatives for the area that includes central Columbia and Clarksville. The study recommended construction of a new water pumping station in the southern portion of the 630 West Zone to provide a second pump feed to supplement the Columbia Pumping Station. Capital Project W-8328 was created for design and construction of the new 630 West water pumping station.

As described in Chapter 1, the Planned Service Area was expanded to include approximately 221.1 acres of the historic Doughoregan property (refer to EXHIBIT 1, revision W-01) and four properties comprising 90.33 acres in the Clarksville area (refer to EXHIBIT 1, revision W-02) within the 630 West water zone. The water demand projections for these areas are included in Tables 1 and 1A of Chapter 2. Based on current zoning densities and water demand projections, hydraulic analysis shows that the major water facilities (transmission mains 12-inch diameter and larger, pumping stations and water storage) are adequate for the increased demand through the planning period.

1. Water service to the expanded service area of the Doughoregan property (Westmount subdivision) is available from the US Route 40 West 16-inch diameter water main constructed under County contract 1446, and the Centennial Lane 12-inch diameter water main constructed under various County contracts.
2. Water service to the expanded service area in the Clarksville/Guilford Road area is available from the Guilford Road 12-inch diameter water main constructed under County contract 3299.
3. The capacity of local water distribution facilities and necessary improvements will require evaluation as development plans are prepared.

H. 630 South Pressure Zone

Analysis shows that the Fulton Tank and associated pump stations will supply appropriate pressures and fire flow through full build-out of this zone in 2040. New development projects will continue in the 630 South Zone through Year 2025, including approximately 28,000 linear feet of 12” water distribution main to complete looping. The zone analysis also showed that the water storage capacity provided by the Fulton Tank will be sufficient to meet the zone's demands beyond 2040.

As described in Chapter 1, the Planned Service Area was expanded under PlanHoward 2030 to include approximately 91.25 acres of land in the Fulton area (refer to EXHIBIT 1, revision W-03) within the 630 South Water Zone. The water demand projections for this area are included in Tables 1 and 1A of Chapter 2. Based on current zoning densities and water demand projections, hydraulic analysis shows that the major water facilities (transmission mains 12-inch diameter and larger, pumping stations and water storage) are adequate for the increased demand through the planning period.

Water service to the expanded service area is available from the Scaggsville Road 16-inch diameter water main constructed under County contract 3505. The capacity of local water distribution facilities and necessary improvements will require evaluation as development plans are prepared.

I. 730 Pressure Zone

The Waverly Woods subdivision in western Ellicott City was initially planned to be served within the 630 West Zone. However, the westernmost portion of the Waverly Woods subdivision from Dorchester Way to Marriottsville Road was converted from the 630 West to the 730 Zone in the mid-2000s due to changes in residential fire protection sprinkler requirements. The demand added to the 730 Zone water system required additional pumping capacity at the Frederick Road water pumping station. To meet this demand, the upgrade and expansion of the Frederick Road WPS from capacity of 0.58 MGD to 1.6 MGD was completed in 2012.

A new pumping station was constructed in the base of the new 630 West Marriottsville EWT tank to provide a redundant water supply for the 730 Zone. The Marriottsville Road water pumping station can supply up to 3.2 MGD to the 730 Zone under peak flow conditions as backup to the Frederick Road WPS. Construction of the tank and the Marriottsville Road pumping station were completed in 2014.

The zone analysis showed an area of reduced pressure (below 40 psi) along Mount View Road due to the relatively high elevations; however it adequately meets County standards. The Marriottsville Tank and the Alpha Ridge Tank and associated pump stations will be able to supply appropriate pressures and fire flow through full build-out in 2040.

3.11 Water Quality Modeling

The H2O Map hydraulic water model was used to model water age throughout the Howard County system. Water age analysis is often used as an indication of water quality, as long system retention times can lead to the deterioration of quality. Problems associated with longer system retention times include the formation of disinfection byproducts, decay of disinfectants, and poor color, taste and odor. The American Water Works Research Foundation (AWWARF) recommends water age under 2.5 days in system tanks, which equates to an approximately 40% turnover rate per day. However, water age may not accurately predict poor water quality in every water system. In addition to modeling, Howard County has commissioned several rounds of biological testing and sampling to test system wide water quality.

Modeling analyses were conducted through Year 2040 using Average Day Demand Extended Period Simulations to test water age at demand nodes and tanks. All required local system improvements were included in the appropriate modeling years. Since Howard County receives all of its system water supply from surrounding areas, each supply point has an initial water age. The water age for the main supply points (Elkridge, Route 40, Gun Road and WSSC) are 60 hrs, 37 hrs, 75 hrs and 24 hrs respectively. Water age results by zone from the hydraulic model are as follows:

A. 350 Pressure Zone

Analysis of water age in the 350 water pressure zone shows that water age ranges from 2.5 days to 7.5 days except for nodes at the end of lines which experience greater water age due to the lack of circulation. Water age does not greatly differ between time steps in the model. This zone does not contain a water storage tank, therefore; water age is dictated mainly by the retention of water within the water mains that supply this area.

B. 400 Pressure Zone

According to modeling results, water age is lowest (less than 2.5 days) at the southern end of the zone due to WSSC having the lowest initial water age. As the demand in the zone increases through build out in 2040, water age slightly worsens in the southern end

of zone with a portion having a water age between 2.5 and 7.5 days. Maximizing the supply of water from the WSSC system to the southern portion of the 400 Zone should help reduce the water age in the 400 Zone.

Improvement in water age in the 400 Zone can be achieved when the Zone's two tanks are cycled more deeply by adjusting PRV and pump controls. Water system operations can be managed to provide deeper tank cycling to reduce the water age but must be balanced with the need to maintain a sufficient volume of water for equalization, firefighting and water supply emergencies.

C. 550 Pressure Zone

Modeling results indicate that water age throughout the majority of the zone remains under 2.5 days through 2040. Water age increases towards the southern end and the outer extremities of the 550 Zone away from the central supply line. In the area of the Scaggsville Tank at the southern end of the 550 Zone, water age is between 2.5 to 7.5 days. Increases in age in the Snowden River and Scaggsville Tanks remain linear through year 2040. Water system operations can be managed to provide deeper tank cycling to reduce high water age but deeper cycling must be balanced with the need to maintain a sufficient volume of water for equalization, firefighting and water supply emergencies.

D. 630 East Pressure one

Modeling efforts show that the majority of water age in this zone ranges between 2.5 to 7.5 days through full build-out (2040) with minimal improvement in the northern end of zone. Water age at nodes does not greatly differ between time steps. Both the Jonestown EWT and Oakland Ridge EWT have water ages greater than 2.5 days. As demand in the Zone increases through year 2040, water age in these tanks decreases slightly due to greater tank cycling. Water system operations can be managed to provide deeper tank cycling to reduce the high water age but deeper cycling must be balanced with the need to maintain a sufficient volume of water for equalization, firefighting and water supply emergencies.

E. 630 West Pressure Zone

Analysis of water age in the 630 West Zone indicates that water age is greatest in the western portions of the zone with the majority of the zone between 2.5 to 7.5 days. The addition of the Marriottsville tank and the east-west piping increased water supply to this area and decreased water age in the northern portion of the zone. Both the Marriottsville

and Bethany tanks have water ages higher than 2.5 days. The greatest improvement to water age in this section occurs when cycling in the two tanks increases. Water system operations can be managed to provide deeper tank cycling to reduce the high water age but must be balanced with the need to maintain a sufficient volume of water for equalization, firefighting and water supply emergencies.

In the southwest section of the 630 West Zone, analysis shows that the majority of water age is above 2.5 days. Modeling results show that the addition of piping along Guilford Road to increase system looping and water movement does not significantly impact water age. Water system operations can be managed to provide deeper cycling in the Harper Choice tank to reduce the high water age but deeper cycling must be balanced with the need to maintain a sufficient volume of water for equalization, firefighting and water supply emergencies.

F. 630 South Pressure Zone

Modeling shows that the water age in the 630 South Zone and in the Fulton Tank is between 7.5 to 10 days. The results indicate that additional pipe looping within the zone does not significantly impact water age. Currently, the 630 South Zone is supplied water by two pump stations that pull from the southern portion of the 550 Zone. Therefore, water age in this zone depends on the water age in the southern portion of the 550 Zone, which is between 2.5 to 7.5 days. Improvements in the 550 Zone cause a slight reduction in the water age in the 630 South Zone to between 2.5 to 7.5 days but the water age still remains above 2.5 days through the year 2040. Water system operations can be managed to provide deeper cycling in the Fulton tank to reduce high water age but deeper cycling must be balanced with the need to maintain a sufficient volume of stored water for equalization, firefighting and water supply emergencies.

G. 730 Pressure Zone

Initial modeling results for Year 2015 show that the water age in this zone is greater than 2.5 days throughout, with the oldest water occurring in the western-most portion of the zone being between 7.5 to 10 days. The model results show that the water age remains greater than 2.5 days with a maximum water age of 10 days in the western portion of zone through full build-out in Year 2040. The high water age in the Alpha Ridge area is primarily due to the length of distribution pipeline installed to provide service to the low density residential area. Water system operations can be managed to provide deeper cycling in the Alpha Ridge tank to provide minor reduction of the water age but deeper cycling must be balanced with the need to maintain a sufficient volume of water for equalization, firefighting and water supply emergencies.

H. Summary

Overall modeling results indicate that the water age in the majority of the existing system is greater than 2.5 days. The water age is lowest at the US 40 supply towards the north end of the system, along the north-south water mains running the length of Route 29, and at the WSSC supply in the southern part of the 400 zone; age in these areas runs from 0 to 2.5 days.

The zones that experience the longest system retention times are the 630 South Zone and the 730 Zone. While water age decreases in the 630 South Zone through Year 2040, the model shows that it remains between 2.5 to 7.5 days. The water age in the 730 Zone slightly decreases but remains with a maximum water age of 10 days in the western portion of zone.

Additional pipe looping to increase the movement of water was tested but modeling shows it does not significantly impact water age in the system. The greatest decrease in overall system water age occurred with increased tank cycling. Water system operations can be managed to achieve deeper cycling in the water tanks to reduce high water age but deeper cycling must be balanced with the need to maintain a sufficient volume of water in each zone for equalization, firefighting and water supply emergencies.

3.12 Water Sampling Results

The water system hydraulic model showed the potential for high water age in many areas of the Howard County system, specifically in the 730 and 630 South pressure zones. High water age *can* be an indicator of water quality problems, but sampling is needed to confirm problems.

The County started a water testing program in 2008 to test for disinfection by-products (DBPs) and high chlorine residuals. Sampling was completed at multiple test locations throughout the system in areas that experienced longer retention times. The sampling efforts have shown acceptable levels of DBPs and chlorine residuals in these areas. The County maintains a regular sampling program and has not reported any problems to date. A summary of the sampling results are included as EXHIBIT 5.

3.13 Financing Water Improvements

The Department of Public Works assumed the function and duties of the Howard County Metropolitan Commission when the Charter form of government was established. Under the Charter and existing local public laws, the following charges are authorized to finance the construction, operation, maintenance and administration of water facilities:

1. Ad Valorem Assessment
2. Front Foot Benefit Assessment
3. Water House Connection Fees
4. Water User Charges
5. In-Aid-of-Construction Charges
6. Other Sources of Water System Funds

A. Ad Valorem Assessment

A yearly levy of \$0.08 per \$100 of assessed property value is currently made against all properties within the Metropolitan District. The assessment is a source of revenue designated to cover the cost of retiring bonds issued by the County and can be used to cover the payment of salaries and other expenses of the Department of Public Works related to the water and sewerage systems.

B. Front Foot Benefit Assessment

The front foot benefit assessment is levied against all properties provided with water service and the revenue is used for bond debt service. The current residential front foot assessment rate for fiscal year FY2015 is \$ 0.81 per foot for the first 150 feet, \$ 0.61 per foot for the second 150 feet, and \$ 0.30 per foot for all frontage over 300 feet. The commercial front foot assessment rate for water service is \$ 1.01 per foot of total frontage. Front Foot Benefit Assessment fees are no longer collected to recover costs for capital projects after FY2005.

Fixed frontages are as follows: 25 feet per unit for apartments, 45 feet per unit for mobile homes, and 12.5 feet per unit for motels.

C. Water House Connection Fees

After June 30, 2007, individual residential connections to the public water system shall be performed by Howard County licensed on-site utility contractors under contract with

the property owner. The County charges a \$300 inspection and administration fee and holds a 10% retainer based on the estimated construction cost.

Under special circumstances as approved by the Director of Public Works, a one-time charge may be used for connections to the public water system that are constructed by Howard County capital projects. This charge covers the construction of the connection from the water main in the public right-of-way to the abutting property line of the property served. Under these special circumstances, an individual homeowner is charged \$2400 for a standard 1½-inch water service connection with a 1-inch meter. Connections larger than 1½-inches and commercial connections will continue to be performed by the Advanced Deposit Order (ADO) process.

D. Water Service Charges

Water to the user is metered and paid under the prevailing schedule of charges. The rate consists of a two part charge; one being a volumetric charge based on a winter / summer usage differential, the other being a quarterly account user charge based on meter size. The current charges are as follows:

1. Quarterly Account User Charges (as of July 1, 2014):

<u>Meter Size</u>	<u>Charge</u>
5/8"-1"	\$ 14.57
1 ½"-3"	\$ 47.03
4"- up	\$ 239.20

2. Volumetric Rates:

Winter rate -	\$1.93/ 100 cubic ft.
Summer rate -	\$2.15/ 100 cubic ft.

E. Water In-Aid-of-Construction Charge (IACC)

This fee is applicable to all users of the water system and is a source of revenue designated to cover the cost to Howard County of construction or purchase of public water facilities, which serve or will serve all properties connected to the system, whether or not these facilities are located in the County. The fee structure was modified for Fiscal Year 2012, and is now a one-time charge based on the size of the water meter, with additional fees collected if a change in meter change size is required. The current FY2015 fee structure is as follows:

<u>Size of Water Meter</u>	<u>IACC Fee</u>	<u>Size of Water Meter</u>	<u>IACC Fee</u>
5/8 – 1” meters	\$ 600	6” meter	\$ 64,800
1 ½” meter	\$ 4,800	8” meter	\$230,400
2” meter	\$ 7,680	10” meter	\$336,000
3” meter	\$ 16,800	12” meter	\$422,400
4” meter	\$ 28,800		

The above charges, fees, and assessments are reviewed and readopted annually by the County Council with appropriate changes.

F. Other Sources of Water System Funds

In addition to fees and charges paid by property owners as a source of construction revenue, the County has the following sources of funds:

1. Developer Agreements - A Developer Agreement is the method of financing the construction of water distribution mains in a new subdivision. The developer advances the total construction cost of the mains including engineering and administrative expenses. The developer may recover his construction cost through the price of the lots or by creation of a private water company (under Maryland State law) to bill the cost through the users.
2. Interest Income - proceeds from bonds and revenues earmarked for construction are invested and earn interest until they are needed. Due to the irregularity of disbursements /and receipts, the annual interest income varies considerably.

CHAPTER 3

TABLES AND FIGURES

**PROJECTED WATER DEMANDS AND PLANNED CAPACITY
HOWARD COUNTY PUBLIC WATER SYSTEM**

Year	Household Population & Projected Water Demands					Baltimore City Contracted Supply			WSSC Supply	Total supply
	Total	Unserved	% served	Served	Average Daily Use (mgd) (2)	Gun Road	US Rt 40 (3)	Elkridge	All Saints (4)	
2013 ¹	--		--	261,789	----	1.0	28.7	8.8	3.0	41.5
2015	306,606	42,376	86%	264,230	25.0	1.0	28.7	8.8	3.0	41.5
2020	329,801	43,643	87%	286,158	26.9	1.0	28.7	8.8	3.0	41.5
2025	344,049	44,721	87%	299,328	28.3	1.0	28.7	8.8	3.0	41.5
2030	354,631	46,218	87%	308,413	29.3	1.0	28.7	8.8	3.0	41.5
2035	361,035	47,700	87%	313,335	29.9	1.0	28.7	8.8	3.0	41.5
2040	363,891	49,188	86%	314,703	30.3	1.0	28.7	8.8	3.0	41.5

Notes:

- (1) Unit demand flows developed for 2013 were not applied to previous years. Population and acreage shown are 8A values for 2013.
- (2) Average Day use including residential, commercial/industrial and redevelopment from Table 3A.
- (3) Supply established by July 1986 Agreement.
- (4) By 1988 Agreement, 3.0 ADF, 5.0 MDF

AVERAGE DAILY WATER DEMAND PROJECTIONS

	2013 ¹	2015	2020	2025	2030	2035	2040
Residential Use							
Population Served	261,789	264,230	286,158	299,328	308,413	313,335	314,703
Average Daily Demand (mgd)	17.3	17.4	18.9	19.8	20.4	20.7	20.8
Commercial Use							
Acreage served	4,108	4,425	4,694	4,825	4,961	4,961	5,009
Average Daily Use(2)	4.7	5.0	5.3	5.5	5.6	5.6	5.7
Industrial Use							
Acreage served	3,403	3,535	3,716	3,845	4,020	4,139	4,273
Average Daily Use(3)	2.4	2.5	2.6	2.7	2.8	2.9	3.0
Redevelopment Use							
Retail Area served (gsf)		39,640	218,264	534,622	841,567	1,260,846	1,638,010
Office Area Served (gsf)		333,318	961,528	2,736,706	3,690,876	5,346,886	7,061,418
Average Daily Demand (mgd) (4)	----	0.04	0.12	0.33	0.46	0.66	0.87
TOTAL							
	24.3	25.0	26.9	28.3	29.3	29.9	30.3

Notes:

- (1) Unit demand flows developed for 2013 were not applied to previous years. Population and acreage shown are 8A values for 2013.
- (2) Based on 2013 estimated unit demand values (Commercial - 1138 gpd/acre)
- (3) Based on 2013 estimated unit demand values (Industrial - 699 gpd/acre)
- (4) Based on MDE Sewerage design standards (Retail - 0.05 gpd/gsf, Office - 0.09 gpd/gsf)

TABLE 3B
AVERAGE DAY DEMAND AND
CONTRACTED WATER SUPPLY PROJECTIONS

Connection	Agreement	Current Contracted Supply Capacity	Projected Water Supply at Points of Connection (MGD) ⁽¹⁾						
			(MGD)	2015	2020	2025	2030	2035	2040
Baltimore City									
Gun Road	1934 Agreement	1.0	1.4	1.8	1.9	1.9	1.9	2.0	
U.S. Rt 40	Third Zone Agreement	28.7	17.6	19.0	20.2	21.1	21.6	21.8	
Elkridge	Second Zone Agreement	8.8	3.0	3.1	3.2	3.3	3.4	3.5	
WSSC									
All Saints	1988 Agreement	3.0	3.0	3.0	3.0	3.0	3.0	3.0	
TOTAL			41.5	25.0	26.9	28.3	29.3	29.9	30.3

Notes:

(1) For Years 2015 through 2040, the projected demands are based on average day supply rates as determined by the hydraulic model and planned system operations.

TABLE 4
INVENTORY OF EXISTING MULTI-USE COMMUNITY WELL AND SURFACE WATER SUPPLY

Water Appropriation Permit Number and Revision	Owner	Effective Year	Aquifer	Remarks	Average Limit (gal./day)	Maximum Month Limit (gal./day)	North Coord.	East Coord.
HO1950G001(07)	WILLIAMS TRANSCO PIPELINE	2006	LOWER PELITIC SCHIST WISSAHICKON	COMPRESSOR STATION 190 - ELLICOT CITY	500	1,000	522	820
HO1955G001(07)	W. R. GRACE & CO.	2006	LOWER PELITIC SCHIST WISSAHICKON	WASHINGTON RESEARCH CENTER	70,000	140,000	495	827
HO1958G001(05)	KONTERA LIMITED PARTNERSHIP	2005	PATUXENT FORMATION	LAUREL SAND & GRAVEL PLANT	500	1,000	496	881
HO1958G006(05)	MANGIONE ENTERPRISES OF TURF VALLEY	2013	COCKEYSVILLE MARBLE	TURF VALLEY GOLF COURSE	2,000	5,000	533	832
HO1961G004(04)	BOARMAN, FLORENTINE J.	1998	BALTIMORE GNEISS	BOARMAN'S MARKET	500	600	490	811
HO1962G005(05)	MARYLAND STATE HIGHWAY ADMIN	2007	LOWER PELITIC SCHIST WISSAHICKON	SHA GARAGE AT DAYTON	1,600	2,700	516	806
HO1963G006(04)	CONVENTUAL FRANCISCAN FRIARS	2001	LOWER PELITIC SCHIST WISSAHICKON	FRANCISCAN FRIAR RESIDENCE	1,500	2,300	518	817
HO1963G008(06)	SISTERS OF BON SECOURS USA	2010	SWIFT RUN FORMATION	RETREAT HOUSE & CONVENT	17,000	22,000	545	830
HO1965G003(02)	RONO RURAL ENTERPRISES, INC.	2002	LOWER PELITIC SCHIST WISSAHICKON	DRIVING RANGE	500	20,000	475	826
HO1966G006(04)	MT. AIRY HOWARD CHAPEL CHURCH,	1998	IJAMSVILLE FORM.-MARBURG SCHIST	CHURCH	100	500	540	755
HO1967G001(05)	HOWARD COUNTY PUBLIC SCHOOLS	2005	BOULDER GNEISS WISSAHICKON FORM.	GLENWOOD M. S.	5,000	7,000	532	792
HO1967G010(04)	NERI, LUIGI, AND ANNA	1998	PATUXENT FORMATION	ANNAPOLIS JUNCTION POST OFFICE	500	600	472	858
HO1968G001(04)	BROWN'S CHAPEL, UNITED METHODIST	2001	LOWER PELITIC SCHIST WISSAHICKON	BROWNS CHAPEL, UMC	100	200	512	802
HO1969G002(06)	A.J.R. PROPERTIES, LLC.	2010	PATUXENT FORMATION	MANUFACTURE CINDER BLOCKS	700	900	471	859
HO1971G006(02)	EXXON MOBIL CORPORATION	2001	BALTIMORE GNEISS	EXXON STATION NO 27459	500	800	500	816
HO1972G002(04)	DAYTON ROD AND GUN CLUB, INC.	2004	LOWER PELITIC SCHIST WISSAHICKON	CLUB	100	200	509	801
HO1973G003(04)	HOWARD COUNTY PUBLIC SCHOOLS	2003	BOULDER GNEISS WISSAHICKON FORM.	GLENELG H. S.	7,100	10,300	525	799
HO1973G004(05)	HOWARD COUNTY PUBLIC SCHOOLS	2005	WISSAHICKON FORMATION	LISBON E. S.	2,500	3,000	547	780
HO1973G006(04)	HOWARD COUNTY PUBLIC SCHOOLS	2005	LOWER PELITIC SCHIST WISSAHICKON	WEST FRIENDSHIP E. S.	1,500	2,000	535	815
HO1973G011(04)	FAITH COMMUNITY CHURCH	2005	IJAMSVILLE FORM.-MARBURG SCHIST	CHURCH	300	500	549	758
HO1974G001(03)	LIBERTY BAPTIST CHURCH	2002	WISSAHICKON FORMATION	CHURCH	100	300	548	780
HO1974G002(04)	FERGUSON, SR, JAMES, R.	2006	WISSAHICKON FORMATION	SAND & GRAVEL HAULING	250	500	543	791
HO1975G003(04)	THE ROMAN CATHOLIC ARCHBISHOP	2003	METAGABBRO AND AMPHIBOLITE	CHURCH HALL	800	1,000	548	770
HO1975G009(05)	GLENELG COUNTRY SCHOOL	2008	SETTERS FORMATION	SCHOOL POTABLE, COOLING, IRRIGATION	8,000	12,000	517	811
HO1976G001(03)	HOWARD CO DEPT RECREATION	1998	LOWER PELITIC SCHIST WISSAHICKON	CENTENNIAL PARK	1,000	2,500	513	839
HO1978G005(03)	INTERMEDIA COMMUNICATIONS, INC.	2002	WISSAHICKON FORMATION	TOWER AND MAINT FACILITY UNMANNED	100	100	541	792
HO1979G005(05)	MOUNT AIRY BIBLE CHURCH	2005	WISSAHICKON FORMATION	CHURCH & SCHOOL	2,000	4,000	552	772
HO1981G003(04)	LISBON UNITED METHODIST CHURCH	2013	WISSAHICKON FORMATION	CHURCH/DAY CARE	500	800	546	781
HO1981G004(03)	ARMSTRONG, WILLIAM	2004	LOWER PELITIC SCHIST WISSAHICKON	GWHP	3,000	6,000	504	800
HO1981G006(03)	GLYNN, JAMES C.	2004	BALTIMORE GNEISS	SMALL BUSINESS OFFICE	100	200	490	812
HO1981G007(03)	J.R. ENTERPRISES	2003	LOWER PELITIC SCHIST WISSAHICKON	EYRE BUS SERVICE	2,000	2,500	521	803
HO1981S005(04)	TRANSCONTINENTAL GAS PIPELINE	2003	MIDDLE PATUXENT RIVER	HYDROSTATIC PRESSURE TEST	18,000	3,100,000	522	829
HO1982G003(02)	LANEVE, RONALD, S.	1998	SETTERS FORMATION	CEASAR'S III RESTAURANT	2,000	2,600	533	820
HO1982G004(04)	HOWARD COUNTY DPW	2005	LOWER PELITIC SCHIST WISSAHICKON	DAYTON HIGHWAY MAINTENANCE SHOP	800	1,000	516	806
HO1983G001(03)	WEST HOWARD COUNTY SWIM CLUB	1993	WISSAHICKON FORMATION	SWIMMING POOL	500	2,000	552	779
HO1983G004(04)	CALVARY LUTHERAN CHURCH	2006	WISSAHICKON FORMATION	CHURCH-CALVARY LUTHERAN	1,000	1,700	551	777
HO1983G006(03)	IGENE BIOTECHNOLOGY	2005	LOWER PELITIC SCHIST WISSAHICKON		250	500	509	852
HO1983G008(04)	HO CO PUBLIC SCHOOLS	2007	BOULDER GNEISS WISSAHICKON FORM.	BUSHY PARK ELEMENTARY SCHOOL	3,500	5,000	534	739
HO1984G001(03)	SHEPHERD OF THE GLEN LUTHERAN	2006	BOULDER GNEISS WISSAHICKON FORM.	CHURCH	200	500	527	794
HO1984G002(03)	COMMUNITY BIBLE CHURCH HIGHLAND	2006	BALTIMORE GNEISS	CHURCH	250	600	492	813
HO1984G009(02)	HO CO DEPARTMENT OF RECREATION	1996	BOULDER GNEISS WISSAHICKON FORM.	LAND PRESERVATION FUND	200	300	542	811
HO1985G001(02)	HOWARD COUNTY RECREATION	1997	GUNPOWDER GRANITE	SCHOOLEY MILL PARK	600	2,400	486	811
HO1986G009(02)	GROUP 5 PARTNERSHIP	2002	LOWER PELITIC SCHIST WISSAHICKON	PATRICK CLARK & ASSOC. INSURANCE	100	200	480	822
HO1986G012(02)	LISBON VOLUNTEER FIRE CO.	1998	WISSAHICKON FORMATION	FIRE COMPANY	200	1,000	547	778
HO1987G003(02)	MIKOLASKO, ERIC, J.	1999	IJAMSVILLE FORM.-MARBURG SCHIST	WASHINGTONIAN LANDSCAPE CO.	600	2,400	542	761

TABLE 4
INVENTORY OF EXISTING MULTI-USE COMMUNITY WELL AND SURFACE WATER SUPPLY

Water Appropriation Permit Number and Revision	Owner	Effective Year	Aquifer	Remarks	Average Limit (gal./day)	Maximum Month Limit (gal./day)	North Coord.	East Coord.
HO1987G005(06)	LISBON PLAZA, LLC.	2014	WISSAHICKON FORMATION	LISBON SHOPPING CENTER WELL	10,000	14,500	552	781
HO1987G007(03)	CREST LAWN MEMORIAL GARDENS, INC.	2001	WISSAHICKON FORMATION	CEMETERY OFFICE	800	1,200	538	819
HO1988G003(02)	WILLOW SPRINGS I LIMITED PARTNERSHIP	2001	BOULDER GNEISS WISSAHICKON FORM.	GOLF COURSE IRRIGATION - 3 WELLS	20,000	125,000	540	809
HO1988G007(08)	SUNOCO, INC.	2009	BALTO. GABBRO COMPLEX	STATION # 0003-4587	1,000	3,000	526	846
HO1988G103(01)	WILLOW SPRINGS I LIMITED PARTNERSHIP	2001	BOULDER GNEISS WISSAHICKON FORM.	WILLOW SPRINGS CLUB HOUSE	1,000	2,000	540	809
HO1988S003(02)	WILLOW SPRINGS I LIMITED PARTNERSHIP	2001	UNNAMED TRIB	GOLF COURSE IRRIGATION, SPRING PONDS	15,000	200,000	540	809
HO1988S017(03)	COLUMBIA ASSOCIATION, INC.	2007	MIDDLE PATUXENT RIVER	HOBBIT'S GLEN GOLF CLUB	52,000	350,000	507	827
HO1989G003(03)	THOMPSON, CARL A. & SANDY, A.	2013	LOWER PELITIC SCHIST WISSAHICKON	RESIDENTIAL GWHP - RECHARGE WELL	3,000	6,000	507	797
HO1989G016(07)	TARO INVESTMENT CORPORATION	2013	COCKEYSVILLE MARBLE	BRICK HOUSE FARM BOTTLED WATER	116,000	152,000	512	817
HO1990G016(03)	CATTAIL CREEK COUNTRY CLUB, INC.	2013	BOULDER GNEISS WISSAHICKON FORM.	CATTAIL CREEK GOLF COURSE	42,000	300,000	525	787
HO1990G017(04)	HOWARD COUNTY GOVERNMENT	2011	BALTO. GABBRO COMPLEX	TIMBERS AT TROY GOLF COURSE	71,000	260,000	498	867
HO1990S016(03)	CATTAIL CREEK COUNTRY CLUB, INC.	2013	EAST BRANCH	CATTAIL CREEK GC - MAIN POND	43,000	288,000	524	787
HO1990S017(04)	HOWARD COUNTY GOVERNMENT	2011	DEEP CREEK	TIMBERS AT TROY GOLF COURSE	3,600	7,300	498	867
HO1992G015(03)	MANGIONE ENTERPRISES OF TURF VALLEY	2012	COCKEYSVILLE MARBLE	TURF VALLEY GOLF COURSE	113,000	311,000	534	833
HO1992G202(01)	WARREN H. BOYER, INC.	2004	BOULDER GNEISS WISSAHICKON FORM.	WELL FOR SHOP AND OFFICE	100	1,000	530	793
HO1992S010(02)	COLUMBIA ASSOCIATION, INC.	2005	LITTLE PATUXENT RIVER	FAIRWAY HILLS GOLF COURSE	45,000	250,000	511	843
HO1993G005(02)	WEST FRIENDSHIP CENTER, LLC.	2005	LOWER PELITIC SCHIST WISSAHICKON	HIGH'S STORE OF WEST FRIENDSHIP	200	400	536	813
HO1993S008(05)	MANGIONE ENTERPRISES OF TURF VALLEY	2012	LITTLE PATUXENT RIVER	GOLF COURSE IRRIGATION - CHANGE	40,000	580,000	533	831
HO1993S014(01)	KRATZ, CHARLES, E.	1993	MIDDLE PATUXENT RIVER	SHRUBS AND GRASSES IRRIGATION	1,200	3,000	528	808
HO1994G003(02)	WAVERLY WOODS GOLF CLUB, LLC.	2006	BALTIMORE GNEISS	WAVERLY WOODS IRRIGATION WELL(S)	14,000	72,000	538	831
HO1994G009(02)	DOWD, TIMOTHY	2007	WISSAHICKON FORMATION	TENNIS CLUB	3,000	9,000	539	785
HO1994S003(02)	WAVERLY WOODS GOLF CLUB, LLC.	2006	DAVIS BRANCH	IRRIGATION POND	60,000	450,000	538	831
HO1995G005(03)	J.R. ENTERPRISES, LLP.	2010	BOULDER GNEISS WISSAHICKON FORM.	INWOOD VILLAGE SHOPPING CENTER	5,000	7,500	535	794
HO1995G009(02)	ROMAN CATHOLIC ARCHBISHOP	2007	LOWER PELITIC SCHIST WISSAHICKON	CHURCH	1,300	2,200	478	826
HO1995G020(03)	MANNARELLI, SR., MARIO, F.	2013	BOULDER GNEISS WISSAHICKON FORM.	33-LOT SBDN	7,000	11,700	523	786
HO1996G011(02)	TARO INVESTMENT CORPORATION	2008	COCKEYSVILLE MARBLE	TARO INVESTMENT CORPORATION	500	800	512	817
HO1997G001(02)	HOWARD COUNTY DPW	2009	BALTIMORE GNEISS	HOWARD COUNTY ALPHA RIDGE LANDFILL	252,000	288,000	538	824
HO1997G004(02)	HOWARD COUNTY DPW	2010	WISSAHICKON FORMATION	CARRS MILL LANDFILL	90,000	144,000	541	785
HO1997G014(04)	GENERAL ELECTRIC COMPANY	2011	BALTO. GABBRO COMPLEX	GROUND WATER REMEDIATION	9,500	12,500	490	852
HO1997G021(05)	THE VILLAS AT CATTAIL CREEK, LLC.	2014	SYKESVILLE FORMATION	VILLA AT CATTAIL CREEK	14,000	19,600	526	788
HO1997G024(01)	STATE HIGHWAY ADMIN	1997	LOWER PELITIC SCHIST WISSAHICKON	STATE HIGHWAY SHOP	700	1,000	516	806
HO1998G002(02)	HOWARD CO BUR ENVIRONMENTAL	2010	BALTO. GABBRO COMPLEX	HO CO DPW NEW CUT LF REMEDIATION	94,000	144,000	516	857
HO1998G005(01)	JOHN FRANK, DEPUTY FIRE CHIEF	1998	BOULDER GNEISS WISSAHICKON FORM.	FIRE & RESCUE TRAINING	500	12,000	541	798
HO1998G009(01)	GLENWOOD BAPTIST CHURCH	1998	BOULDER GNEISS WISSAHICKON FORM.	GLENWOOD BAPTIST CHURCH	100	300	521	787
HO1998G010(02)	LYNNGATE PROPERTIES, LLC.	2010	LOWER PELITIC SCHIST WISSAHICKON	TERMINAL TIRES, INC.	300	500	522	803
HO1998G013(03)	HOWARD COUNTY DPW	2010	BOULDER GNEISS WISSAHICKON FORM.	WELL FOR GLENWOOD FIRE STATION	3,400	6,400	536	791
HO1999G001(01)	CHAU MINH DO	1999	WISSAHICKON FORMATION	IRRIGATION-GROW SPROUTS	200	500	552	777
HO1999G017(01)	UNITED STATES POSTAL SERVICE	1999	BALTIMORE GNEISS	UNITED STATES POST OFFICE - HIGHLAND	100	300	491	811
HO1999S004(02)	RLO CONTRACTORS INC.	2011	CHESAPEAKE BAY	COMMERCIAL	6,000	36,000	510	803
HO1999S009(02)	COLUMBIA PARK & RECREATION ASSOC.	2012	UNNAMED TRIBUTARY	PARK & RECREATION	800	2,000	504	842
HO2000G002(02)	EDDY'S WELDING	2000	COCKEYSVILLE MARBLE	EDDY'S WELDING	1,000	1,500	540	853
HO2000G004(01)	BIG BRANCH, LLC.	2000	BOULDER GNEISS WISSAHICKON FORM.	HOMEBUILDER TOLL BROTHERS	100	200	514	798
HO2000S010(01)	FOREST RECYCLING PROJECT INC.	2000	UNNAMED TRIB	FOREST RECYCLING PROJECT	7,000	20,000	511	813
HO2000S014(02)	CATTAIL CREEK COUNTRY CLUB, INC.	2013	LITTLE CATTAIL CREEK	CATTAIL CREEK GC - SWM POND	15,000	288,000	525	786
HO2001G004(02)	3881 TEN OAKS MANAGEMENT, LLC.	2005	LOWER PELITIC SCHIST WISSAHICKON	COMERCIAL & RETAIL CENTER	2,500	3,800	522	804

TABLE 4
INVENTORY OF EXISTING MULTI-USE COMMUNITY WELL AND SURFACE WATER SUPPLY

Water Appropriation Permit Number and Revision	Owner	Effective Year	Aquifer	Remarks	Average Limit (gal./day)	Maximum Month Limit (gal./day)	North Coord.	East Coord.
HO2001G007(02)	HOWARD COUNTY PUBLIC SCHOOLS	2009	LOWER PELITIC SCHIST WISSAHICKON	FOLLY QUARTER MIDDLE SCHOOL	5,000	8,000	522	805
HO2001G009(02)	GLENWOOD, LLC	2013	WISSAHICKON FORMATION	GLENWOOD, LLC	3,000	4,000	535	794
HO2002G004(01)	CHANYASULKIT, JOHN & ANNA	2002	IJAMSVILLE FORM.-MARBURG SCHIST	CHLAYASLIKIT	2,000	3,000	550	748
HO2002G007(01)	THOMPSON, DALE	2002	BALTIMORE GNEISS	HOME BUILDER/DEVELOPER	1,700	2,900	491	813
HO2002G009(02)	PULTE HOME CORPORATION	2004	ULTRAMAFIC ROCKS	PADDOCKS EAST 22 LOTS	4,700	7,800	525	806
HO2002G012(02)	WOODMONT ACADEMY, INC.	2014	BOULDER GNEISS WISSAHICKON FORM.	WOODMONT ACADEMY	8,300	11,000	541	799
HO2002G013(01)	CHASE MINING, LLC.	2003	BALTO. GABBRO COMPLEX	CHASE MINING	280,000	698,000	482	855
HO2002G015(02)	ST. JAMES UNITED METHODIST	2005	LOWER PELITIC SCHIST WISSAHICKON	CHURCH AND DAY SCHOOL	800	1,200	541	816
HO2002S006(02)	EASTER, JIM	2014	UNNAMED TRIB	PRIVATE RESIDENCE	200	300	492	814
HO2002S113(01)	CHASE MINING, LLC.	2003	BALTO. GABBRO COMPLEX	CHASE MINING	120,000	4,100,000	482	855
HO2003G006(02)	TOLL MD II LIMITED PARTNERSHIP,	2004	LOWER PELITIC SCHIST WISSAHICKON	90 LOT SBDN	19,100	31,900	510	825
HO2003G007(01)	RADUE, PETER	2003	IJAMSVILLE FORM.-MARBURG SCHIST	DAMASCUS EQUINE ASSOCIATES	300	500	542	757
HO2003G008(01)	RAPFALIDES, MARIA	2003	LOWER PELITIC SCHIST WISSAHICKON	W. FRIENDSHIP SHOPPING CENTER	4,300	6,100	535	813
HO2003G010(01)	GLYNN, JAMES & CAROLE	2003	BALTIMORE GNEISS	CONSIGNMENT SHOP	100	200	491	812
HO2003G011(01)	TRINITY QUALITY HOMES, INC.	2003	WISSAHICKON FORMATION	RESIDENTIAL-TRINITY QUALITY HOMES	4,500	7,500	543	776
HO2003G012(01)	HOWARD COUNTY CONSERVANCY	2003	BALTIMORE GNEISS	HOWARD COUNTY CONSERVANCY, INC.	600	1,200	540	833
HO2003G015(02)	HOWARD COUNTY PUBLIC SCHOOLS	2004	METAGRAYWACKE WISSAHICKON FORM.	WESTERN ELEM SCHOOL - TEN OAKS RD	2,100	7,700	513	804
HO2003G016(01)	DORSEY MILL, LLC.	2003	BOULDER GNEISS WISSAHICKON FORM.	RESIDENTIAL	5,500	9,200	520	795
HO2004G001(01)	GOOD HOPE REFORMED PRESBYTERIAN CHURCH	2004	BALTIMORE GNEISS	CHURCH	300	400	483	818
HO2004G002(01)	ST. PAUL'S EPISCOPAL CHURCH	2004	WISSAHICKON FORMATION	EPISCOPAL CHURCH	100	200	552	774
HO2004G003(01)	BORNEMANN, DVM, VALERIE	2004	WISSAHICKON FORMATION	GLENELG ANIMAL HOSPITAL	600	700	542	793
HO2004G005(01)	TOLL BROTHERS, INC.	2004	BOULDER GNEISS WISSAHICKON FORM.	27 RESIDENTIAL SINGLE FAMILY	5,800	9,700	519	795
HO2004G007(03)	HOMEWOOD, LLC.	2007	LOWER PELITIC SCHIST WISSAHICKON	HOMEWOOD, LLC - ADDING ONE LOT	17,200	28,300	516	825
HO2004G008(01)	MACBETH FARM, LLC.	2004	BALTIMORE GNEISS	RESIDENTIAL REAL ESTATE DEVEL	7,700	13,000	495	816
HO2004G010(01)	HOWARD COUNTY DPW	2005	WISSAHICKON FORMATION	GLENWOOD COMMUNITY CENTER	2,400	4,800	536	791
HO2004G011(01)	TRIADELPHIA FARM, LLC.	2004	BOULDER GNEISS WISSAHICKON FORM.	SUBDIVISION	6,000	11,400	522	790
HO2004G013(02)	LIME KILN VALLEY, LLC.	2006	LOWER PELITIC SCHIST WISSAHICKON	SUBDIVISION	7,800	13,000	480	810
HO2004G014(01)	MMGMB, LLC.	2004	BOULDER GNEISS WISSAHICKON FORM.	GENERAL OFFICE BUILDING	1,400	2,000	531	790
HO2005G002(01)	MUSGROVE FARM, LLC.	2005	BOULDER GNEISS WISSAHICKON FORM.	RESIDENTIAL SUBDIVISION	6,600	11,130	524	798
HO2005G005(01)	HIGHLAND CROSSING, LLC.	2005	BALTIMORE GNEISS	HIGHLAND CROSSING, LLC	2,000	2,500	490	812
HO2005G006(01)	HERITAGE LAND DEVELOPMENT	2006	COCKEYSVILLE MARBLE	WALNUT GROVE	19,200	32,100	508	817
HO2005G007(02)	WILLIAMSBURG GROUP, LLC.	2006	LOWER PELITIC SCHIST WISSAHICKON	RESIDENTIAL SUBDIV	4,300	7,000	512	816
HO2005G009(01)	SHALEHEARTH,LLC.	2006	BALTIMORE GNEISS	SADLEBROOK FARM 13-LOT SBDN	2,800	4,700	542	835
HO2006G001(03)	RUTAN, ROBERT	2011	LOWER PELITIC SCHIST WISSAHICKON	PRIVATE RESIDENCE DEWATERING	8,500	20,000	510	836
HO2006G002(01)	HIGHLAND DEVELOPMENT CORP.	2006	LOWER PELITIC SCHIST WISSAHICKON	RESIDENTIAL SUBDIVISION 23 LOTS	4,800	7,300	500	800
HO2006G003(01)	D.R. HORTON, INC.	2006	BALTIMORE GNEISS	TURNBURY GROVE 33-LOT SBDN	7,000	11,700	499	814
HO2006G004(01)	TOLL BROTHERS, INC.	2007	BOULDER GNEISS WISSAHICKON FORM.	EDGEWOOD FARM SUBDIVISION - 60 LOTS	12,700	21,200	519	793
HO2006G005(01)	MANNARELLI & SONS	2006	WISSAHICKON FORMATION	MANNARELLI & SONS	2,400	4,000	555	783
HO2006G006(01)	CLOVERFIELD/PFEFFERKORN, LLC.	2006	BOULDER GNEISS WISSAHICKON FORM.	CLOVERFIELD/PFEFFERKORN, LLC	4,700	7,800	535	803
HO2006G007(01)	MANNARELLI & SONS	2006	WISSAHICKON FORMATION	MANNARELLI & SONS	3,200	5,300	555	783
HO2006G009(01)	WARFIELD, JR., MR & MRS K.	2006	BOULDER GNEISS WISSAHICKON FORM.	69 LOT WARFIELDS SUBDIVISION	15,000	22,000	516	796
HO2006G011(01)	LDG INCORPORATED	2006	LOWER PELITIC SCHIST WISSAHICKON	RESIDENTIAL SUBDIVISION	4,900	8,200	540	812
HO2006G012(01)	HAILEY DEVELOPMENT, LLC.	2006	LOWER PELITIC SCHIST WISSAHICKON	HAILEY DEVELOPMENT, LC	2,750	3,300	528	811
HO2006G014(01)	LEE, BRUCE	2006	WISSAHICKON FORMATION	16 LOT SBDN	3,400	5,700	552	780
HO2006G015(01)	FULTON RIDGE, LLC	2006	LOWER PELITIC SCHIST WISSAHICKON	RESIDENTIAL SUBDIVISION	3,000	5,000	485	819

TABLE 4
INVENTORY OF EXISTING MULTI-USE COMMUNITY WELL AND SURFACE WATER SUPPLY

Water Appropriation Permit Number and Revision	Owner	Effective Year	Aquifer	Remarks	Average Limit (gal./day)	Maximum Month Limit (gal./day)	North Coord.	East Coord.
HO2006G018(01)	DAVIS BRANCH ESTATES, LLC.	2006	BALTIMORE GNEISS	MYRTUE PROPERTES	6,600	11,100	542	835
HO2006G020(02)	HERITAGE LAND DEVELOPMENT	2009	BALTIMORE GNEISS	160-L WALNUT CREEK SUBD	34,000	56,000	510	815
HO2006G021(03)	JEANNE C. HODDINOTT	2010	BALTIMORE GNEISS	ENCLAVE AT TIERNEY FARM RES SUBD	8,500	14,100	496	817
HO2007G001(01)	RIDGE VIEW, LLC.	2007	IJAMSVILLE FORM.-MARBURG SCHIST	SINGLE FAMILY HOME SUBDIVISION	3,800	6,400	546	757
HO2007G002(01)	GRAYSON DEVELOPMENT CO.	2007	BOULDER GNEISS WISSAHICKON FORM.	GRAYSON DEVELOPMENT CO.	9,700	16,200	530	787
HO2007G003(03)	SPRING MILL, LLC.	2013	BOULDER GNEISS WISSAHICKON FORM.	15-L CLOVERFIELD SECTION II RES SUBD	3,200	5,300	536	802
HO2007G004(01)	GREEN, KATHLEEN	2007	LOWER PELITIC SCHIST WISSAHICKON	CROSSROADS PUB - PDWIS# 113-1026	400	600	512	804
HO2007G005(04)	ELM STREET DEVELOPMENT, INC.	2012	IJAMSVILLE FORM.-MARBURG SCHIST	14-L CHELSEA KNOLLS RES SUBD	3,000	5,000	540	757
HO2007G011(01)	QUARTZ HILL, LLC.	2007	BOULDER GNEISS WISSAHICKON FORM.	QUARTZ HILL RESIDENTIAL SUBDIV	2,600	4,500	550	796
HO2007G012(01)	HOMEWOOD, LLC.	2007	LOWER PELITIC SCHIST WISSAHICKON	HOMEWOOD, LLC - RIVERWOOD SUBDIV	300	500	516	825
HO2007G013(01)	SKIRVEN ENTERPRISES, INC.	2008	WISSAHICKON FORMATION	29-LOT THE LEGACY RES SUBD	6,400	10,000	522	774
HO2008G001(02)	GREENFIELD HOMES, INC.	2009	BALTIMORE GNEISS	14-LOT WILLOW POND RESIDENTIAL SUBD	3,000	5,000	495	814
HO2008G004(01)	JOHNS HOPKINS UNIV/APL	2008	LOWER PELITIC SCHIST WISSAHICKON	COOLING WATER, IRRIGATION, BACKUP	5,000	10,000	487	830
HO2008G010(01)	HERITAGE LAND DEVELOPMENT	2009	BOULDER GNEISS WISSAHICKON FORM.	MERIWETHER-SECT.2, PHASE 1&2	9,700	16,200	519	791
HO2008S006(01)	THOMAS, BENNETT AND HUNTER	2008	PATAPSCO RIVER	DUST CONTROL, PATAPSCO WATERSHED	1,000	5,000	550	834
HO2008S007(01)	THOMAS, BENNETT AND HUNTER	2008	PATUXENT RIVER	DUST CONTROL, PATAPSCO WATERSHED	1,000	5,000	540	754
HO2008S008(01)	STATE HIGHWAY ADMINISTRATION	2008	PATUXENT RIVER	WATER FOR DRILLING AND CORING	300	1,000	500	860
HO2008S009(01)	RED HILL LAWN SERVICE, INC.	2008	PATUXENT RIVER	HYDROSEEDING	1,500	6,000	500	860
HO2009G001(01)	THE BRANTLEY GROUP	2009	LOWER PELITIC SCHIST WISSAHICKON	TERRAPIN CROSSING SUBDIVISION	9,900	16,600	532	811
HO2010G001(01)	VLADIMIR BLYUKHER	2010	LOWER PELITIC SCHIST WISSAHICKON	GWHP- STANDING COLUMN WELL	6,000	9,000	513	830
HO2013G001(01)	JOHNSTON CONSTRUCTION COMPANY	2013	LOWER PELITIC SCHIST WISSAHICKON	MINE CONSTRUCTION AND DEWATERING	400	1,300	603	833
HO2013S001(01)	HOWARD COUNTY DPW	2013	PATUXENT FORMATION	SEWAGE TREATMENT PLANT	1,800	60,000	470	853
HO2013S003(01)	EAST COAST GREEN, INC.	2013	CHESAPEAKE BAY	IRRIGATION	2,000	35,000		
HO2013S004(01)	J.K. PATTON TURF FARM, LLC.	2013	CHESAPEAKE BAY	IRRIGATION	3,000	21,000		
HO2013S005(01)	HOWARD CO. BUREAU OF ENV. SERVICES	2013	PATUXENT RIVER	HOWARD COUNTY ALPHA RIDGE LANDFILL	900	6,000	538	824
HO2014G002(01)	M.B. HIGHLAND RESERVE, LLC.	2014	BALTIMORE GNEISS	HIGHLAND RESERVE RESIDENTIAL SUBDIV	5,100	8,400	492	816
HO2014G003(01)	GREENBERRY, INC.	2014	LOWER PELITIC SCHIST WISSAHICKON	RESIDENTIAL SUBDIV	5,700	10,000	510	808
HO2014S002(01)	BUFFALO CONSTRUCTION COMPANY, INC.	2014	PATAPSCO RIVER	COMMERCIAL	800	4,000		

TABLE 5

INVENTORY OF EXISTING IMPOUNDED WATER SUPPLIES IN HOWARD COUNTY

Reservoir Characteristic	Municipal Reservoirs	
Name of Reservoir	Triadelphia Reservoir	T. Howard Duckett Reservoir
Owner	Washington Suburban Sanitary Commission	Washington Suburban Sanitary Commission
Crest Elevation (Feet above Sea Level)	366.4	286.4
Spillway Length (Feet)	234	190
Total Length of Dam (Feet)	995	840
Flooded Crest Above Stream Bed (Feet)	65	126
Area of Crest Elevation (Acres)	800	810
Length of Shoreline at Crest Elevation	15 miles	20 miles
Area of Land Owned (Acres)	5986	
Water Overflowed Crest First Time (Date)	1943	1954
Capacity of Reservoir (Million Gallons)	6500	6000
Safe Yield (MGD)	70	
Average Daily Withdrawals (MGD)	56	

TABLE 6

INVENTORY OF EXISTING WATER TREATMENT FACILITIES

Owner	Address	Water Source ⁽¹⁾ (PWSID No.)	Type of Treatment ⁽²⁾	Plant Coordinate Location (N; E)	Rated Plant Capacity (MGD)	Average Production (MGD)	Max. Peak Flow (MGD)	Storage Capacity (MGD)	Planned Expansion MGD/Date	Sludge Disposal Method	Operating Agency
Community Water Supplies											
Villas at Cattail Creek				587; 1,300		0.025	0.038				Private
Franciscan Fathers			PC,pH,CC	578; 1,331				0.006			Private
Non-transient, Non-Community - Institutional Use											
Howard County Bd of Education			pH,CC								HC BdEd
Bushy Park E.S.			pH,CC	595; 1,305							HC BdEd
Clarksville E.S.			pH,CC	566; 1,332							HC BdEd
Gateway			pH,CC	562; 1,328							Private
Gateway School				554; 1,332							Private
Glenelg Country School				578; 1,323							Private
Glenelg High School				586; 1,311							HC BdEd
Glenwood M.S.			pH,CC	594; 1,305							HC BdEd
Howard Vocational Tech.			pH,CC								HC BdEd
Lisbon Children Christian School											Private
Lisbon E.S.			pH,CC	605; 1,292							HC BdEd
Marriottsville Spiritual Center				606; 1,341	0.01	0.01		0.05			Private
Our Lady of Perpetual Help			PC	573; 1,378							Private
Saint Louis School			pH,CC, GAC	560; 1,328							Private
Scaggsville Public Works Annex				539; 1,340							HC DPW
Sisters of Bon Secour			F,pH	606; 1,341	0.01	0.016		0.008			Private
University of Maryland Agricultural Experiment Farm			pH,PC	579; 1,330	0.043	0.035		0.05			Private
West Friendship E.S.			pH,CC	595; 1,327							HC BdEd

Notations in Red indicate new and updated data.

TABLE 6

INVENTORY OF EXISTING WATER TREATMENT FACILITIES

Owner	Address	Water Source ⁽¹⁾ (PWSID No.)	Type of Treatment ⁽²⁾	Plant Coordinate Location (N; E)	Rated Plant Capacity (MGD)	Average Production (MGD)	Max. Peak Flow (MGD)	Storage Capacity (MGD)	Planned Expansion MGD/Date	Sludge Disposal Method	Operating Agency
Transient, Non-Community - Commercial & Institutional Use											
Bistro Blanc	3800 Ten Oaks Rd	1131064	SOFT, F, UV	583; 1,315							Private
Boarman's Meat Market	13402 Route 108	1131104	NO3, UV, GAC	551; 1,324							Private
Boarman's Foodland				550; 1,324							Private
Bureau of Highways, Frederick Rd	14212 Frederick Rd	1131105	None								HC DPW
Calvary Lutheran Church	16151 Old Frederick Rd	1131046	None								Private
Cattail Creek Country Club	3600 Cattail Creek Rd	1131068	F,pH,SOFT,CL	583; 1,303							Private
C.J.'s Beef Barn				595; 1,306							Private
Circle D Farm- Clubhouse	15535 Carrs Mill Rd	1131005	pH,SOFT	598; 1,298							Private
Circle D Farm- Pool	15535 Carrs Mill Rd	1131093	pH, F	599; 1,298							Private
Citgo Gas Station- Frederick Road	15943 Frederick Rd	1131103	GAC, UV								Private
Clarksville Vol. Fire Co.				562; 1,329							Private
Columbia One LDS Church	6020 Ten Oaks Rd	1131324	F								Private
Cooksville Carry-Out				605; 1,306							Private
County Line Deli				613; 1,341							Private
Crossroad's Pub	4809 Ten Oaks Rd	1131026	pH,SOFT,UV								Private
Crown's Pub				570; 1,348							Private
Dayton Repair & Comm Bldg	4301 Route 32	1131110	None								HC DPW
Dayton Repair Facility	4301 Route 32	1131104	GAC								HC DPW
Duke's Place				618; 1,321							Private
Evergreen Stables Farm	8250 Old Columbia Rd	1131101	None								Private
Fox Valley Pool	3320 Great Valley Dr	1131100	None								Private
Friendship Baptist Church	1391 Sykesville Rd	1131323	pH,SOFT,UV								Private
George's Superthrift											Private
Gethsemane Bapt Church	14135 Burntwoods	1131111	F,pH,SOFT								Private
Glenwood Baptist Church	3875 Route 97	1131073	F,UV								Private
Glenwood Community Center	2400 Route 97	1131318	SOFT,pH,CL	597; 1,306							Ho Co
Glenwood Library	2350 Route 97	1131320	SOFT,pH,CL	597; 1,306							HoCo
Henkel's Restaurant				531; 1,371							Private
High's-Clarksville				561; 1,329							Private
High's of Cooksville	2091 Route 97	1131091	SOFT,pH								Private
High's of Fulton	11848 Lime Kiln Rd	1131098	F	541; 1,334							Private
High's-Glenelg	3932 Ten Oaks	1131074	F, GAC								Private
High's of West Friendship	12780 Frederick Rd	1131090	F,GAC,UV								Private
Howard Co. ARC/Ellicott City				574; 1,335							Private

Notations in Red indicate new and updated data.

Nov 2015 Revision

TABLE 6

INVENTORY OF EXISTING WATER TREATMENT FACILITIES

Owner	Address	Water Source ⁽¹⁾ (PWSID No.)	Type of Treatment ⁽²⁾	Plant Coordinate Location (N; E)	Rated Plant Capacity (MGD)	Average Production (MGD)	Max. Peak Flow (MGD)	Storage Capacity (MGD)	Planned Expansion MGD/Date	Sludge Disposal Method	Operating Agency
Larriland Farms	2415 Route 94	1131052	None	600; 1,283							Private
Ledo's Pizza- Fulton Station	11845 Route 216	1131057	F, SOFT,pH,UV	540; 1,333							Private
Lee's Market				607; 1,292							Private
Lisbon BP Gas Station	15882 Frederick Rd	1131115	UV								Private
Lisbon UM Church	15875 Frederick Rd	1131020	F,SOFT,pH,UV								Private
Lisbon Vol. Fire Dept.	1220 Route 94	1131021	UV	607; 1,291							Private
Little George's				595; 1,306							Private
Lu & Joes Restaurant	1024 Ridge Rd	1131029	F,UV	611; 1,261							Private
Marshall's Pub				574; 1,317							Private
McDonalds of Lisbon	702 Lisbon Center Dr	1131080									Private
Morgan Station Inn	15400 Frederick Rd	1131028	None	606; 1,298							Private
Mountain View Inn				610; 1,260							Private
New Hope 7th Day Adventist	12350 Hall Shop Rd	1130033	None								Private
Peter Pan Day Care											Private
Pizza Hut of Lisbon	706 Lisbon Center Dr	1131082	SOFT,UV								Private
Poplar Springs Inn				610; 1,286							Private
Royal Farms Store- Clarksville	3701 Ten Oaks Rd	1131096	F,GAC,pH,SOFT								Private
Saint Andrews Epis Chapel	2770 Route 97	1131084	None	593; 1,305							Private
Saint Andrews Epis Parish	2892 Route 97	1131112	pH	593; 1,305							Private
Saint James UM Church	12450 Old Frederick Rd	1131036	F,SOFT	602; 1,328							Private
Saint Marks Epis Church	12700 Hall Shop Rd	1131107	F								Private
Saint Michaels Catholic Church	1125 St Michaels Rd	1131114	pH								Private
Schooley Mill Park	12975 Hall Shop Rd	1131056	CL	547; 1,323							Ho Co
Springs Landing Pub	17004 Frederick Rd	1131032	F,UV								Private
State Highway Administration	4401 Route 32	1131113	F,GAC								State
Sykesville Station				618; 1,321							Private
Temple Isaiah Synagogue	12200 Scaggsville Rd	1130037	F,SOFT,pH,UV	546; 1,330							Private
Ten Oaks Triangle	3881 Ten Oaks Rd	1131322	RO,pH,SOFT								Private
Thompsons Liquors				543; 1,342							Private
TRRC	3750 Shady Lane	1131097	UV								Private
Trusted System Information											Private
Turf Valley Golf Course Bath	2700 Turf Valley Rd		None								Private
W. Friendship Shopping Center											Private
West Howard Swim Club	16131 Old Frederick Rd	1131058	None	612; 1,292							Private
Western Regional Park	14800 Carrs Mill Rd	1131319	CL								Ho Co
Western Reg Pk Pavilion Well	14800 Carrs Mill Rd	1131116	CL								Ho Co

Notations in Red indicate new and updated data.

Nov 2015 Revision

TABLE 6

INVENTORY OF EXISTING WATER TREATMENT FACILITIES

Owner	Address	Water Source ⁽¹⁾ (PWSID No.)	Type of Treatment ⁽²⁾	Plant Coordinate Location (N; E)	Rated Plant Capacity (MGD)	Average Production (MGD)	Max. Peak Flow (MGD)	Storage Capacity (MGD)	Planned Expansion MGD/Date	Sludge Disposal Method	Operating Agency
Willow Springs Golf Course	12980 Livestock Rd	1131067	pH	599; 1,322							Private
Woodbine Inn	401 Woodbine Rd	1131041	UV	616; 1,294							Private
Woodstock Inn	1415 Woodstock Rd	1131042	F,UV	605; 1,349							Private
Woodstock Snowball Stand	1970 Woodstock Road	1131071		601; 1,345							Private
Transient, Non-Community - Industrial & Recreational Uses											
Belmont Conference Center - Manor House - Carriage House	6555 Belmont Woods Rd			578; 1,385							Ho Co
Church of God Campground			PC	577; 1,345							Private
Concrete Pipe and Products				543; 1,373							Private
C.R. Daniels			PC	600; 1,365		0.003		0.047			Private
Hammond Park Pool				540; 1,346							Private
Howard County Fair Grounds - Office & Dining Hall - Poultry Bldg - Main Exhibit Hall - Wash Racks - 4H Hall	2210 Fairgrounds Rd	1131050 1131075 1131078 1131076 1131088	UV	599; 1,320							Private
Hydronautics Inc.		Wells & Surface		548; 1,335							Private
Nixon's Farm Inc.	2800 Route 32	1131030	F,UV	594; 1,325							Private
Rocky Gorge Driving Range				535; 1,338							Private
Transco Company Town			None	582; 1,330		0.05					Private

NOTES:

⁽¹⁾ Water Sources are wells unless otherwise noted. PWSID= Public Water Supply ID Number.

Refer to TABLE 4 for Inventory of Multi-Use Community Wells and Surface Water Supplies.

⁽²⁾ Types of Treatment:

CC= Corrosion Control
CL=Chlorine Disinfection
F= Filtration

GAC= Granular Activated Carbon
PC= Prechlorination
pH= pH Adjustment

RO= Reverse Osmosis
SOFT= Softening
UV= Ultraviolet Disinfection

Notations in Red indicate new and updated data.

Nov 2015 Revision

**TABLE 6A
PUBLIC WATER STORAGE FACILITIES**

Facility	Road Location	ADC Map Coordinates	Overflow Elevation (Feet)	Useable Capacity (MG)
Snowden River	Snowden River Parkway	16-D11	550	2.00
Scaggsville	Clifford Ct near US Rt 29	19-B5	545	3.00
Oakland Ridge	Md. Rt 108	16-D4	630	1.50
Jonestown	Md. Rt 108	16-E5	630	0.20
Harpers Choice	Cedar Lane	15-C4	630	1.00
Bethany	Md. Rt 99	11-H4	630	0.20
Greater Baltimore Food Market	Md. Rt 175	20-J3	400	0.75
Alpha Ridge	Alpha Ridge Landfill	10-J2	730	0.30
Fulton	Md. Rt 216	18-J5	630	0.50
Marriottsville	Alpha Ridge Landfill	11-A2	630	1.25
Proposed				
New Guilford	US Rt 1	20-E5	400	2.50
Reclaimed Water				
Guilford	US Rt 1	20-E5	390	3.00*

* Useable Capacity 1.0 MG

**TABLE 6B
WATER PUMPING STATIONS**

Facility Name	Road Location	ADC Map Coordinates	Lower/Upper Zone	Existing /Design Capacity (MGD)
All Saints	Superior Avenue	19-G11	330/400	5.00
Chestnut Hill	US Rt 40	12-G5	550/630W	1.60
Columbia	Banneker Rd	15-F6	550/630W	4.00
Edgar Rd	US RT 108	16-A1	550/630E	2.80
Elkridge	Elibank Drive	17-G5	2nd Zone/550	18.00
Frederick Rd	Rt 144	11-C6	630W/730	0.58
Montgomery Rd	Montgomery Rd	12-E13	550/630E	2.60
Pine Orchard	US Rt 40	11-J7	550/630E	5.20 ⁽⁴⁾
Rt 29	US Rt 29	15-K1	550/550 ⁽²⁾	24.00 ⁽³⁾
Rt 32	Guilford Road	20-C4	400/550	Standby ⁽¹⁾
Rt 216	Rt 216	19-A5	550/630S	0.30
Maple Lawn	Maple Lawn Boulevard	19-A4	550/630S	0.30
Whiskey Bottom	Whiskey Bottom Rd	19-H9	400/550	Standby ⁽¹⁾
Marriottsville	Alpha Ridge Landfill	11-A2	630W/730	3.20 ⁽⁵⁾
Proposed				
630 West Zone	TBD	TBD	550/630W	TBD
New Whiskey Bottom	Stephens Rd	TBD	400/550	Standby ⁽¹⁾⁽⁶⁾
Reclaimed Water				
LPWRP PS	Greenwood Place	20-D9	400 Zone (reclaimed)	3.00 ⁽⁵⁾

Notes:

- 1) Pump stations designated as "standby" are utilized only during emergency periods.
- 2) Transmission Booster Station in the 550 Zone
- 3) Projected Ultimate Capacity; initial installed capacity is 16 mgd
- 4) Projected Ultimate Capacity; initial capacity is 3.7 mgd
- 5) Initial Capacity. One pump can be added to increase capacity to 5 mgd.
- 6) Projected Ultimate Capacity of 5 mgd; initial capacity of 3 mgd

TABLE 7

**INVENTORY OF GROUND WATER PROBLEM AREAS IN
HOWARD COUNTY, MARYLAND**

1.	Location:	Beaufort Park Subdivision, off Reservoir Road, South of Route 216
	Service:	No planned service area
	Nature of Problem:	Some residents have reported difficulties in obtaining adequate yields from wells.
	Planned Correction Date:	The subdivision is located outside the Metropolitan District; no service extension is planned.
2.	Location:	Lisbon, a town center on Route 144 in the western part of the County
	Service:	No planned service area
	Nature of Problem:	Lisbon is an area of older residences and business which are situated in relatively close proximity, on comparatively small lots. The results of well sampling indicate that the ground water has bacteriological contamination likely caused by subsurface wastewater disposal; and also petroleum hydrocarbon contamination possibly related to the two fuel service stations, or other sources in Lisbon. The County's consultant (KCI) obtained samples from thirty wells at twenty-nine properties in September-October 2006. The results of the sampling were as follows: the nitrate concentrations in five samples exceeded the EPA maximum contaminant level of 10 milligrams per liter; the total coliform concentrations in seventeen samples exceeded the maximum contaminant level; and in three of the seventeen samples with coliforms, E. coli were detected. Petroleum compounds have been detected in ground water at the two service stations in Lisbon.
	Planned Correction Date:	The County recommended a shared subsurface wastewater disposal facility for the Lisbon historic district. A majority of the property owners were not interested in a County owned system at this time.
3.	Location:	Ritz Estates Subdivision, north of Route 144 in the western part of the County
	Service:	No planned service area
	Nature of Problem:	Nitrate concentrations exceeding the maximum contaminant level of 10 milligrams per liter have been detected in residential wells.
	Planned Correction Date:	The subdivision is outside the Metropolitan District. No service extension is planned. Individual nitrate removal devices may be used to reduce excessive nitrates.

TABLE 7

**INVENTORY OF GROUND WATER PROBLEM AREAS IN
HOWARD COUNTY, MARYLAND**

4.	Location:	Gaither Farm Estates, on Route 108 northeast of Clarksville
	Service:	No planned service area
	Nature of Problem:	Nitrate concentrations exceeding the maximum contaminant level of 10 milligrams per liter have been detected in residential wells.
	Planned Correction Date:	The subdivision is outside the metropolitan district. No service extension is planned. Individual nitrate removal systems may be used to reduce excessive nitrates.
5.	Location:	Meadow Ridge subdivision, off Henryton Road in the northern part of the County
	Service:	No planned service area
	Nature of Problem:	Some residents have reported difficulty in obtaining adequate yields from wells.
	Planned Correction Date:	The subdivision is outside the Metropolitan District. No service extension is planned.
6.	Location:	Wynfield subdivision, off Route 144
	Service:	No planned service area
	Nature of Problem:	Some residents have reported difficulty in obtaining adequate yields from wells
	Planned Correction Date:	The Subdivision is outside the Metropolitan District. No service extension is planned.
7.	Location:	Fox Creek Subdivision, Off Route 144
	Service:	No planned service area
	Nature of Problem:	Some residents have reported difficulty in obtaining adequate yields from wells.
	Planned Correction Date:	The subdivision is outside the Metropolitan District. No service extension is planned.
8.	Location:	Monticello Drive
	Service:	No planned service area
	Nature of Problem:	The Maryland State Highway Administration (SHA) has replaced wells at four homes along Monticello Drive due high sodium chloride levels. Residents expressed concern when water heaters, shower fixtures, etc. needed to be replaced due to the corrosive nature of the groundwater with high chloride levels.
	Planned Correction Date:	The subdivisions are outside the Metropolitan District. No service extension is planned. The Health Department will continue to work with property owners and SHA to determine if alternate well sites, point of use reverse osmosis systems (RO), or whole house RO will solve the problem.

TABLE 7

**INVENTORY OF GROUND WATER PROBLEM AREAS IN
HOWARD COUNTY, MARYLAND**

9.	Location:	Friendship Manor and Fox Creek
	Service:	No planned service area
	Nature of Problem:	Some property owners in these subdivisions and the adjacent section along Frederick Road have high levels of sodium chloride. One property owner has been negotiating with the Maryland State Highway Administration (SHA) regarding the installation cost of a whole house reverse osmosis system (RO) and the associated on-site sewage disposal system upgrade required to handle the additional water discharged as a result of the RO treatment.
	Planned Correction Date:	The subdivisions are outside the Metropolitan District. No service extension is planned. The Health Department will continue to work with property owners and SHA to determine if alternate well sites, point of use RO systems, or whole house RO will solve the problem.

TABLE 8
IMMEDIATE, 5-YEAR, 10-YEAR and COMPREHENSIVE PRIORITIES for WATER SYSTEM DEVELOPMENT

Priorities Map Key (Fig 3-4)	Capital Project Number	County Priority Assigned	Coordinate Location	Description	Project Costs (\$)			Project Schedule			Pressure Zone	Model Run Year
					Total	PL660 Eligibility	Local	Prelim Plans	Start Const.	Compl. Const.		
	W-8146	In Progress	Various Sites	Resolution of easement and right-of-way issues on existing water and sewer projects.	6,000,000	-	6,000,000	on-going	on-going	on-going	N/A	N/A
	W-8206	In Progress	Various Sites	A project to fund the study, maintenance and remediation of corrosion related failures.	4,900,000	-	4,900,000	on-going	on-going	on-going	N/A	N/A
	W-8207	In Progress	Various Sites	A project to investigate and determine the condition of all prestressed concrete cylinder pipe transmission mains in the distribution system.	N/A			on-going	on-going	on-going	N/A	N/A
	W-8220 ¹	In Progress	N/A	A project for the planning, design and construction of major water facilities, mains, pumping stations, reservoirs and treatment plants in the Baltimore City Central Water System.	121,050,000	-	121,050,000	on-going	on-going	on-going	N/A	N/A
	W-8245	In Progress	Various Sites	Project to repair/repave existing county roads due to watermain breaks.	4,537,000		4,537,000	on-going	on-going	on-going	N/A	N/A
	W-8248	In Progress		Design and construction of water and sewer lines in conjunction with Maryland State Highway Administration and Howard County road projects prior to road construction.	7,650,000	-	7,650,000	on-going	on-going	on-going	-	N/A
A	W-8262	0-5 Years	1366-541	Design and construction of a 2.0 million gallon elevated water storage tank and related piping to serve the 400 Water Service Zone. (Guilford)	5,530,000	-	5,530,000	2004	TBD	TBD	400	2020
B*	W-8265	In Progress	1353-560	Rehabilitation or replacement of 1,000 linear feet of 30-inch diameter water main in the vicinity of US 29 and Broken Land Parkway.	4,480,000	-	4,480,000	2005	2011	2015	550	N/A
	W-8267	In Progress	Various Sites	Project to develop a water valve database and provide for a continuing maintenance program for exercising of valves.	1,837,000	-	1,837,000	2008	on-going	on-going	on-going	on-going
	W-8269 ²	In Progress		Design and construction of major transmission mains to convey public water from Baltimore City to Howard County. The project will fund a cost sharing agreement between Baltimore City, Baltimore County and Howard County on improvements to the Baltimore City's Western Third Zone.	35,000,000	-	35,000,000	2005	on-going	on-going	N/A	N/A
	W-8274	In Progress	Various sites	Project to Upgrade the Bureau of Utilities SCADA System.	4,834,000	-	4,834,000	2007	2007	2018		
	W-8276	In Progress	1396-568	A project to evaluate the condition of 38,000 feet of 54-inch and 36-inch PCCP water transmission mains in Baltimore and Howard Counties and to repair or replace defective portions of pipeline.	25,500,000	-	25,500,000	2005	2013	2015	N/A	N/A
	W-8289	In Progress	Various Sites	Project to replace/upgrade batteries and radio modules for the County's radio read water meter system.	16,976,000	-	16,976,000	N/A	2009	2019	N/A	N/A
	W-8290	In Progress		Project to Upgrade the Bureau of Utilities maintenance Yard.	2,680,000	-	2,680,000	2011	2015	2016	N/A	N/A
	W-8291	In Progress		Project to provide recoating/repairs of the County's Elevated Water Tanks.	6,242,000	-	6,242,000	on-going	on-going	on-going	N/A	N/A
C	W-8292	In Progress	1379-547	Design and construction of 5,500 feet of 12-inch water main and relocation of 1,500 feet of sewer main within proposed Dorsey Run Road.	1,900,000	-	1,900,000	2009	2014	2015	400	2020

TABLE 8
IMMEDIATE, 5-YEAR, 10-YEAR and COMPREHENSIVE PRIORITIES for WATER SYSTEM DEVELOPMENT

Priorities Map Key (Fig 3-4)	Capital Project Number	County Priority Assigned	Coordinate Location	Description	Project Costs (\$)			Project Schedule			Pressure Zone	Model Run Year
					Total	PL660 Eligibility	Local	Prelim Plans	Start Const.	Compl. Const.		
D*	W-8296	In Progress	1354-564	Construction of 18,000 ft. of 36" water transmission main along U.S. Route 29 from the Route 29 Pumping Station to Broken Land Parkway.	27,500,000	-	27,500,000	2010	2015	2017	550	2020
E*	W-8300	In Progress	1395-565	Construction 3,900 ft. of 12-inch water parallel transition main along Levering Ave and Main Steet.	3,286,000	-	3,286,000	2010	2015	2016	400	2020
F	W-8301	In Progress	1338-556	Construction of a water transmission main along Guilford Road from Quiet Night Ride east to W.R Grace. This main will consist of 900 ft. of 12" pipe.	420,000	-	420,000	2012	TBD	TBD	550/630-W	2020
G	W-8303	6-10 Years	1387-556	Construction of approximately 3,000 ft. of 8" and 12" water main along Loudon Avenue and the railroad from Loudon Avenue to Hanover Rd.	1,000,000	-	1,000,000	2018	2019	2020	400	2020
	W-8304	0-5 Years		A project to upgrade the Columbia Water Pumping Station.	1,250,000	-	1,250,000	2015	2017	2018	630-W	
H	W-8305	0-5 Years	1377-569	Construction of 4,300 ft. of 12" water main in Landing Road from Grovement Subdivision to Montgomery Road.	1,500,000	-	1,500,000	2018	2019	2020	550	2020
I	W-8306	0-5 Years	1341-549	630 South Zone Extension of approximately 1,000 linear feet of 12" pipe.	2,000,000		2,000,000	2015	2016	2016		2020
J*	W-8307	0-5 Years	1354-554	Construction of a water transmission main along Broken Land Pkwy. from Stevens Forest Road to Cradlerock Way. This main will consist of 4,100 ft. of 30" pipe, and will provide for improved integration of the U.S. Route 40 and Elkridge supplies.	5,000,000	-	5,000,000	2013	2015	2016	550	2020
K*	W-8308	11-15 Years	1344-547	Construction of 14,000 ft. of 24" water transmission main along U.S. Route 29 from Old Columbia Road to MD Route 216.	10,500,000	-	10,500,000	2017	TBD	TBD	550	2030
L	W-8309	0-5 Years	1368-547	Construction of a water main from Mission Road to and along MD Route 175 and across I-95 to connect to Columbia Gateway. This main will consist of approximately 9,500 ft. of 12" pipe.	2,360,000	-	2,360,000	2015	2016	2017	550	2015
	W-8312	In Progress		Design and construction of 1,200 LF of 8-inch water main from the terminus of County owned Rockburn Hill Road, west to Crossview Road to serve 6 properties	705,000	-	705,000	2014	2014	2015	550	N/A
	W-8313	In Progress	Various Sites	Project to provide on going fire hydrants inspections and maintenance.	6,000,000	-	6,000,000	on-going	on-going	on-going	N/A	N/A
	W-8314	0-5 Years		Project to study the implementation of a Reclaimed Water System.	150,000	-	150,000	2012	N/A	N/A	N/A	N/A
M*	W-8316	0-5 Years	1375-569	Replace approximately 5,800 ft. of 8" pipeline in Ilchester Road with 12" water main and/or construct additional looping	3,050,000	-	3,050,000	2014	2015	2015	630-E	2020
	W-8317	0-5 Years		Design and installation of a 1,000 kW emergency generator and electrical, mechanical and structural improvements at the Elkridge Pumping Station.	3,100,000	-	3,100,000	2014	2015	2015	550	N/A
	W-8318	0-5 Years		Project to replace approximately 12,000 ft of deteriorated 12-inch cast iron watermain, including valves, along Montgomery Road from Layers Hill to Rockburn Drive.	5,610,000	-	5,610,000	2014	2015	2016	550	N/A

TABLE 8
IMMEDIATE, 5-YEAR, 10-YEAR and COMPREHENSIVE PRIORITIES for WATER SYSTEM DEVELOPMENT

Priorities Map Key (Fig 3-4)	Capital Project Number	County Priority Assigned	Coordinate Location	Description	Project Costs (\$)			Project Schedule			Pressure Zone	Model Run Year
					Total	PL660 Eligibility	Local	Prelim Plans	Start Const.	Compl. Const.		
	W-8319	0-5 Years		Design and construction of 2,200 LF of water main and 2,200 LF of sewer to serve Blandair Regional Park.	515,000	-	515,000	2013	2014	2015	550	N/A
N	W-8320	0-5 Years		A project to relocate the Whiskey Bottom Road pumping station and related suction and discharge pipelines and to increase pumping capacity.	5,000,000	-	5,000,000	2015	2016	2017	550/400	2020
	W-8321	In Progress		Design and construction of 3,000 LF of 8" water main within the PirchWay/Aspen Drive Community.	1,315,000	-	1,315,000	2011	2015	2015	550	N/A
	W-8322	In Progress		A project to determine the condition of 44,000 LF of water main in the Wilde Lake Community area and to perform any necessary repairs of replacements.	1,700,000	-	1,700,000	2015	2016	2016	550	N/A
	W-8323	In Progress		Design and construction of a diversion structure, pumping station, elevated storage tank and reclaimed water pipelines to supply Fort Meade with reclaimed water for non-potable water use.	55,000,000		55,000,000	2013	2014	2015	N/A	N/A
	W-8324	In Progress	Various Sites	Design and construction of various water system upgrades and improvements to meet County Standards for water system redundancy, pressure and flow rates.	4,000,000	-	4,000,000	on-going	on-going	on-going	N/A	N/A
	W-8325	0-5 Years	Various Sites	Develop, design and construct a reclaimed water distribution system to serve various parts of the County with reclaimed water produced by the Little Patuxent Water Reclamation Plant.	8,465,000	-	8,465,000	2015	2016	2019	400	N/A
	W-8326	0-5 Years		Design and construction of 400 LF of 8" water main in Saint Paul Street.	400,000	-	400,000	2014	2015	2016	350	N/A
	W-8327	0-5 Years		Replacement of 2,300 LF of 8" water main in Old Lawyers Hill Road.	950,000	-	950,000	2014	2015	2017	400	N/A
O*	W-8328	0-5 Years		Design and construction of a pumping station to serve the 630-W Zone, including required piping improvements for suction and discharge.	10,000,000	-	10,000,000	2015	2017	2018	550/630-W	2025
	W-8329	In Progress	Various Sites	A project to investigate and determine the condition of all prestressed concrete cyliner pipe transmission mains in the distribution system.	4,000,000	-	4,000,000	on-going	on-going	on-going	N/A	N/A
	W-8600	In Progress		Design and construction of various additions and improvements to the water and sewer system utility or its associated infrastructure.	12,615,000	-	12,615,000	on-going	on-going	on-going	-	N/A
	W-8601	In Progress	Various Sites	A project to resolve easement and rights-of-way issues for water and sewer projects that have been constructed and special quick response projects of a capital nature that require title searches, appraisals and acquisition. Replaces W-8146 in FY2016.	N/A	-	N/A	on-going	on-going	on-going		
	W-8602	In Progress	Various Sites	Funding for design and construction of sewer and water lines in conjunction with Maryland State Highway Administration (MSHA) and Howard County road projects prior to road construction. Replaces W-8248 in FY 2016.	N/A	-	N/A	on-going	on-going	on-going		

TABLE 8
IMMEDIATE, 5-YEAR, 10-YEAR and COMPREHENSIVE PRIORITIES for WATER SYSTEM DEVELOPMENT

Priorities Map Key (Fig 3-4)	Capital Project Number	County Priority Assigned	Coordinate Location	Description	Project Costs (\$)			Project Schedule			Pressure Zone	Model Run Year
					Total	PL660 Eligibility	Local	Prelim Plans	Start Const.	Compl. Const.		
	W-8698	In Progress		A project to design and construct routine water main extensions in the Metro District request by landowners. 1. To serve existing dwelling in recorded residential subdivisions where water mains have not been constructed. 2. With existing dwellings or businesses on failing private systems identified by the County Health Department; and 3. To serve parcels with existing dwellings. The routine extensions must meet the following criteria: a. A written request has been made by a property owner who is without a water main fronting their property. b. Property to be served must abut a County or State road. c. The extension is less than 1000 feet. d. The extension must be a continuation of a water main currently in service in the same pressure zone. e. Acquisition of utility easements are not required. f. Capacity is available per section 18.122B County Code. g. Extension is supported by 50% of the property owners whose front foot benefit charges would change following construction.	6,775,000	-	6,775,000	on-going	on-going	on-going	N/A	N/A
	W-8812	0-5 Years		A project to provide construction and inspection service for sites which do not require developer agreement but require larger than 1" water house connection, fire hydrants and other water appurtenances.	252,000	-	252,000	on-going	on-going	on-going	N/A	N/A
	W-8862	0-5 Years		A project to provide for the construction of water house connections by the Bureau of Utilities for residential size (1-inch) connections. These connections are made when new connections are required for lots or homes where none exists.	552,000	-	552,000	on-going	on-going	on-going	N/A	N/A
P	Developer Project	6-10 Years	1347-595	Construction of a water transmission main from Resort Road to Bethany Lane and associated pipes. This main will consist of approximately 4,200 ft. of 12" pipe.							550	
Q	Developer Project	6-10 Years		Construction of approximately 28,000 ft. of 12" water distribution main south of Johns Hopkins Road and West of Route 29.							630-S	2010
	Developer Project	Comprehensive	1393-559	Construction of 6,500 ft. of 8" water main along Race Road from Hanover Road to the existing 8" main in Race Rd.							400/300	
	Developer Project	6-10 Years	1379-574	Construction of 8" water main connecting Landing Road to College Ave.							550	

¹ Scheduling of facilities to be determined by Water Analyzer Office and specified in Central System Report.

² Required facilities were identified in the Report on the Western Third Zone of the Baltimore Water System (August, 1984).

*Priority Projects

	In Progress
	0-5 years (2020)
	6-10 years (2025)
	11-15 years (2030)

Note: Projects which are not identified as capital projects may be constructed in the time frame indicated, or at an earlier time by a private developer if earlier construction would provide an orderly system extension.

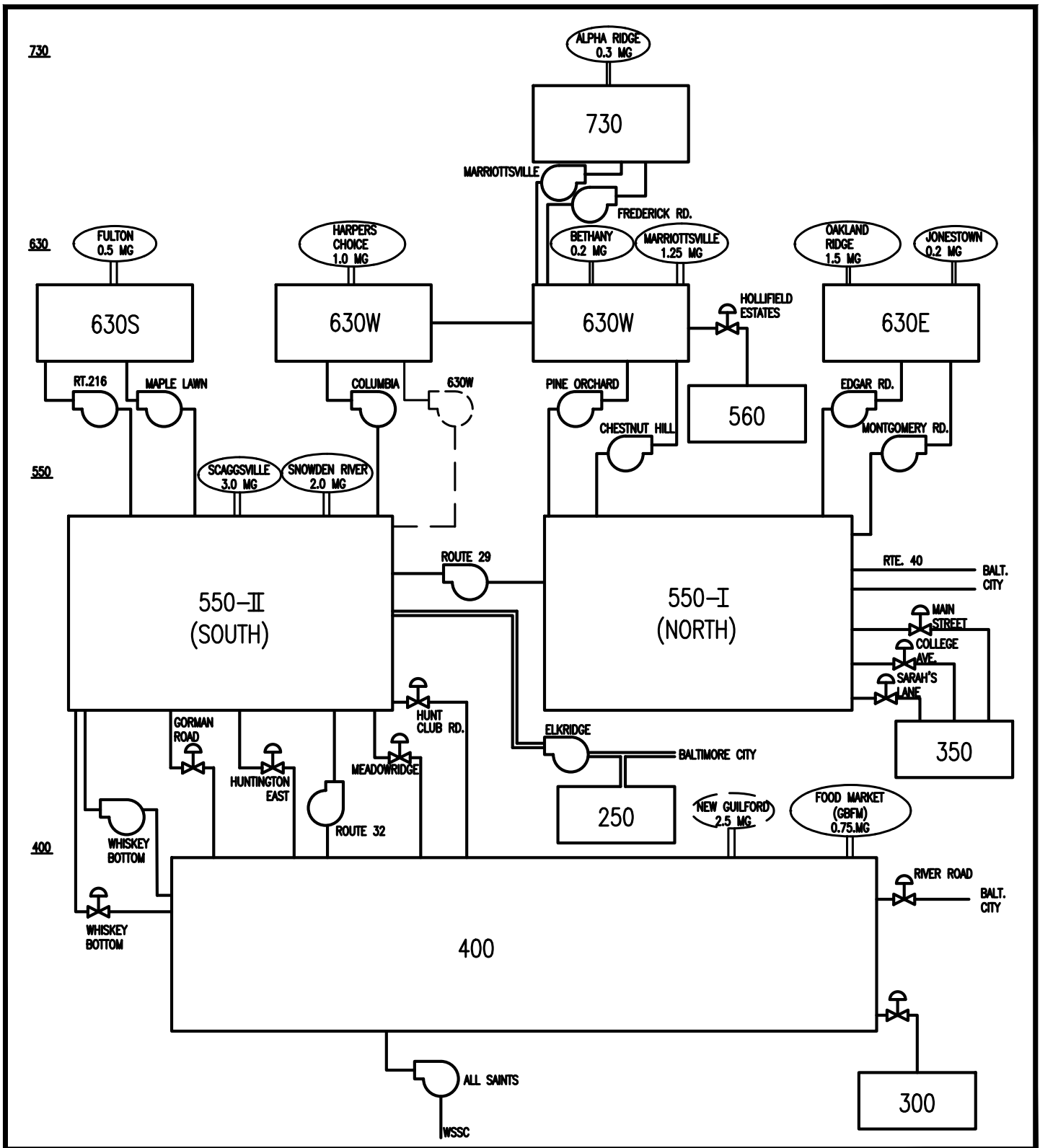

 <p>Whitman, Reardon & Associates, LLP 801 South Caroline Street, Baltimore, Maryland 21231</p>	<p>Client HOWARD COUNTY, MD.</p>	<p>WATER SYSTEM SCHEMATIC</p>
	<p>Scale: NTS</p>	<p>Date: NOV 2015</p>

Water Pressure Zones

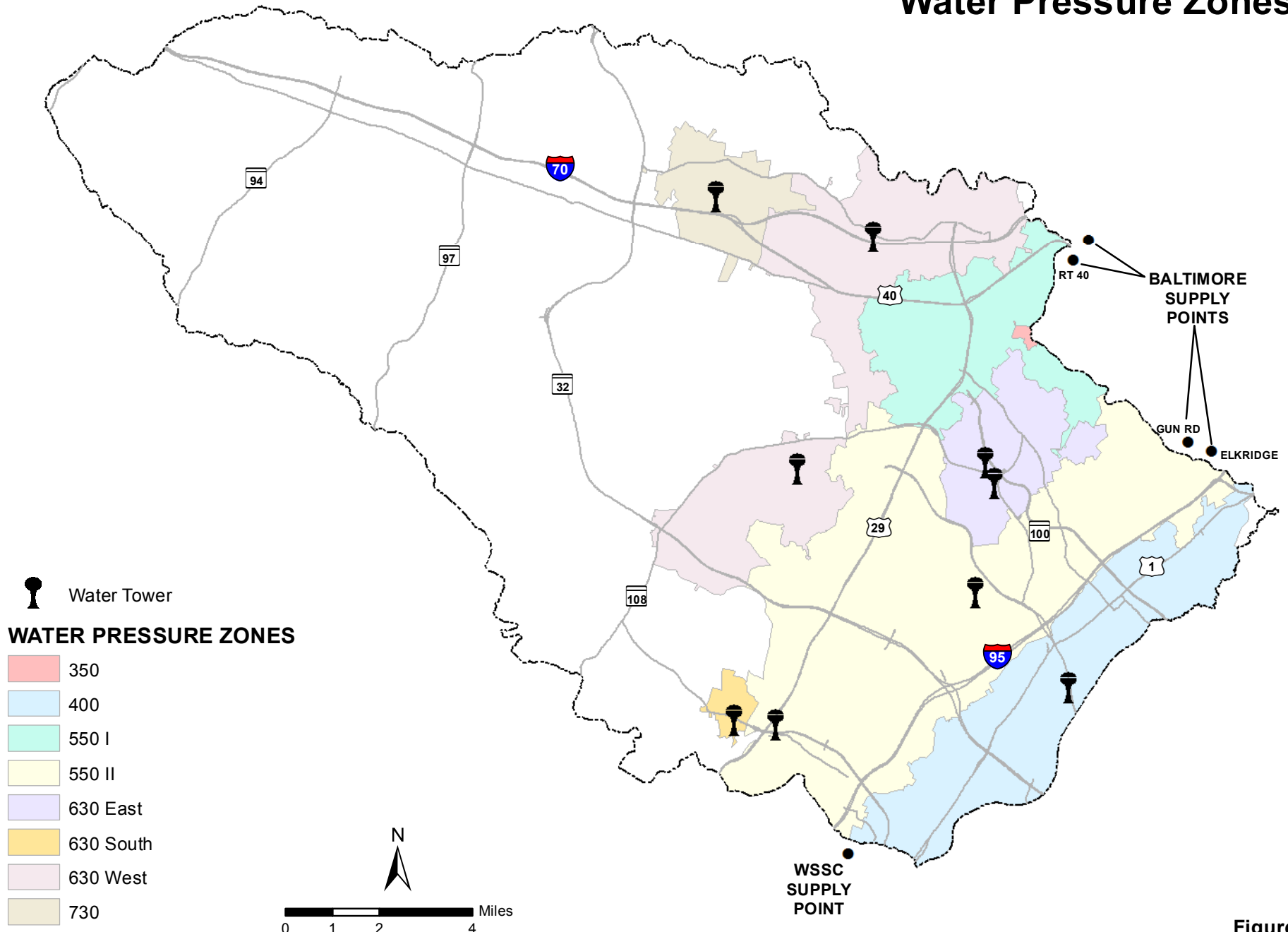
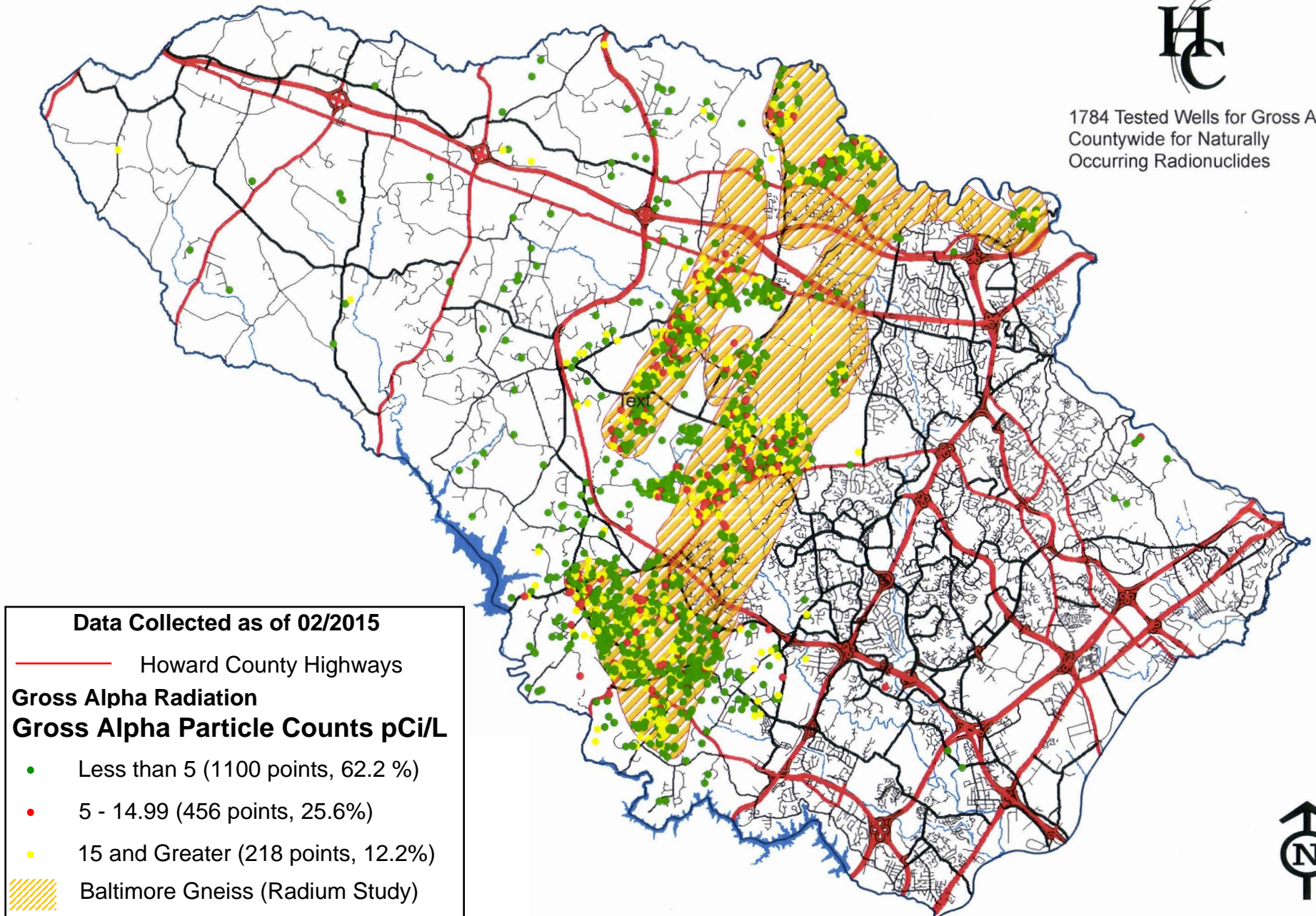

Figure 3-2

Howard County Health Department; Bureau of Environmental Health On-Going Well Radium Project (Gross Alpha Radiation)



1784 Tested Wells for Gross Alpha
Countywide for Naturally
Occurring Radionuclides



Note: Figure modified from Illustration provided by Howard County Health Department Public Information Act Request response dated 3/16/2015

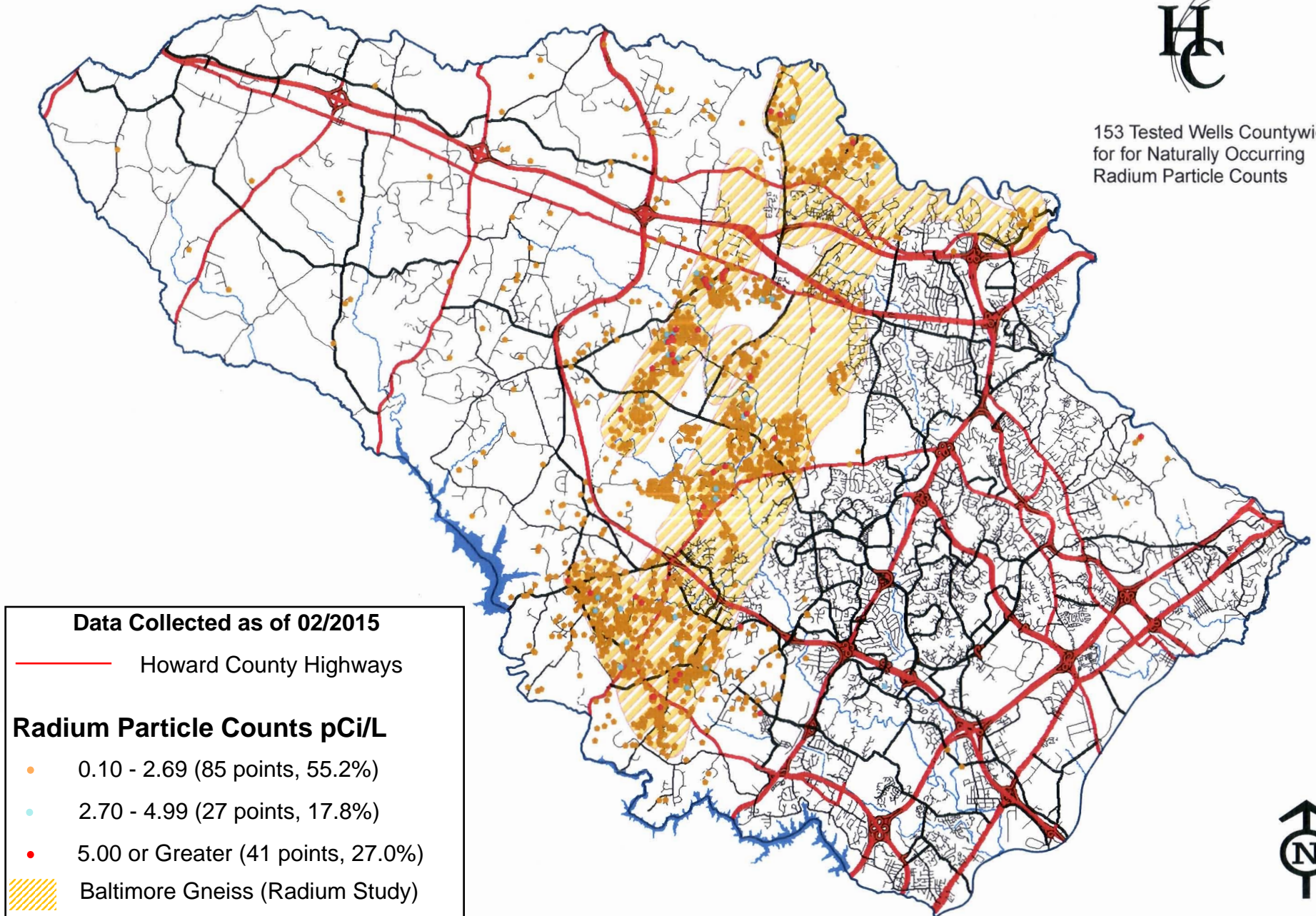

FIGURE 3-3

Howard County Health Department; Bureau of Environmental Health On-Going Well Radium Project (226/228 Particle Counts)



153 Tested Wells Countywide
for Naturally Occurring
Radium Particle Counts



Note: Figure modified from Illustration provided by Howard County Health Department Public Information Act Request response dated 3/16/2015

FIGURE 3-3A

Water Mains > 8"

WATER FACILITIES

- Pump Station, Existing
- Pump Station, Proposed
- Storage Facility, Existing
- Storage Facility, Proposed

WATER TRANSMISSION MAINS

- - - In Progress
- - - 0 - 5 years (2020)
- - - 6 - 10 years (2025)
- - - 11 - 15 years (2030)

PRESSURE ZONES

- 300
- 350
- 400
- 550 North
- 550 South
- 560
- 630 East
- 630 South
- 630 West
- 730

Capital Projects Key (Refer to Table 8)

- | | | |
|------------|------------|------------|
| A) W-8262 | F) W-8301 | K*) W-8308 |
| B*) W-8265 | G) W-8303 | L) W-8309 |
| C) W-8292 | H) W-8305 | M*) W-8316 |
| D*) W-8296 | I) W-8306 | N) W-8320 |
| E*) W-8300 | J*) W-8307 | O*) W-8328 |
- *Priority Project*
- P) DEVELOPER
Q) DEVELOPER

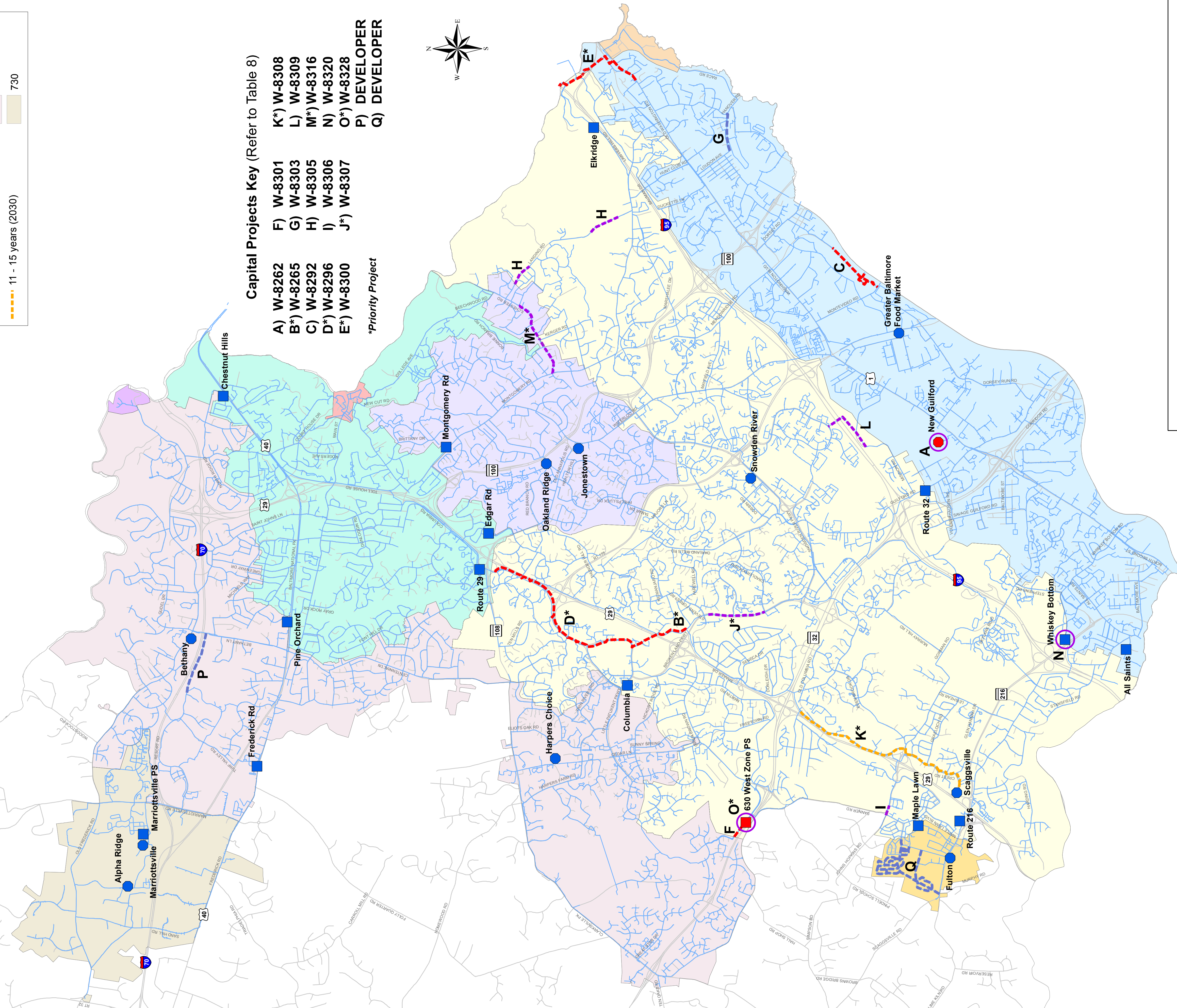
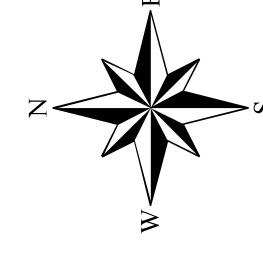

FIGURE 3-4
Immediate, 5-Year, 10-Year and
Comprehensive Priorities Plan
for Water System Development
 November 2015

CHAPTER 4

THE SEWERAGE PLAN

4.1 General

Presently, sewage flows in the County's public system are divided between two service areas. These two areas are:

- (1) The Patuxent service area, served by Howard County's Little Patuxent Wastewater Reclamation Plant (LPWRP) on the Little Patuxent River.
- (2) The Patapsco service area, served by the Patapsco Interceptor which flows to Baltimore City's Patapsco Wastewater Treatment Plant.

Since a portion of Howard County is located in the Patapsco service area, planning for sewage disposal must take into consideration the planning of neighboring counties and Baltimore City. The remaining sewage not collected by the public system is disposed of utilizing private systems, including both individual and shared sewage disposal facilities.

4.2 Sewerage Collection & Treatment Requirements

The annual average daily sewage contribution to Howard County's public sewer system in 2013 was 25.5 MGD. Approximately 19.7 MGD of flow was generated in the Patuxent drainage basin, and approximately 5.8 MGD was generated in the Patapsco drainage basin. The public sewer system serves approximately 85.6% of the County's population. By the year 2040, the public sewer system is expected to serve approximately 86.0 % of the County population. This slight variation in the percentages is considered to be “no significant change” to the projected distribution of public sewer service throughout the County during the planning period. The projected population served by the system is illustrated in Chapter 2, Table 1B.

Table 9 shows the projected sewage flows and planned treatment capacity through the year 2040 for each of the major sewer service areas. Sewer service area boundaries have been adjusted following the 2011 Master Plan to match the drainage area boundaries developed for the sewer hydraulic model and improve the accuracy of flow projections.

The area served by the Route 108 Pump Station is identified separately from the Patuxent and Patapsco service areas. Normally, flow from the Route 108 Pump Station service

area is conveyed by gravity sewer to the Little Patuxent Interceptor sewer and the Little Patuxent Water Reclamation Plant. Under adverse conditions, however, when treatment capacity at the LPWRP is limited due to factors such as plant construction, process operational limitations or abnormally high flows, the flow from the Route 108 Pump Station service area may be diverted and pumped to the Patapsco service area for treatment at the Patapsco Wastewater Treatment Plant. The Route 108 Pump Station is maintained in standby service for use as needed.

Table 9A provides a detailed breakdown of the average flows for the sub-areas that comprise the major service areas. The locations at which the sub-area flows were computed are shown on the SEWER FACILITIES PLAN MAP included in EXHIBIT 2. The projections of average daily sewage flows for the years 2015 through 2040 that appear in Table 9A are based on population and land use projections obtained from the Department of Planning & Zoning for statistical areas where sewer service is planned.

The average daily Inflow & Infiltration (I&I) flow component for 2013 was computed using the difference between the total average daily flow recorded at the County's revenue meters (sewage and all extraneous flow) and the average daily base flow during non-rainfall periods (sewage only), which was computed based on water use from the water account billing records reported in the January 2014 Water & Sewer Allocation Report.

Sewage flow projections utilized in the evaluations for the sewer hydraulic model were developed based on (1) the data collected during flow monitoring programs that took place in 2001 and 2010, and (2) the water use records for the corresponding winter quarters for 2001 and 2010. The population and development projections from DPZ were used to allocate future growth and development. The data from the existing water records, flow monitoring results and DPZ population and development projections were combined with infiltration and inflow data to develop the flow inputs for the hydraulic model using XP-SWMM software. Future residential flows were peaked based on the results of the flow metering programs and the future commercial and future industrial flows were peaked based on a synthetic diurnal pattern. The maximum infiltration and inflow utilized in the model evaluations is assumed to equal that experienced during the extreme wet weather/snowmelt event that occurred March 12–14, 2010.

It is anticipated that infiltration and inflow will be controlled through the County's regular infiltration/inflow maintenance program. This program includes flow monitoring in interceptors and collectors, smoke testing to detect inflow sources, and televised inspection of sewer lines to detect other sources of extraneous flow. Corrective measures such as sewer TV inspection, test and seal grouting, mainline sewer relining, manhole

repair, and lateral/line repair are implemented when excessive extraneous flows are found. Additional major line rehabilitation will be performed as part of the infiltration and inflow program.

In response to EPA Regulations, the Howard County Council passed, and the County Executive signed into law, two sections of the Howard County Code to regulate sewer system flows and user charges. These Code sections, which are updated on a timely basis, establish sewer use charges, excess strength surcharges, and industrial pretreatment requirements.

Howard County received EPA approval of its user charge/surcharge program and established a surcharge recovery system for the Patapsco service area in cooperation with Baltimore City.

The purpose of the User Charge Program is to recover costs for operation and maintenance of the wastewater treatment and conveyance system. Each user's charge depends upon the volume of flow discharged. For industrial sewer system users there is an additional sewer use surcharge if their wastewater discharges have concentrations of suspended solids, biochemical oxygen demand or phosphorus greater than that normally found in domestic sewage.

A. Pre-treatment Program

Industries desiring to connect to the system are evaluated on a case-by-case basis. If the quantity or quality of the industry's discharge would interfere with or otherwise adversely affect the treatment capabilities of the treatment plant; or if the discharge contains materials which would damage the conveyance system or components of the treatment process; or if pretreatment standards would be violated, the County will require pretreatment of the waste prior to discharge.

The requirements for pretreatment are established by the County, based in part on standards developed by EPA. Local standards have been developed to protect operation of the Little Patuxent Water Reclamation Plant and to control the quality of sewage biosolids produced. The biosolids, which are primarily disposed of by surface application on agricultural land, must conform to contamination limitations established by regulations of the Maryland Department of the Environment (MDE).

Howard County began development of its Pretreatment Program in June, 1982. The Program was approved by MDE in August, 1985 and has since undergone periodic updates with current modifications being implemented as part of the Howard County

Consent Agreement with MDE (See paragraph below). The development of discharge standards is coordinated with Baltimore City so waste discharges to the Patapsco sewerage system will meet requirements established by the City. Details related to program operation may be found in the three volume report titled Howard County Industrial Wastewater Pretreatment Program. The bio-solids program for Howard County currently relies on the production of a Class A sludge (refer to Sludge Disposal section of this chapter).

B. Sewer Service Priority Categories

As specified in Chapter 1, parcels of property in the Planned Service Area are assigned sewer service priorities. Periodically, the Master Plan is amended to account for changes in service priorities as a result of subdivision and land development activity and capital construction. The SEWER FACILITIES PLAN MAP and the accompanying Table of Sewer Facilities Map Revisions provided in EXHIBIT 2 have been revised and updated to show service priority revisions for County capital and private development activities through December 2014. The following types of revisions have been incorporated into the 2015 Water & Sewer Master Plan and shown on the SEWER FACILITIES PLAN MAP:

1. Changes in Capital Project Scopes and Schedules- As capital projects progress from the planning phase to construction, the priority designations assigned to the properties served by these projects must be updated. The criteria for determining the appropriate priority designations are described in Chapter 1.
2. Changes in Status of Private Development- As planned private development progresses through the plan review and approval processes administered by the Department of Planning & Zoning (DPZ), the Master Plan priority designations for affected properties must be revised and updated in accordance with Chapter 1 criteria. These revisions are of particular importance since MDE will only approve water or sewer construction permits for proposed development that is assigned a priority that specifies service within five years.
3. Entries into or Removals from the Metropolitan District- Properties that have been incorporated into the Metropolitan District, or removed from the Metropolitan District require revision of the Metropolitan District boundaries shown on the Sewer Facilities Plan Map.

4. Addition to the Planned Service Area- Properties that have been added to the Planned Service Area in accordance with amendments to the Howard County General Plan 2000 and adoption of PlanHoward 2030 are incorporated into the Planned Service Area for Sewerage to provide consistency with the General Plan. Refer to the Planned Service Area section of Chapter 1.

4.3 Consent Agreement

In March of 2010, the Howard County Department of Public Works (DPW) entered into a Consent Agreement with MDE to take corrective actions on its sanitary sewer collection and treatment system in order to prevent sanitary sewer overflows (SSO's). Howard County agreed to a series of corrective measures including the development of a Capacity, Management, Operation, and Maintenance (CMOM) program along with performing Sanitary Sewer Evaluation Surveys (SSES) for each of its drainage basins.

As part of the CMOM program, DPW is proactively performing a systematic sewer cleaning, inspection, televised inspection, smoke testing, flow monitoring, and repair program based on metrics developed in the CMOM manual. The manual was submitted to and approved by MDE on June 30, 2011, and is currently being implemented. Howard County DPW created a full time position of "CMOM Manager", who along with an outside consultant is responsible for complete program development and insuring that milestones in the approved CMOM are being met. In-house DPW maintenance crews as well as outside contractors perform the necessary field work to insure compliance.

DPW also retained the services of two (2) outside consultants to conduct Sanitary Sewer Evaluation Surveys (SSES) for each of its drainage basins. The SSES for the Little Patuxent basin was submitted to MDE in May of 2010, and the Hammond/Guilford and Patapsco studies were submitted in 2011. Work identified in the LP basin SSES is underway. Construction of the new Little Patuxent Parallel sewer was completed in 2014. Various manhole and sewer deficiencies identified in the Little Patuxent SSES, as well as deficiencies discovered in the Hammond/Guilford and Patapsco/Deep Run basins are being corrected under the CMOM implementation program.

In addition to the SSES projects, flow monitoring programs utilizing hydraulic modeling and field flow measurements are being used to identify various sewer segments requiring additional capacity. The DPW Sewer Capital Improvements Program (CIP) has been updated to include new projects resulting from these analyses and is included as part of the Master Plan.

Amendments to the Howard County Fats, Oils, and Grease (FOG) program have been developed and updated as part of the Consent Agreement, and are currently being implemented.

Howard County DPW is fully committed to performing the sewer system maintenance and conducting the capital improvements work necessary to eliminate and/or minimize sanitary sewer overflows (SSO's) from its sanitary sewer collection and treatment system.

4.4 Sewage Disposal – Private Systems

Private individual septic systems presently serve approximately 14% of the population in Howard County and several commercial and industrial establishments. The efficiency of a septic system depends on soil characteristics. In July, 1968, the United States Department of Agriculture, Soil Conservation Service issued the results of a soil survey for Howard County. Accompanying the detailed description of soils in the publication are aerial maps detailing each soil area in the County. The survey indicates that the use of septic systems is severely limited for 47% of the County due to soils characterized by low permeability, shallow depth to bedrock or seasonal high water table. An additional 19% of the County is rated as having moderate limitations for the use of septic systems. 34% of the County's soils are rated as having slight limitations. Although severe limitations do not prevent the use of septic systems, special construction practices may be necessary to obtain County approval.

Private septic systems will continue to be used in the western portion of the County, while the use of private septic systems within the Metropolitan District will decrease as connections are made to the public sewerage system.

Private wastewater treatment plants other than septic systems are listed in **Table 10**. The County anticipates that industrial, commercial and institutional facilities located in the planned service area will eventually connect to the County's public sewerage system, provided they comply with capacity allocation and pretreatment requirements. Conveyance system improvements will be designed to accommodate flows from these facilities. Expected dates of abandonment have not been established for all of the facilities given in Table 10. **Table 10A** lists existing and planned wastewater discharges for which NPDES permits have been applied for or issued. **Table 10C** lists a summary of existing and planned community septic systems for facilities that have been assigned a permit number or have applied for one.

Wastewater disposal problem areas are inventoried in **Table 11**. The majority of the problem areas identified involve subdivisions where existing septic systems are failing. Areas with failing septic systems which can be served through an extension of the existing sewerage system are planned for service in accordance with schedules given in Table 13. Properties with failing septic systems outside the Planned Service Area will continue to be served by private on-site systems unless the properties are immediately adjacent to the PSA, have public sewer available as determined by the Director of Public Works, and have been ordered to connect to the public sewer by the County's Environmental Health Department. Therefore, existing failed systems will require replacement or repair in conformance with County Environmental Health standards.

Howard County DPW immediately responds to reports and complaints or observations of illicit discharges to streams. There are no known water quality problems resulting from storm drainage outfalls and non-point sources to report via Table 12, so Table 12 is not included in this report.

4.5 Shared Sewage Disposal Systems

Undeveloped properties zoned RR and RC within the No Planned Service Area may be serviced by shared sewage disposal facilities. Howard County Code Title 18, Subtitle 12, and Title 20, Subtitle 8 establishes requirements and procedures for shared disposal facilities to serve cluster development permitted on RR and RC zoned land. These systems are proposed and constructed by private developers of residential subdivisions, and are designed to serve individual residential lots within a contiguous subdivision. Public facilities such as schools may also be included in a shared sewage disposal system (SSDS) owned and operated by the Board of Education. Shared sewage disposal facilities are designed in accordance with Department of Public Works standards and those of the County Health Department and MDE. Each system must be reviewed and approved by the Department of Public Works, County Health Department, and MDE prior to construction.

Facilities generally consist of gravity collection systems or pressure collection systems with pumps located in easements on individual lots. All wastewater is collected and treated at a single, contiguous treatment area (primary treatment). After treatment, the wastewater is distributed to a subsurface soil absorption field.

Shared Sewage Disposal Systems with maximum daily design flow (MDDF) over 10,000 gallons per day (gpd) require a MDE Groundwater Discharge Permit. The Department of Public Works will approve and accept only those proposed public large systems (\geq 10,000 gpd MDDF) that were identified and included in the January 2006 amendment to the Water and Sewer plan.

MDE Groundwater Discharge Permits require that wastewater must be treated at the headworks so that it contains no more than 30 parts per million (ppm) of BOD, 30 ppm TSS and 10 or 8 ppm total nitrogen before the wastewater enters the subsurface soil absorption fields. Nutrient removal technologies are needed to meet the treatment levels required by the permits. Nutrient removal technologies treat wastewater by subjecting it to an aerated zone or cycle, an anoxic zone or cycle, and clarification before distribution to the subsurface soil absorption fields. Sludge management systems are included with nutrient removal technologies to control solids inventory and minimize waste hauling. DPW will only accept nutrient removal technologies that have demonstrated successful BOD, TSS and nutrient removal at a facility within Maryland. The large, permitted systems will be owned and operated by the developer until one year following 80% occupancy of the homes connected to the system.

At the discretion of MDE, SSDS with MDDF between 5,000 and 10,000 gpd may be subject to a Discharge Permit if MDE is concerned with soil, hydraulic, or nutrient migration conditions. MDE may also require a Discharge Permit for SSDS and systems with less than 5,000 gallons MDDF that serve 6 houses or more if there are nutrient migration concerns. Homes within developments identified as having nutrient migration concerns may be required to have an on-site treatment system located on individual lots.

Smaller shared sewage systems with MDDF less than 5,000 gpd and less than 6 homes do not require a discharge permit under most circumstances. MDE reserves the right to place restrictions or apply permits to any systems that may increase the nitrogen content of ground or surface waters at significant levels deemed injurious to the Chesapeake Bay. MDE requires the pre-treatment of wastewater through the installation of Best Available Technology (BAT) for the removal of nitrogen. BAT systems shall be owned and maintained by the Department of Public Works. Primary treatment for the small, non-permitted systems in Howard County consist of septic tanks in a series that provide solids removal and the digestion of organic matter.

Shared sewage disposal facilities that do not require MDE discharge permits, and their related easements, become County property after construction. A developer's agreement, declaration of covenants, and deed of shared sewage disposal facility easement must be

signed and in effect before the County takes full ownership of the system. For the large permitted systems, in addition to the above mentioned documents, the property containing the treatment system and subsurface absorption fields will be deeded fee-simple to the Department of Public Works. Facilities operation and maintenance is the responsibility of the Department of Public Works. The users of the shared systems finance the maintenance of these systems through an annual payment of fees. **Table 10B** lists existing and planned shared sewage disposal facilities.

4.6 Sewage Conveyance and Treatment - Patapsco Basin

Presently, the Patapsco Interceptor, which is shared by Howard County, Baltimore County, Anne Arundel County and Baltimore City, receives sewage from Howard County at four metered connections: the Deep Run, Bonnie Branch, Tiber Branch and Sucker Branch Interceptors.

The Furnace Avenue meter in Elkridge registers the flow from the Deep Run Interceptor serving most of the U.S. Route 1/Interstate 95 corridor from Elkridge to Waterloo and Jessup, and includes sewage flow from Anne Arundel County through various sewage flow meters and direct interceptor connections. The Bonnie Branch Interceptor connects to the Patapsco Interceptor at Illchester Road and serves the Illchester, Worthington and Rockburn Park areas. The Main Street meter in Ellicott City registers flow from the Tiber Branch Interceptor which serves Ellicott City and areas immediately west of Route 29. The Route 108 Pumping Station is also tributary to the Tiber Branch Interceptor. Its discharge will flow through the Main Street meter when the pumping station is in operation. The Sylvan Lane meter registers flow in the Sucker Branch Interceptor, which serves the area north of Ellicott City and west to Mount Hebron

Collected flow data is used to analyze system flows and to determine the County's share of operating and maintenance costs for the Patapsco interceptor, pump station, and Patapsco Treatment Plant. Several agreements have been developed and approved between Howard and Baltimore Counties concerning the sharing of costs and capacity in the Patapsco system. The first agreement, executed on May 6, 1963 and later modified on February 28, 1964, provided for construction of the Patapsco Interceptor from Herbert Run to the Deep Run Interceptor and from the Deep Run Interceptor to Oak Forest Branch. In addition, the agreement provided for construction of the interceptor from Sucker Branch to a point 3,500 feet south of Ellicott City, terminating at a temporary treatment plant which has since been deactivated.

The second agreement, dated August 2, 1968 provided for construction of the Patapsco Interceptor from Oak Forest Branch to the temporary treatment plant specified above.

The third agreement, dated June 4, 1979 updated portions of the previous agreements, specified new cost sharing criteria, and established a peak flow limitation for Howard County at the Patapsco Pump Station of 17.8 MGD. The agreement was amended on June 5, 1982 to address conditions for construction of the parallel Patapsco Relief Interceptor. This amendment specified cost sharing arrangements and provided Howard County with a peak flow capacity downstream from the Deep Run Interceptor to the pump station of 27.6 MGD.

The fourth and final agreement, dated May 3, 1982, specified peak flow capacity purchased by Howard County in segments of the Patapsco Interceptor located upstream of the Deep Run Interceptor. The allocated capacities are given below:

INTERCEPTOR SEGMENT	ALLOWABLE PEAK FLOW(MGD)
Deep Run to Bull Branch	16.1
Bull Branch to Tiber Branch	15.1
Tiber Branch to Sucker Branch	4.0

The Patapsco Sewage Pump Station was planned for an initial flow of 45 MGD with provisions for future expansion to 70 MGD, and a current capacity of 59 MGD. Howard County's contracted share of the pump station's peak capacity is 39.6%. Therefore, when the pump station is upgraded to accommodate projected flows, Howard County is to assume the costs for providing 27.6 MGD of the total 70 MGD capacity. This capacity share will be adequate to provide for the County's needs until after year 2040.

The Patapsco 201 Facilities Plan indicates that the current 2-year frequency peak flow to the Patapsco Pump Station is conservatively estimated to be 61.9 MGD. The difference between this flow rate and the initial pump station capacity of 41.5 MGD can be attributed to higher than anticipated flows from the Baltimore County portion of the service area. In 1985, Baltimore County installed a third pump in the station that increased the safe capacity to 59 MGD. The station was designed to allow for a fourth pump to be installed which would increase the safe capacity of the station to 70 MGD. The Patapsco 201 Plan also recommends an immediate increase in the station's safe capacity to at least 91 MGD which will be required to provide for future growth. The increase in future station capacity from 70 MGD to 91 MGD is necessary to accommodate flows from Baltimore County, which will be higher than originally projected.

The table below addresses capacity allocations for Howard County in the Patapsco interceptor. It was determined that existing allocations may not supply adequate capacity for all contributing jurisdictions, and Baltimore County's current 2-year frequency peak flow may exceed that jurisdiction's allocation in the interceptor between manhole no. 34848 and the Patapsco Pump Station and in the pump station itself. Flow allocations are specified in the June 4, 1979 agreement and the June 5, 1982 amendment. Howard County's capacity allocation and projected peak flows in sections of the Patapsco Interceptor are as shown below:

BRANCH DISCHARGE LOCATION	CUMULATIVE PEAK DESIGN FLOWS (MGD) IN PATAPSCO INTERCEPTOR ⁽²⁾		CONTRACTED PEAK FLOW CAPACITY (MGD)
	2014	2040	
Sucker Branch	3.58	4.04	4.0
Tiber Branch	5.28	5.78	15.1
Bonnie Branch	6.83	7.58	15.1
Deep Run ⁽¹⁾	12.15	14.82	27.6

(1) – Includes flow from Anne Arundel County

(2) – Excludes flow from Baltimore County

It has been determined that, based on present flow projections and increased levels of infiltration/inflow reduction, adequate interceptor hydraulic capacity is available to Howard County for the projected year 2040 flows. A reallocation of available capacity and cost shares through inter-jurisdictional agreements may be necessary to provide for each jurisdiction's needs as conditions within the drainage basin change.

Four agreements are in effect between Howard County and Anne Arundel County concerning construction cost and capacity allocation for the Deep Run Interceptor. The first agreement, dated August 28, 1963, covered the construction of the interceptor from the Patapsco Interceptor to Elkridge. This agreement provided a peak capacity of 4.42 MGD to Anne Arundel County and the remainder of the rated 10.4 MGD total capacity to Howard County. A 33" diameter parallel sewer line was constructed under County contract 10-1809 to provide adequate capacity to convey Howard County flows. In addition, a 400 ft. section of the existing 33" diameter line was rerouted and replaced with a 42" diameter line to accommodate the construction of Interstate Route 195. The siphon structure crossing the Patapsco River was reconstructed in 2005 under County contract 10-4109 to accommodate the projected flows as well as provide for a future third

siphon barrel that is currently under construction. Anne Arundel County informed Howard County that their existing capacity allocation of 4.42 MGD is adequate to meet future needs. Therefore, the provision of the increased capacity was funded entirely by Howard County.

The second section of the Deep Run Interceptor, between Elkridge and Hanover Road, was constructed under an agreement dated June 30, 1970, which allotted to Howard County a peak flow limitation of 19.78 MGD. The third agreement, dated December 11, 1973, covered the extension of the interceptor from Hanover Road to the town of Dorsey, Maryland. This agreement divides the portion of the interceptor addressed into three segments with capacity allocations as specified below:

INTERCEPTOR SEGMENT	ALLOWABLE PEAK DESIGN FLOW (MGD)
Hanover Road to Piney Run	12.48
Piney Run to Licking Creek	11.96
Licking Creek to Dorsey	5.8

The interceptor portion between Licking Creek and Dorsey serves Howard County only. Therefore, Howard County's flows in this segment are limited by the hydraulic capacity of the interceptor.

On March 30, 1979, Howard County and Anne Arundel County entered into an agreement to construct the Licking Creek Interceptor, a tributary to the Deep Run Interceptor along Licking Creek and Montevideo Road. This agreement includes cost sharing provisions and allocates peak flow capacity to Howard County of 1.76 MGD. Howard County's capacity allocations and projected peak flows in the Deep Run Interceptor are shown in the table that follows:

LOCATION ON DEEP RUN INTERCEPTOR	PROJECTED PEAK DESIGN FLOWS (MGD) ⁽¹⁾		CONTRACTED PEAK CAPACITY (MGD)
	<u>2014</u>	<u>2040</u>	
Patapsco Interceptor to Elkridge (Contract 22-S)	6.83	7.66	14.70
Elkridge to Hanover Road (Contract 181-S)	6.01	6.46	19.78
Hanover Road to Piney Run (Contract 291-S)	3.85	4.24	12.48
Piney Run to Licking Creek (Contract 291-S)	3.84	4.23	11.96

(1) –Excludes flow from Anne Arundel County

Sewer restrictions were imposed in the Patapsco service area in 1974 as a result of the limited treatment capacity of the Patapsco Wastewater Treatment Plant. With the enactment of the County's present water and sewer capacity allocation law in 1979, the lack of treatment capacity resulted in a complete moratorium on new connections. To provide relief from the moratorium, Howard County constructed a 1.0 MGD interim wastewater treatment plant located on the Deep Run tributary to the Patapsco River. All of the sewage flow in the Deep Run Interceptor at this point was diverted to the interim treatment plant.

In 1983, additional capacity became available at the Patapsco Wastewater Treatment Plant. Sufficient capacity was allocated to Howard County to allow for the Deep Run Plant to be taken out of service in December, 1984. The interim plant was maintained in a standby capacity. The County subsequently completed a study of the Deep Run Plant to determine if the plant could be modified to meet more stringent discharge limits that would be imposed by the State should the County need to reactivate the plant. It was determined that extensive modifications would be necessary to meet current NPDES discharge standards. Since the expansion of the Patapsco plant was completed, the Deep Run plant is targeted for demolition. Howard County will retain ownership of the plant site.

In May, 1984, the jurisdictions contributing flows to the Patapsco Wastewater Treatment Plant entered into a Memorandum of Understanding which is included in this Plan as EXHIBIT 8. This memorandum specifies shares of the total design treatment capacity of

the Patapsco Wastewater Treatment Plant owned by each jurisdiction. The capacity shares are as follows:

<u>JURISDICTION</u>	<u>CAPACITY SHARE (MGD)</u>
Howard County	10.0
Baltimore City	19.6
Baltimore County	34.7
Anne Arundel County	<u>5.7</u>
TOTAL	70.0

The May 1984 memorandum also describes capacity allocation procedures and the method to be used in computing future capacity allocations for each jurisdiction. Baltimore City undertook a 17.5 MGD incremental expansion of the existing facilities to a total design capacity of 87.5 MGD. The 17.5 MGD expansion completed in 1998 included the addition of a single pure oxygen activated sludge reactor to the existing process train; incorporated three primary settling tanks, one secondary clarifier, and one chlorine contact basin. Two of the primary settling tanks replaced six old primary tanks to provide redundancy for maintenance purposes. Biological nutrient removal (BNR) was incorporated into the treatment process. Howard County's share of the incremental capacity increase was 2.4 MGD, bringing the County's total planned capacity share to 12.4 MGD.

Enhanced Nutrient Removal (ENR) upgrades to the Patapsco plant are currently underway and may result in a reduction of plant capacity. The planned capacity of the plant is 81 MGD and the County's total share capacity is projected to be approximately 11.4 MGD. As of December 31, 2014, the NPDES permitted capacity of the Patapsco WWTP was 73.0 MGD.

4.7 Sewage Conveyance and Treatment - Patuxent Basin

The Little Patuxent Water Reclamation Plant (LPWRP) is currently the only municipal wastewater treatment facility operated by the Howard County Department of Public Works in the Patuxent Basin. The first treatment unit of the contact stabilization type with a capacity of 1 MGD was completed and put into service in November, 1965. Additional construction over the years has brought the present (2015) NPDES permitted annual average hydraulic capacity to 29.0 MGD, with associated nutrient loading caps of 309,715 lbs of Total Nitrogen (TN) per year and 23,258 lbs of Total Phosphorous (TP) in the effluent per year. Projected demands and planned capacity for the Patuxent service

area are given in **Table 9**. A diagram of the present treatment processes at the Little Patuxent Plant is shown in **Figure 4-1**. The site plan for existing facilities is shown on **Figure 4-2**.

The highest single day flow through the LPWRP was 36.74 MGD on September 9, 2011. The highest hourly flow experienced was 47.45 MGD, occurring at 10:00 pm on March 10, 2011.

The Patuxent River Basin Water Quality Management Plan, prepared under Section 303 (e) of the Federal Water Pollution Control Act Amendments of 1972 by the State Water Resources Administration, includes the Little Patuxent Water Reclamation Plant as a permanent component of the region's sewage treatment facilities. The State Department of the Environment and EPA expressed concern regarding the health impacts related to an effluent discharge into the Little Patuxent River at the plant site. The intake for Fort Meade's water treatment facility is located approximately four miles downstream from the Little Patuxent Plant. The Howard County Department of Public Works evaluated several alternatives to alleviate potential health concerns in a report titled Savage Wastewater Treatment Plant Discharge Evaluation (October, 1976). The alternative recommended and implemented extended the effluent discharge to a point below the Fort Meade water intake through construction of a 54 inch diameter pipeline parallel to the Little Patuxent River. The NPDES Discharge Permit for this effluent discharge point is included as EXHIBIT 9. With the deactivation of the Fort Meade Water Treatment Plant, Anne Arundel County has removed the intake from service and currently relies on groundwater.

The fourth addition to the plant expanded its capacity to 15 MGD, including primary and secondary treatment, nitrification, phosphorus removal, filtration, disinfection, and sludge handling facilities.

In 1989, Howard County entered into a Phase I BNR Agreement with the Maryland Department of the Environment which required the County to implement Biological Nutrient Reduction (BNR). The fifth addition to the Little Patuxent Water Reclamation Plant, which was in response to this Phase I Agreement, was completed in 1994. This addition utilized BNR technology for both nitrogen and phosphorus removal. The facilities provided a total capacity of 20 MGD, which provided for the plant needs through Year 2005.

Howard County entered into a Phase II BNR agreement with the Maryland Department of the Environment in 1994 to determine the technical feasibility of further reductions in total nitrogen removal to a seasonal level of 3 mg/l using increased internal recycle as

well as methanol addition. The results of that study as well as a demonstration scale test determined that it was not technically feasible using the methodologies described.

The sixth addition to the Little Patuxent Water Reclamation Plant was completed in 2004. This addition upgraded the hydraulic capacity of the plant to 25 MGD, and provided for additional nitrogen reduction and enhanced solids handling capability. The plant incorporated the modified Johannesburg process, which is a further refinement of the BNR process. Construction of this expansion helped further reduce the total nitrogen discharge, and enhanced the solids handling and treating ability by adding centrifuges for dewatering. This expansion provided hydraulic capacity for the sewage projection through Year 2020 in the basin including the Route 108 Pumping Station tributary.

The seventh (7th) addition to the Little Patuxent Water Reclamation Plant for Enhanced Nutrient Removal (ENR) facilities was completed in 2012 to further reduce total nitrogen and phosphorous in the effluent. The County is pursuing grant opportunities with the Maryland Department of the Environment to obtain Bay Restoration Funds as well as State Revolving Loan Funds to help finance the project.

Previously, the County acquired a vacant property adjacent to the plant. This property may be utilized for any additional treatment capacity expansion or sludge management facilities beyond what can be built on the existing plant site, if needed. This property is "Parcel 165" located adjacent to the eastern boundary of the existing plant site.

Operation and maintenance costs at the Little Patuxent Water Reclamation Plant in fiscal year 2014 averaged \$1,820.33 per million gallons treated for an average flow of approximately 20.4 MGD. An additional 1.3 MGD from the Patuxent Basin was pumped to the Patapsco Basin via the Route 108 Pumping Station during this period.

The Patuxent Institute for Defective Delinquents and the Clifton T. Perkins Hospital are served by sewage collection and treatment systems owned and operated by the State of Maryland. The sewage collected at the Institute is pumped to the treatment facility at the Maryland House of Correction in Jessup. The Maryland Environmental Service has constructed improvements to the Jessup Plant. The Wholesale Food Market, a state property, is provided public sewerage service by Howard County.

Several properties along Dorsey Run Road were in need of public sewerage service. Providing service to these properties using Howard County's sewer system would require construction of a sewer pumping station. In a cooperative effort with Maryland Environmental Service and the Maryland Department of Public Safety and Correctional Services, an agreement was executed in September, 1992 to allow the properties along

Dorsey Road to use the nearby State sewer system, which would allow these properties to be provided gravity sewer service, eliminating the need for an expensive sewage pumping station. In exchange, Howard County agreed to construct a sewer line to divert the sewage from several State properties into the County's sewer system. By agreement, the flow diverted from the State properties to the County's sewer system will always be equal to or greater than the flow diverted from properties in the County to the State's sewer system. If necessary, the County also agreed to divert flows from the Patuxent Institute to the County's sewer system in order to maintain a balance in sewage flows diverted between the State and Howard County. Construction on this "Patuxent Diversion Sewer" has been completed, and the Patuxent Institute's flow has been diverted on a proportional basis to Howard County facilities.

Presently, there are six major interceptors flowing to the Little Patuxent Plant: the Hammond Branch, Little Patuxent, Middle Patuxent, Guilford Run, Patuxent and Dorsey Run Interceptors. The flows in the Patuxent Interceptor are pumped by the North Laurel Pump Station to the Hammond Branch Interceptor. The Hammond Branch Interceptor serves the Hammond Branch drainage basin from the Anne Arundel County boundary to Fulton. The Guilford Run Interceptor serves the area along Route 32 from Annapolis Junction to Guilford. The Guilford Interceptor also carries flows pumped from the Dorsey Run Interceptor. The Dorsey Run Interceptor serves the Greater Baltimore Food Market and vicinity and, the area parallel to and west of Route 175 from Jessup to Jonestown.

The Little Patuxent Interceptor, which extends from Savage northward to above Route 40, is the major contributor to the Little Patuxent Water Reclamation Plant. Flow in the Little Patuxent Interceptor above Route 108 can either flow by gravity downstream to the Little Patuxent Water Reclamation Plant or be diverted to the Patapsco service area by the Route 108 Pump Station. A force main from the pumping station carries the flow to the Cat Rock Run Interceptor, which is a tributary to the Patapsco Interceptor via the Tiber Branch connection. Howard County is currently allotted 15.1 MGD in the Patapsco Interceptor immediately downstream from the Tiber Branch connection, which is adequate through build-out to accommodate the Tiber Branch gravity flows plus the Rte. 108 Pumping Station flows. The Rte. 108 Pumping Station is used on an "as-needed" basis to reduce flows to the Little Patuxent Water Reclamation Plant during periods of construction or in order to reduce loadings. A capital project to upgrade the Rte. 108 SPS was completed, which included a new flow diversion structure adjacent to the station for balancing flows, new odor control facilities, and individual variable speed drive units on each pump.

The Middle Patuxent Interceptor connects to the Little Patuxent Interceptor north of Savage. The planned service area will include the area bounded approximately by Route 108 to the north and west, Md. Route 32 to the south, and the natural drainage fall line to the east. This encompasses the Village of River Hill and areas of Clarksville. A special sub-district of the Metropolitan District was established for properties served by the Middle Patuxent Interceptor to recover the construction cost of the interceptor, however the special construction charge was discontinued as the remaining funds are sufficient to pay off the bonds.

4.8 Deep Run Water Reclamation Plant

The Deep Run plant has been out of service and decommissioned since the mid 1980's. The plant is targeted for demolition.

4.9 Sanitary Sewer System Hydraulic Modeling for Capacity Evaluation

In order to determine capacity needs in the sanitary sewer conveyance system, the County uses a sanitary sewer hydraulic model that includes all interceptors 12-inch diameter and larger. There are two separate hydraulic models: one for the Little Patuxent drainage area and the other for the Patapsco drainage area. Each model has several different scenarios representing current and future flows and current and future piping.

Sewage flows were projected using data obtained from flow metering programs in 2001 and 2010 along with 2014 winter quarter water usage records and future population and land use projection information from the Howard County Department of Planning and Zoning (DPZ). Flows were developed at Years 2013 (current), 2015, 2020, 2025, 2030, 2035 and 2040, which is considered build-out. The DPZ data was comprised of projected population, commercial development and industrial development which were processed to develop corresponding flow projections.

For groundwater infiltration and rainfall-dependent infiltration and inflow (RDII), data from the March 12-14, 2010 heavy rainfall and snowmelt event (designated "Rainfall Event A") were used. Data from the County's as-built drawings were used in conjunction with pipe roughness coefficients developed from previous hydraulic modeling work and flow metering programs to create sewer pipe and manhole asset data such as pipe lengths, pipe diameters, invert elevations, grades, manhole depths, etc.

Year 2040 ultimate flow conditions were simulated in the XP-SWMM hydraulic model to identify those pipes with insufficient capacity and to determine the improvements

necessary to provide supplemental capacity. Sewer capacity was evaluated based on the County's goal of achieving a depth-to-diameter (d/D) ratio of 0.80 or less (i.e. 80% full based on depth) in all sewer pipes under design conditions. The construction of parallel sewer pipelines was used as a reliable "default" method to increase pipeline capacity, but other methods and technologies will be considered and evaluated as projects are developed.

The full set of recommended hydraulic improvements identified in **Table 13 – Immediate, 5-Year, 10-Year, and Comprehensive Priorities for Sewer System Development** and shown on **Figure 4-3: Immediate, 5-Year, 10-Year and Comprehensive Priorities for Water System Development** will achieve the capacity goals with only minimal exceptions such as inverted siphons. In order to prioritize the capacity improvements, the improvements were further evaluated to determine which portions of the ultimate improvements would prevent flooding/overflow even if it would result in pipes exceeding the goal of 0.80 d/D ratio. These capacity improvements are designated for implementation in the 0-to-5 year range.

Table 15A– Flow Analysis Table provides an abbreviated version of the hydraulic modeling results. Focusing on the bottom pipe segment of each major branch, it shows the peak flow rate and available capacity under current conditions and the peak flow rate and available capacity under future conditions with the improvements listed in Table 13 – Immediate, 5-Year, 10-Year, and Comprehensive Priorities for Sewer System Development implemented.

For those capacity improvements that are under construction, the hydraulic model was updated to include the planned improvements based on the contract award plans that will be supplanted by the as-built plans upon project completion. The capacity improvements currently under construction are as follows:

- Capital Project No. S-6189 : North Laurel Wastewater Pumping Station
- Capital Project No. S-6271: Furnace Ave Sewer and Deep Run Inverted Siphon Improvements

For those capacity improvements that are currently in the design phase, the hydraulic model continues to utilize the aforementioned "default" parallel pipeline method to increase capacity even though the design engineer may ultimately select alternative methods. However, data gathered during the design phase of the improvement projects that improve the accuracy of the model, including field-measured corrections of sewer sizes and pipe grades/inverts, were added to the model to more accurately simulate the existing system. The capacity improvement projects currently under design are as

follows:

Capital Project No. S-6280: Hammond Branch & Patuxent Interceptor Improvements

Capital Project No. S-6281: Dorsey Run & Guilford Run Interceptor Improvements

Capital Project No. S-6282: Bonnie Branch & Rockburn Branch Interceptor
Improvements

Capital Project No. S-6283: Tiber Branch & Sucker Branch Interceptor Improvements

Capital Project No. S-6284: Deep Run & Shallow Run Interceptor Improvements

Other factors that should be taken into consideration in order to determine the priority for capacity improvements beyond the 0-to-5 year range include the following:

1. Present Worth Analysis – Compare the cost of constructing the full set of ultimate improvements in the near term versus constructing the project in stages over a longer period.
2. System Hydraulics – Consider such factors as maintaining minimum allowable flow velocities; evaluating differences in pump or pipe sizes required for initial improvements versus long-range improvements, etc., which can be affected by when improvements come on-line.
3. System Reliability – Determine if existing facilities have defects, corrosion, or other factors that warrant making the improvements sooner rather than later so that the failing assets could be taken offline either for repair / rehabilitation or with all flow going to the improvements.
4. Construction & Permit Limitations – Determine if it is advantageous to construct all improvements at one time rather than stage construction over a longer period.

In terms of selecting pipe sizes and the location and limits of the proposed improvements, the capacity improvements indicated in Table 13– Immediate, 5-Year, 10-Year, and Comprehensive Priorities for Sewer System Development and shown on the SEWER FACILITIES PLAN Map (EXHIBIT 2) are solely for planning purposes. During design, the design engineer may consider other approaches including in-trench replacement of existing pipelines with enlarged pipe sizes, or expanding or contracting the limits of the capacity improvements based on specific, detailed site data acquired during the design phase.

4.10 Required Local System Improvements based on Capacity Evaluation

Patuxent Sewer Drainage Basin

In the Little Patuxent Water Reclamation Plant drainage basin, the improvements needed to provide adequate capacity for future flows are listed below for the tributary drainage areas.

A. Little Patuxent Sewer Drainage Basin- south of MD Route 108

Analysis of the Little Patuxent drainage basin shows that no further hydraulic capacity improvements are required through the year 2040. The recent completion of construction contracts under Capital Project No. S-6175– Little Patuxent Parallel Interceptor Sewer addressed the capacity needs along the main Little Patuxent Interceptor from the LPWRP to MD Route 108.

B. Route 108 Pumping Station Drainage Basin (Little Patuxent Sewer - north of MD Route 108)

Hydraulic improvements are needed in this drainage area. The improvements to the Little Patuxent Interceptor under Capital Project No. S-6274– Little Patuxent Parallel Sewer will extend from MD Route 108 upstream to the Red Hill Branch Interceptor to address hydraulic deficiencies.

The Planned Service Area for sewerage was expanded to add Parcel 11, consisting of 239.78 acres of the County’s Alpha Ridge landfill, to the sewer service area (refer to EXHIBIT 2, revision S-02). Sewerage service for the expanded area is available from the 16-inch diameter Little Patuxent I-70 Interceptor that was constructed under County contract no. 3692.

As described in Chapter 1, the Planned Service Area boundary was expanded to include approximately 221.1 acres of the historic Doughoregan property (refer to EXHIBIT 2, revision S-01), and twenty properties in the Marriottsville Road area of west Ellicott City and totaling 158.76 acres (refer to EXHIBIT 2, revision S-03) that lie within the Route 108 Pumping Station sewer drainage basin. The sewer flow projections for these areas are included in Tables 1B and 1C of Chapter 2. Based on current zoning densities and sewer flow projections, hydraulic analysis shows that the major sewer facilities (interceptor sewers 12-inch diameter and larger, sewage pumping stations and water

reclamation plants) are adequate for the increased sewer flows through the planning period.

1. Sewerage service for the expanded service area of the Doughoregan property (the Westmount subdivision) is available from the 12-inch diameter Little Patuxent Interceptor sewer constructed under County contract no. 179-S.
2. Sewerage service to the expanded service area of west Ellicott City near Marriottsville Road is available from the 16-inch diameter Albeth Heights sewer constructed under County contract no. 3447. County Capital Project S-6293 is planned to extend a collector sewer from the Albeth Heights sewer to Board of Education parcel 203 in west Ellicott City.
3. The capacity of local sewerage collection facilities and necessary improvements will require further evaluation as existing and proposed development plans are prepared.

C. Middle Patuxent Sewer Drainage Area

Analysis of the Middle Patuxent drainage area showed that no further hydraulic capacity improvements will be required through the year 2040.

As described in Chapter 1, the Planned Service Area boundary was expanded to include four properties comprising 90.33 acres in the Guilford Road area of Clarksville (refer to EXHIBIT 2, revision S-04) that lie within the Middle Patuxent sewer drainage area. The sewer flow projections for the area are included in Tables 1B and 1C of Chapter 2. Based on current zoning densities and sewer flow projections, hydraulic analysis shows that the major sewer facilities (interceptor sewers 12-inch diameter and larger, sewage pumping stations and water reclamation plants) are adequate for the increased sewer flow through the planning period. Sewer service for the expanded area is available from the 12-inch diameter Cricket Creek Interceptor sewer constructed under County contract no. 3096. The capacity of local sewerage collection facilities and the improvements necessary to accommodate the proposed development will require further evaluation as development plans are prepared.

D. Hammond Branch Sewer Drainage Area

Hydraulic improvements are needed in this drainage area. Additional capacity is needed on the Hammond Branch Interceptor between the two sets of inverted siphons and a

portion upstream of the inverted siphons, plus portions of the HB1A- branch.

Portions of the existing HB1A- branch have been improved by Cured-In-Place Pipe (CIPP) lining and pipe bursting but additional capacity is still needed. The HB1A-branch receives flow from the North Laurel Pumping Station, which will be replaced with a new pump station with greater capacity that is currently under construction. Improvements to the Hammond Branch Interceptor and side branches are being developed under Capital Project No. S-6280– Hammond/Patuxent Interceptor Improvements which is currently in design.

As described in Chapter 1, the Planned Service Area boundary was expanded to include approximately 91.25 acres of land in the Scaggsville Road area of Fulton (refer to EXHIBIT 2, revision S-05) that lie within the Hammond Branch sewer drainage area. The sewer flow projections for the area are included in Tables 1B and 1C of Chapter 2. Based on current zoning densities and sewer flow projections, hydraulic analysis shows that the major sewer facilities (interceptor sewers 12-inch diameter and larger, sewage pumping stations and water reclamation plants) will be adequate for the increased sewer flow through the planning period. Sewer service for the expanded area is available from the 16-inch and 12-inch diameter Western School Complex Interceptor sewer constructed under County contract no. 3506. The capacity of local sewerage collection facilities and the improvements necessary to accommodate the proposed development will require further evaluation as development plans are prepared.

E. North Laurel Sewer Drainage Area

Hydraulic improvements are needed in this area. Additional capacity is needed for the lower half of the Patuxent Interceptor. Previous hydraulic model evaluations identified the NL1A- (Naces Branch) and NL1AA branches for additional capacity but subsequent updates to the model resulted in their elimination. Improvements to the Patuxent Interceptor are being developed under Capital Project No. S-6280– Hammond/Patuxent Interceptor Improvements, which is currently in design.

F. Guilford Run Sewer Drainage Area

Analysis of the Guilford Run drainage area showed that no hydraulic improvements are needed. The previous hydraulic model evaluations identified the “GR1A-“ and “GR1B-“ branches for additional capacity but subsequent updates to the model resulted in their elimination.

G. Dorsey Run Sewer Drainage Area

Hydraulic improvements are needed in this area. Additional capacity is needed for approximately the lower one-third of the Dorsey Run Interceptor. In addition to the supplemental capacity needed, the lower portion of the existing Dorsey Run Interceptor needs to be re-configured to remove a nearly 180-degree bend in the existing interceptor that contributes to surcharging in the Dorsey Run Interceptor.

The previous hydraulic model evaluations identified other portions of the Dorsey Run Interceptor and the DO1A- branch for additional capacity but subsequent updates to the model resulted in their elimination. Improvements to the Patuxent Interceptor are being developed under Capital Project No. S-6281 – Dorsey/Guilford Interceptor Improvements, which is currently in design.

Patapsco Sewer Drainage Basin

In the Patapsco Wastewater Treatment Plant drainage basin, the improvements needed to provide adequate capacity for future flows are listed below for the tributary drainage areas.

H. Bonnie Branch and Rockburn Branch Sewer Drainage Area

Hydraulic improvements are needed in this drainage area south of Ellicott City. Additional capacity is needed for various segments of the Bonnie Branch Interceptor including the billing meter at the downstream end. The previous hydraulic model evaluations identified the full length of the Bonnie Branch Interceptor and the full length of the Rockburn Branch Interceptor for additional capacity but subsequent updates to the model resulted in the reduction of the Bonnie Branch Interceptor improvements and elimination of the Rockburn Branch improvements.

The planned reinstatement of the Kerger Road Pumping Station will divert flow away from the Rockburn Interceptor to the Shallow Run Interceptor, which resulted in the reduction of improvements. Improvements to the Bonnie Branch Interceptor will be developed under Capital Project No. S-6282– Bonnie/Rockburn Branch Interceptor Improvements.

I. Tiber Branch Sewer Drainage Area

Hydraulic improvements are needed in this drainage area that serves Ellicott City. Additional capacity is needed for much of the Tiber Branch Interceptor including the

billing meter at the downstream end and portions of the Cat Rock Run Interceptor (the PA1GB branch). The portions of the Tiber Branch Interceptor in need of additional capacity are the lower section, especially the billing meter, and the central portion.

The Route 108 Pumping Station is occasionally used to divert flow from the Little Patuxent Water Reclamation Plant drainage basin to the Patapsco Wastewater Treatment Plant drainage basin through the Cat Rock Run Interceptor. The improvements to the Cat Rock Run Interceptor are needed only for operation of the Route 108 Pumping Station. Improvements to the Tiber Branch Interceptor are being developed under Capital Project No. S-6283– Tiber/Sucker Branch Interceptor Improvements, which is currently in design. Improvements to the Cat Rock Run Interceptor will be developed under Capital Project No. S-6285– MD 108 Pump Station Outfall Improvements.

J. Sucker Branch Sewer Drainage Area

Hydraulic improvements are needed in this drainage area north of Ellicott City. Additional capacity is needed for various segments of the Sucker Branch Interceptor including the billing meter at the downstream end. Portions of the existing interceptor were paralleled under previous contracts; however, the earlier paralleling efforts did not encompass the full length of the interceptor. In some cases, the parallel sewer was not large enough to provide the full amount of capacity needed. As a result, supplemental capacity is needed for much of the length of the Sucker Branch Interceptor. Improvements to the Sucker Branch Interceptor are being developed under Capital Project No. S-6283– Tiber/Sucker Branch Interceptor Improvements, which is currently in design.

K. Deep Run Interceptor Sewer Drainage Area

Hydraulic improvements are needed in this drainage area in eastern Howard County. Additional capacity is needed for approximately the upstream half of the Deep Run Interceptor (“DR1—“) that is located upstream and west/northwest of the Anne Arundel County border. The downstream portion of the interceptor following along the Howard County/Anne Arundel County border has sufficient capacity. Improvements to the Deep Run Interceptor are being developed under Capital Project No. S-6284– Deep Run/Shallow Run Interceptor Improvements, which is currently in design.

Additional capacity is needed through the inverted siphon that conveys flow from the Deep Run Interceptor across the Patapsco River to the Patapsco Interceptor in Baltimore County. The capacity improvement is currently being addressed by construction of a

third siphon barrel under Capital Project No. S-6271– Furnace Avenue Sewer and Deep Run Inverted Siphon Improvements.

Improvements are currently being constructed for the area served by the Furnace Avenue sewer under Capital Project No. S-6271. The downstream portion is under construction but the upstream portion also requires additional capacity.

L. Shallow Run Sewer Drainage Basin

Hydraulic improvements are needed within the Shallow Run drainage area, which is part of the area served by the Deep Run Interceptor. Additional capacity is needed for the Shallow Run Interceptor. The previous hydraulic model evaluations identified fewer portions of the Shallow Run Interceptor for additional capacity but subsequent updates to the model expanded the portions in need of improvements.

The planned reinstatement of the Kerger Road Pumping Station will divert flow away from the Rockburn Interceptor to the Shallow Run Interceptor which resulted in the increased need for improvements. Improvements to the Shallow Run Interceptor are being developed under Capital Project No. S-6284– Deep Run/Shallow Run Interceptor Improvements, which is currently in design.

M. Sewage Pumping Station Improvements

In evaluating pumping stations for capacity, the pumps and the accompanying force mains are considered to comprise individual comprehensive systems. In other words, pumping stations that require additional capacity may require improvements to the force main as well as the pump station itself. For both the Little Patuxent Water Reclamation Plant drainage basin and the Patapsco Wastewater Treatment Plant drainage basin, the improvements to pumping stations that are needed to provide adequate capacity for future flows are listed below by individual pumping station.

North Laurel Sewage Pumping Station

The need for additional pumping capacity within the North Laurel Pumping Station is currently being addressed by construction of a new pumping station to replace the existing station. Improvements are currently being constructed under Capital Project No. S-6189– North Laurel Wastewater Pumping Station.

Dorsey Run Sewage Pumping Station

An updated analysis of hydraulic capacity showed that no hydraulic improvements are needed for the Dorsey Run station. Previous hydraulic modeling had

identified the need for additional pumping capacity but subsequent updates to the model determined that sufficient capacity currently exists.

Henkel's Lane/Annapolis Junction Sewage Pumping Station

Updated analysis determined that no hydraulic capacity improvements are required for this station.

US Route 40 Sewage Pumping Station

Updated analysis determined that no hydraulic capacity improvements are required for this station.

Rockburn Sewage Pumping Station

Updated analysis determined that no hydraulic capacity improvements are required for this station. The previous hydraulic model evaluations identified the Rockburn Pumping Station for additional capacity but subsequent updates to the model resulted in the elimination of the improvements. The planned reinstatement of the Kerger Road Pumping Station will divert flow away from the Rockburn Interceptor and the Rockburn Pumping Station to the Shallow Run Interceptor, which eliminated the need for additional capacity at the Rockburn pump station.

Kerger Road Sewage Pumping Station

Improvements to the Kerger Road Pumping Station are being developed under Capital Project No. S-6282– Bonnie/Rockburn Branch Interceptor Improvements, which is currently in design. The Kerger Road pump station will enable diversion of excess flow away from the Rockburn Interceptor and Rockburn Pumping Station to the Shallow Run Interceptor.

Meadowridge Road Sewage Pumping Station

No hydraulic capacity improvements are required for this station.

Old Landing Sewage Pumping Station

No hydraulic capacity improvements are required for this station.

4.11 Biosolids and Residual Solids Processing and Disposal

Biosolids and other residual solids are currently generated at the Little Patuxent Water Reclamation Plant by the removal of suspended and dissolved solids during the wastewater treatment processes, and by the collection of wastes from private septic systems and shared sewage disposal facilities throughout the County. Septic tank

biosolids are collected by private haulers and haulers under contract to the County who dispose of it for treatment at the Little Patuxent Plant.

Sewage biosolids are currently thickened at the Little Patuxent Water Reclamation Plant by dissolved air flotation and gravity thickening. The thickened biosolids are dewatered by centrifuge to a density of approximately 25 percent dry solids by weight. The dewatered biosolids are then alkaline (lime) stabilized or pasteurized to a Class A “exceptional quality” (EQ) product. The stabilized biosolids are then removed from the plant by a biosolids disposal contractor and applied in bulk as a soil amendment/fertilizer to agricultural fields, mostly in Maryland.

The reliability of a land application program for biosolids is dependent on the availability of application sites, which is in turn a function of landowner perception of the program, cropping practices, regulatory constraints, and the amount of undeveloped land available. Currently, this operation is contracted to a biosolids disposal contractor that is responsible for locating sites for land spreading the stabilized biosolids and obtaining the required permits for hauling, handling and application of the biosolids. The contractor may at its option haul biosolids to a landfill outside of Howard County for disposal.

In 2006, a comprehensive biosolids management study was completed for LPWRP. The study evaluated biosolids treatment and disposal options to identify the long term approach best suited for the Little Patuxent Plant and recommended continued reliance on land application with landfilling as a standby option. A biosolids processing train was constructed as part of the LPWRP Sixth Addition improvement project and consisted of gravity thickening of primary solids, flotation thickening of waste activated biosolids, blending of thickened solids, dewatering with centrifuges, and lime stabilization or pasteurization. The LPWRP Seventh Addition improvement project, completed in 2012, added a third centrifuge to augment two existing centrifuges.

Recent and emerging regulatory changes in Maryland that prohibit winter land application and may prohibit the continued application of biosolids on a large number of farm fields threaten the long-term sustainability and cost-effectiveness of current biosolids management practices. In order to address the uncertainty of the regulatory environment and the costs and operational demands associated with lime stabilization process, Howard County commissioned the preparation of a Biosolids Master Plan for the Little Patuxent Water Reclamation Plant in 2013. The 2013 Biosolids Master Plan recommended that the County shift from lime stabilization and land application of biosolids to Anaerobic Digestion and Heat Drying (AD+HD) to produce a versatile biosolids product with multiple and diverse end use markets.

Table 16 presents the estimated biosolids production and **Table 16A** provides a summary of the biosolid treatment and disposal information for the Little Patuxent Plant.

4.12 Reclaimed Water System

Howard County has taken initiatives to develop a reclaimed water distribution system to provide an alternative to the consumption of potable water for non-potable water uses, and to provide beneficial use for the high quality water discharged from the Little Patuxent Water Reclamation Plant.

In June 2014, Howard County completed the preparation of two planning documents for reclaimed water: the “Conceptual Reclaimed Water System Master Plan” and “Reclaimed Water Management (RWM) Plan”. The Conceptual Reclaimed Water System Master Plan provides a conceptual plan for development of the reclaimed water system including a conceptual layout and staging plan for the system. The Reclaimed Water Management (RWM) Plan is a supplement to the Master Plan and provides additional detail regarding reclaimed water production and treatment, transmission and distribution, market and customer development, monitoring and reporting, and public health and safety controls. The RWM Plan was produced in accordance with the standards and specifications of the Maryland Department of Environment as outlined in Chapter 7 of the proposed “Guidelines for Use of Reclaimed Water” and is included as EXHIBIT 11.

In addition to the Reclaimed Water Master and Management Plans, Capital Project W-8325: Reclaimed Water System Development was established by the County to develop a market for reclaimed water and to plan, design and construct a reclaimed water system to serve the eastern portion of the County with reclaimed water from the Little Patuxent Water Reclamation Plant. The capital project provides funding to extend a reclaimed water pipeline from the LPWRP to an existing 2.5 million gallon water storage tank that will be modified for use as a reclaimed water storage facility.

All reclaimed water utilized in Howard County is expected to be obtained from the high quality effluent produced by the Little Patuxent Water Reclamation Plant (LPWRP). The rated capacity of LPWRP is 29.0 mgd, however the current average daily flow is approximately 20 mgd, all of which is available for use as reclaimed water. Based on the standards established within the MDE “Guidelines for Use of Reclaimed Water”, the effluent discharge from LPWRP complies with the standards for Class IV water quality, which is suitable for all approved reclaimed water uses.

Howard County is currently in the process of implementing a reclaimed water system in association with Fort Meade in Anne Arundel County to reduce the Fort’s dependency on

groundwater for non-potable water use. The Fort Meade reclaimed water system is a 5.0 MGD facility consisting of an outfall diversion structure, pumping station, an elevated storage tank and a reclaimed water distribution system for the Fort George Meade east campus expansion. The project will reduce Fort Meade's dependency on groundwater from a hydraulically stressed aquifer. The system is projected to utilize 1.62 MGD of reclaimed water obtained from the effluent pipeline of the Little Patuxent Water Reclamation Plant (LPWRP) starting in 2015, and gradually increase withdrawals from the pipeline to approximately 5.0 mgd by 2025. The NPDES permit for the LPWRP was modified to incorporate this system as another outfall (Discharge Point 102- Reclaimed Water Pumping Station) which includes monitoring and reporting the flow through the monthly Discharge Monitoring Reports (DMR's).

Several other commercial entities including Dreyer's Grand Ice Cream, Inc. and Laurel Sand and Gravel, Inc. have expressed mild interest in the potential use of reclaimed water but have not proceeded with plans to facilitate connection to the system.

4.13 Septage Collection and Treatment

Fourteen percent of the population of Howard County comprising approximately 13,560 households and a small number of businesses within and outside of the Planned Sewer Service Area utilize private on-site septic systems or shared sewage disposal facilities for sewage treatment. These systems utilize septic tanks and holding tanks to collect and separate the settleable and floating solids from the liquid waste and retain the waste for eventual removal and disposal at a septage receiving facility.

Septic tanks require periodic cleaning and maintenance to maintain optimum performance of the soil treatment system. The usual procedure is to pump out the entire contents of the tank each time the tank is cleaned out. The quantity of septage produced by each unit is affected by the number of persons served by the unit, waste characteristics and volume, the size of the septic tank unit and the cleaning frequency. Using a typical value of 100 gallons of septage waste production per person per year, the total volume of septage waste generated annually and stored within septic tanks in Howard County is estimated as follows:

Year 2015: 43,947 persons x 100 gals/year = 4.4 million gallons/year

Year 2040: 50,918 persons x 100 gals/year = 5.1 million gallons/year

The sole designated location for disposal of septage waste in Howard County is the Little Patuxent Water Reclamation Plant. The County's primary objectives for receiving

hauled wastes are to (1) prevent illegal dumping, and (2) provide a service for County residents in rural areas and County businesses.

Comprehensive administrative and operational controls have been in place for several years to manage septage waste at this facility. Septage haulers desiring to discharge collected waste at the plant must obtain both an operating permit from the Howard County Health Department as well as a discharge permit from the treatment plant. The discharge permit specifies rules and conditions which must be satisfied by the septage hauler to retain permission to discharge at the plant. Haulers must maintain records of customers serviced, maintain their equipment in good operating condition, follow certain operational procedures while on the plant site, and provide the County with a Surety (bond, deposit, etc.) that can be applied against any overdue charges or damages.

In February 2013, Howard County completed construction of a Septage Acceptance Plant (SAP) and Aerobic Digester (AD) for grease pretreatment within the Little Patuxent Water Reclamation Plant. Prior to construction of the SAP and AD, waste haulers dumped their wastes into an influent manhole at the plant and weighed their trucks before and after discharging to determine the amount of waste discharged. The plant experienced operational and maintenance problems including excessive fouling of equipment resulting from grease accumulation at various locations in the plant. Following construction and implementation of the pretreatment facilities including the SAP and AD processes, the negative impacts of receiving hauled waste have been reduced.

A. Historical Loadings at the LPWRP Septage Receiving Facility

Waste collected by septage haulers consists of several types. The predominant waste type is that collected from residential septic tanks. In addition, grease traps at food preparation facilities, holding tanks, and a limited amount of commercial/industrial waste are collected by septage haulers. Industrial wastes may not be discharged at County receiving facilities unless that waste complies with adopted local as well as applicable Federal pretreatment standards.

A sampling program was implemented to collect random samples of delivered septage waste. Collected samples are routinely analyzed for parameters which will establish the strength of the waste loads. Specifically, samples are analyzed for BOD, Suspended Solids and Total Phosphorous since these parameters are critical in defining the waste strength for assessment of high strength charges. Loads are also periodically sampled to test for other pollutants such as heavy metals. Samples may be collected of any load which appears to be industrial in nature. Haulers of industrial waste are required to

obtain prior permission from the treatment plant prior to discharge. If such permission is not obtained and a load is delivered for disposal, that load may be visually inspected and sampled to insure pretreatment standards compliance.

The County maintains records of the high, low, and industrial strength wastes received to help in the billing process of septage receiving. In 2011, the LPWRP received a total of 9,800,000 gallons of hauled waste from 14 different waste haulers. Of the total waste received that year, 81% was defined as low strength waste (7.9 million gallons), 18% was designated high strength wastes (1.8 million gallons) and 1% was industrial waste (51,000 gallons). All of the industrial flow received in 2011 was from a single waste hauler.

In 2012, the total gallons of hauled waste received increased by approximately 17%, with a total of 11.4 million gallons of hauled waste received that year. The facility again received waste from 14 different haulers; however, the haulers were not all the same haulers that discharged in 2011.

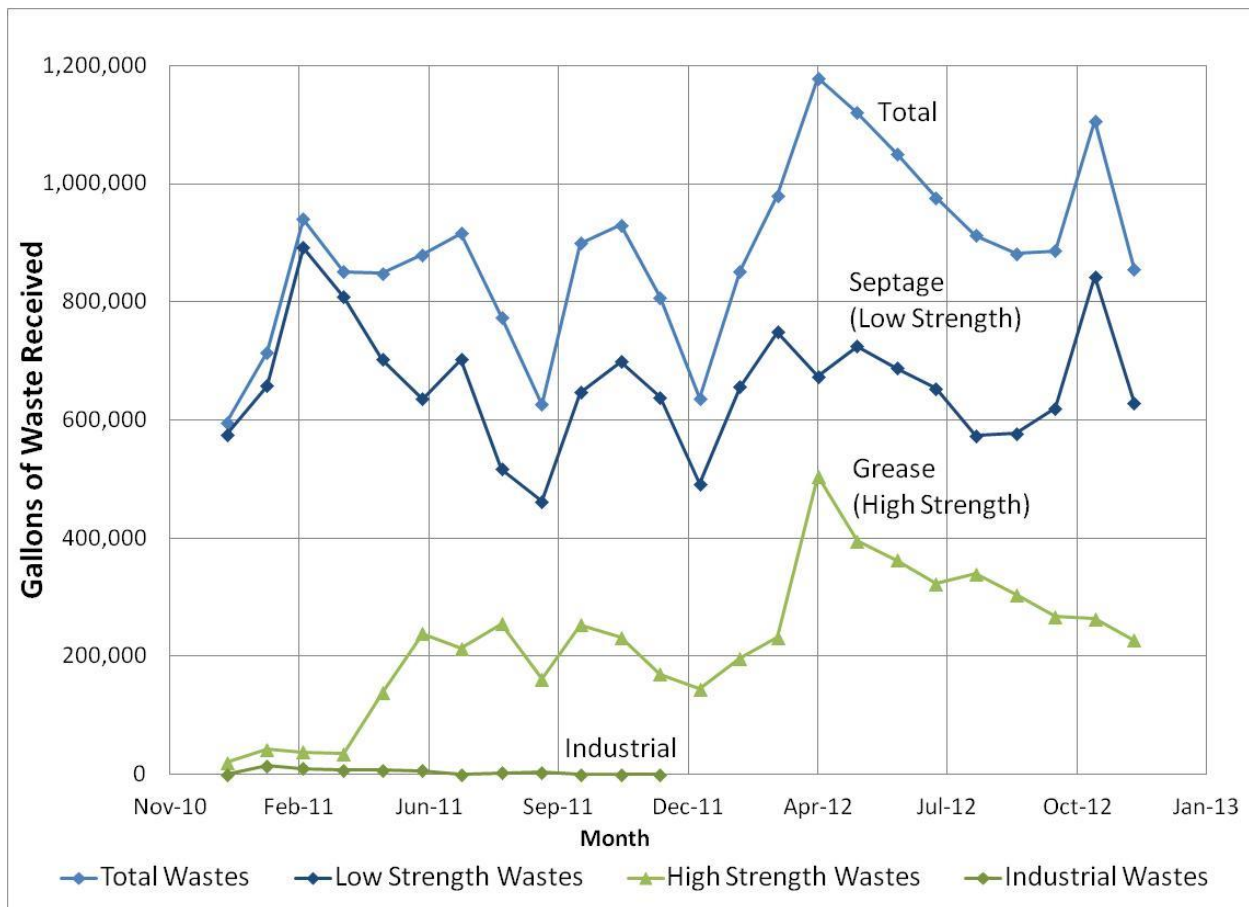

Source: Septage Receiving Fee Study by O'Brien & Gere, September 2013

While the overall total increased in 2012, the volume of septage (i.e., low strength waste) received in 2012 remained fairly similar (1% difference) to the volume of septage received in 2011. In addition, no industrial wastes were discharged in 2012. The increase in overall gallons received was due to an increase in high strength wastes, which was almost double the volume received in 2011.

From 2011 to 2012, the LPWRP received an average of 10,609,944 gallons of hauled waste per year, or approximately 29,000 gallons per day (GPD). During the monitoring period, approximately 75% of the received hauled waste was low strength and the remaining 25% was high strength waste.

B. Anticipated Loadings

Overall, the total septage and grease received at LPWRP increased through the time period reviewed (2011-2012). Despite the overall increase, the data suggested that the overall increase really corresponded to the overall increase in grease received through the time period reviewed. There did not appear to be a specific seasonal trend; the loadings varied year-to-year and season-to-season. Despite the overall increase in grease, there was also a recent downward trend, beginning in April 2012 that started to show the volume of grease received returning to lower volumes. Despite these fluctuations, the amount of low strength or septage waste through the time period appeared to remain fairly stable.

While the County experienced a downturn in grease reception in 2012, it is noteworthy that WSSC announced that it will stop receiving wastes from outside of the Blue Plains service area (Prince George's County, Montgomery County, Fairfax County and Loudon County). The outside haulers that hauled septage to WSSC facilities will need a new station to discharge and may come to Howard County to do so, if permitted, which will increase the grease received. This may offset the recent downturn in numbers.

Septage or low-strength waste reception seems steady; however, WSSC's recent change in septage origin policy may initiate additional grease loadings at LPWRP.

4.14 Financing Sewerage Improvements

The Department of Public Works assumed the functions of the Howard County Metropolitan Commission when the County Charter was adopted in 1968. Under the

Charter and existing local public laws, the following charges are authorized to finance the construction, operation, maintenance and administration of sewerage facilities:

1. Ad Valorem Assessment
2. Front Foot Benefit Assessment
3. In-Aid-of-Construction Charge
4. Sewer House Connection Fees
5. Sewer User Charges and Surcharges
6. Reclaimed Water User Charges
7. Operation and Maintenance Fee, Shared Sewage Disposal Facilities
8. Other Sources of Sewerage System Funds

A. Ad Valorem Assessment

A yearly levy of \$0.08 per \$100 of assessed property value is made against all properties within the Metropolitan District. The assessment is a source of revenue designated to cover the cost of retiring bonds issued by the County and can be used to cover the payment of salaries and other expenses of the Department of Public Works related to the water and sewerage systems.

B. Front Foot Benefit Assessment

The front foot benefit assessment is levied against all properties provided with sewer service and the revenue is used for bond debt service. The residential front foot assessment rate for FY2015 (July 1, 2014-June 30, 2015) is \$1.13 per foot for the first 150 feet, \$0.85 for the next 150 feet, and \$0.42 per foot for additional footage. The commercial front foot assessment rate for sewer service is \$1.41 per foot of total frontage. Front Foot Benefit Assessments are no longer applied to capital projects funded after FY2005.

C. Sewer In-Aid-of-Construction Charge (Sewer IACC)

This fee is applicable to all users of the sewer system and is a source of revenue designated to cover the cost to Howard County of construction or purchase of public sewer facilities which serve or will serve all properties connected to the system, whether or not these facilities are located in the County. The fee structure was modified for Fiscal Year 2012, and is now a one-time charge based on the size of the water meter, with additional fees collected if a change in meter size is required. The current fee structure is tabulated as follows:

<u>Size of Water Meter</u>	<u>Sewer IACC Fee (FY2015)</u>
5/8 – 1”	\$600
1 ½”	\$4800
2”	\$7680
3”	\$16,800
4”	\$28,800
6”	\$64,800
8”	\$230,400
10”	\$336,000
12”	\$422,400

The above charges, fees, and assessments are reviewed and readopted annually by the County Council with appropriate changes.

D. Sewer House Connection Fees

After June 30, 2007, individual residential connections to the public sewer system are performed by Howard County licensed on-site utility contractors under contract with the property owner. The County charges a \$300 inspection and administration fee and holds a 10% retainer based on the estimated construction cost. Under special circumstances as approved by the Director of Public Works, a one-time charge may be used for connections to the public sewer system that are constructed under Howard County capital projects. This charge covers the construction of the connection from the sewer lines in the public right-of-way to the abutting property line of the property served. Under these special circumstances, an individual homeowner is charged \$4500 for a 4 inch sewer connection to a residential property. Connections larger than 4-inches and sewer connections for commercial properties will continue to be performed by the Advanced Deposit Order (ADO) process.

E. Sewer User Charges and Surcharges

Metered water consumption is the basis for the sewer user charge. The sewer user charge rate for FY 15 is \$3.10 per unit (1 unit = 100 cubic feet), and a quarterly account user charge of \$11.13. A flat rate of \$81.23/quarter is charged to customers with sewer service but no water service. Additional surcharges are charged to non-residential sewer system users discharging wastes which exceed established concentration limits for BOD, suspended solids and phosphorus. Revenues collected recover costs incurred in the

operation and maintenance of the sewerage system by the jurisdictions collecting and treating the flows generated.

F. Reclaimed Water User Charges

Since reclaimed water is a byproduct of the wastewater treatment process, there is no cost for supply. However there is the cost for initial construction of the distribution system and operation & maintenance. Initial construction of reclaimed water facilities will be funded through bonds. User fees based on the amount of reclaimed water used and ad valorem charges will be used to retire bonds and for normal operation & maintenance. Reclaimed water user rates are established on a volumetric basis. The FY 15 rates are as follows:

Volumetric Rate	\$1.22/ 100 cu ft.	
Quarterly Account User Fee	5/8"-1" meter	\$ 14.57
	1 1/2" – 3" meter	\$ 47.04
	4" and over	\$ 239.20

G. Operation and Maintenance Fee, Shared Sewage Disposal Systems

The owner of each lot connected to a shared sewage disposal system (SSDS) shall pay the County an annual fee for the operation and maintenance of the facility. The fee consists of three funds:

- (1) a fund for the routine operation and maintenance of the SSDS
- (2) a replacement fund for the expected replacement of the SSDS
- (3) an insurance fund to cover unplanned major replacement costs

User fees are based upon the projected yearly operation and maintenance costs for each type of system. In FY15, users of systems that operate with a MDE issued discharge permit have an annual charge of \$1,100 per year, users of systems without a permit have an annual charge of \$535 per year and users of the Sheppard Manor system have an annual charge of \$6,000 per year.

H. Other Sources of Sewerage System Funds

In addition to fees and charges to property owners as sources of construction revenue, the County has the following sources of funds:

- 1. Federal Grants
- 2. State Assistance

3. Chesapeake Bay Restoration Fund
 4. Developer Agreements
 5. Interest Income
- State Assistance - In response to the 1987 Clean Water Act the Maryland Water Quality Revolving Loan Fund was created. The Fund is being capitalized primarily by Federal grants and matching funds from the State. The Fund is used to finance loans to local governments for municipal wastewater treatment projects and other water quality projects such as sewer interceptor construction and rehabilitation. Loans made to local governments must be paid back in full, but interest rates charged on the loans are at below market interest rates. In addition, the Water Quality Financing Administration, with monies provided under the Bay Restoration Fund Act, provides grant funding for Enhanced Nutrient Removal (ENR) upgrades to existing treatment facilities. The seventh addition to the LPWRP has qualified for grant funding for its ENR portion of the upgrade.
 - Developer Agreements - The Developer Agreement is a method for financing the construction of collector sewers and shared waste disposal facilities in new subdivisions. For collector sewers the developer advances the total system construction cost including engineering and administrative expenses. Prior to 2005, after connection to the system, the developer was rebated for each single-family detached residential lot fronting on and served by the sewer line constructed under the Developer Agreement, and may have recovered up to 100% of the construction costs. Rebates varied for other types of residential, commercial and industrial properties. For shared waste disposal facilities, the developer posts security guaranteeing the construction and warranty of the facilities. No rebates are applicable. After 2005, the Developer rebate program was ended for all new subdivisions, and the developer can recover his construction costs through the price of the lot or through creation of a private water company (under Maryland State Law) to bill the costs through the users.

Refunds for major sewer facilities are covered by separate Developer Major Facility Agreements. Refunds are paid to the developer based on connections by properties served by the major sewer facilities. These refunds may be based on the In-Aid-of-Construction charges collected for each connection or a percentage of ad valorem taxes collected for properties served by the facility or any combination of these. The maximum refund paid to the developer shall not exceed 100% of the project construction cost. Agreements for major facilities are effective for 10 years after which no further refunds are paid to the developer.

- Interest Income - Proceeds from bonds and revenues earmarked for construction are invested and earn interest until they are needed. Due to the irregularity of disbursements and receipts, annual interest income varies considerably.

4.15 Financial Management Plan

The Department of Public Works is responsible for operating and maintaining all public sewer facilities in Howard County. A Water and Sewer Enterprise Fund was established to provide the funding mechanism for the operation and maintenance of the public sewer system as well as to provide financing for the retirement of debt incurred for the construction of the sewer system. This Fund is financed through the use of user charges, front foot benefit and ad valorem assessments, connection fees, in-aid-of-construction fees, and other revenue sources as shown in Schedule FS - Financial Management Statistics. Schedule FS- Financial Management Statistics provides a summary of the expenses incurred and revenues received by the County's Water and Sewer Fund for Fiscal Years 2012, 2013 and 2014.

In addition, the portion of Howard County in the Patapsco sewer service area is provided wastewater treatment services by Baltimore City at the Patapsco Wastewater Treatment Plant. Sewage from Howard County must first flow through the Patapsco Interceptor in Baltimore County before reaching the Patapsco Wastewater Treatment Plant. Howard County has several sewer service agreements with Baltimore County which provide the mechanism for Howard County to pay for these wastewater conveyance and treatment services. Baltimore County, in turn, has similar agreements with Baltimore City.

SCHEDULE FS
 FINANCIAL MANAGEMENT STATISTICS
COUNTY WATER & SEWER PLANS

County Name: Howard
 System Name: Patuxent/Patapsco

Fiscal Year # 1 FY12
 Fiscal Year #2 FY13
 Fiscal Year #3 FY14

A: FISCAL YEAR (Combined W&S)	FY 12	FY 13	FY 14
B: User (W&S) Charge Revenue	\$44,415,649	\$47,540,099	\$52,558,292
C: Misc Sales	\$3,234,841	\$4,325,626	\$4,742,596
D: Total Operating Revenue	\$47,650,490	\$51,865,725	\$57,300,888
E: Other Revenue (see page 2)	\$32,549,816	\$31,768,153	\$31,656,579
F: Total Revenue	\$80,200,306	\$83,633,878	\$82,957,467
G: Operations Expense	\$8,639,533	\$8,902,114	\$9,347,249
H: Maintenance Expense	\$8,639,533	\$8,902,114	\$9,347,249
I: Replacement Expense	\$8,639,534	\$8,902,115	\$9,347,250
J: Fees Paid to Other Jurisdictions	\$19,614,655	\$19,901,479	\$23,242,984
K: Total O,M & R (1)	\$45,533,255	\$46,607,822	\$51,284,733
L: Interest Expense (2)	\$8,189,329	\$8,891,733	\$9,185,598
M: Depreciation Expense	\$14,210,826	\$18,300,074	\$18,981,709
N: Total Expense	\$67,933,390	\$73,799,579	\$79,452,040
O: Debt Interest	\$109,427,770	\$114,621,216	\$115,604,931
P: Debt Principal (2)	\$230,582,942	\$247,620,116	\$306,860,789
Q: Total Flow Volume, MG (combined W&S)	18,141	17,812	18,323

Source: Comprehensive Annual Financial Report (CAFR)

R: Extraordinary repairs and maintenance are those that are of such nature as to be beyond those in the annual budget. Examples of “extraordinary” breakdowns may include failure of a blower in the aeration system, large pump system motor and control failure, clarifier sludge scraper arm and bearing failures, etc. Please identify the most costly potential repair and maintenance problem for this sewage system.

Sewerage System: Howard County operates only one wastewater treatment, the Little Patuxent Water Reclamation Plant in Savage, MD. The plant has a design capacity of 29.0 Million Gallons per Day and provides enhanced biological nutrient removal and treatment (ENR). Due to the numerous and complex interrelated treatment systems, it is not practical to identify one item as the single most costly repair and maintenance problem.

Water Supply System: Howard County purchases 100% of its water from Baltimore City and the Washington Suburban Sanitary Commission.

S: Approximate cost of (extraordinary) repair: Up to \$100,000 per event.

T: Describe the source of funds to cover this extraordinary item (a bond, line of credit, escrow account, working capital, etc.)

The cost of these unplanned expenses are covered by surpluses contained in the existing budget.

U: Additional comments:

Due to the nature of the budget process in Howard County, it is not feasible to precisely separate all revenues and expenses incurred during operation of the County’s public water system from those associated with operation of the public sewer system. Therefore, for the purposes of this report, combined revenues and expenses have been shown equally based on the cost of operation, maintenance and replacement for the County public water and sewer systems.

V: Detail of other revenue on line E (if applicable)

Non-Operating Revenues	Year 2012	Year 2013	Year 2014
	Amount	Amount	Amount
Ad Valorem	\$29,880,497	\$29,006,605	\$29,196,783
Interest on Investment	\$140,567	\$146,756	\$132,869
Other	\$(318,913)	\$(33,059)	\$71,879
Water/Sewer Assessment Charges	\$2,757,412	\$2,760,499	\$2,420,937
Interest Expenses	\$(8,189,329)	\$(8,891,733)	\$9,185,598)
TOTAL	\$24,270,234	\$22,989,068	\$22,636,870

Capacity (water) 41.5 MGD;
(sewer) 41.4 MGD

Users (2014) Residential: 71,000 accounts
Commercial: 4,042 accounts

User Rates & Fees (2014)

Water (a) Winter rate= \$1.93 per 100 cu. ft.
(b) Summer rate= \$2.15 per 100 cu. ft.

Wastewater rate= \$3.10 per 100 cu. ft.

Contact Person Name: Jeffrey K. Welty
Address: Howard County, Bureau of Utilities
8250 Old Montgomery Road
Columbia, MD 21045
Telephone: 410-313-4900

CHAPTER 4

TABLES AND FIGURES

**TABLE 9
PROJECTED SEWER FLOWS & CAPACITIES**

Sewer Drainage Basin	Household Population			Average Flow (MGD)		Available or Planned Treatment Capacity (MGD)
	Total	Unserviced	Served			
2015						
NPS & AR	43,947	43,947	0			0.00
Patuxent	148,454	0	148,454	17.87	22.09	29.00
Rt 108 SPS	39,632	0	39,632	4.22		
Patapsco	74,572	0	74,572	5.48		12.40
TOTAL	306,606	43,947	262,658	27.57		41.40
2020						
NPS & AR	45,232	45,232	0			0.00
Patuxent	157,124	0	157,124	18.82	23.52	29.00
Rt 108 SPS	43,473	0	43,473	4.71		
Patapsco	83,970	0	83,970	6.00		12.40
TOTAL	329,800	45,232	284,568	29.53		41.40
2025						
NPS & AR	46,319	46,319	0			0.00
Patuxent	163,372	0	163,372	19.44	24.50	29.00
Rt 108 SPS	45,824	0	45,824	5.06		
Patapsco	88,534	0	88,534	6.38		12.40
TOTAL	344,048	46,319	297,729	30.88		41.40
2030						
NPS & AR	47,856	47,856	0			0.00
Patuxent	168,852	0	168,852	20.10	25.33	29.00
Rt 108 SPS	46,764	0	46,764	5.23		
Patapsco	91,158	0	91,158	6.59		12.40
TOTAL	354,630	47,856	306,774	31.91		41.40
2035						
NPS & AR	49,381	49,381	0			0.00
Patuxent	172,557	0	172,557	20.48	25.72	29.00
Rt 108 SPS	46,776	0	46,776	5.24		
Patapsco	92,320	0	92,320	6.68		12.40
TOTAL	361,034	49,381	311,653	32.40		41.40
2040						
NPS & AR	50,918	50,918	0			0.00
Patuxent	173,796	0	173,796	20.62	25.85	29.00
Rt 108 SPS	46,776	0	46,776	5.24		
Patapsco	92,399	0	92,399	6.73		12.40
TOTAL	363,890	50,918	312,972	32.58		41.40

NPS = No Planned Service Area

AR = Alpha Ridge Water Service Area (No Planned Sewer Service)

**TABLE 9A
FLOW PROJECTIONS BY DRAINAGE AREA (MGD)**

2015

Location Code	Subdrainage Area	Population Served	Average Residential Flow ¹	Industrial Commercial Acres	Average Industrial Commercial Flow ²	Average I&I Flow ³	Total Average Flow
DR	DORSEY RUN PUMPING STATION	9,759	0.59	1,441	0.70	0.51	1.80
GR1	GUILFORD RUN (LP WRP)	189	0.01	489	0.64	0.26	0.91
GR2	GUILFORD RUN (ANNAPOLIS)	6,493	0.35	716	0.23	0.23	0.81
HB1	HAMMOND BRANCH	0	0.00	73	0.01	0.01	0.02
HB2	HAMMOND BRANCH	17,214	1.39	264	0.43	0.72	2.54
HB3	HAMMOND BRANCH	1,554	0.13	93	0.35	0.19	0.68
LP1	LITTLE PATUXENT	3,777	0.19	173	0.04	0.09	0.33
LP2	LITTLE PATUXENT	68,230	3.73	1,414	1.15	1.94	6.82
MP	MIDDLE PATUXENT	29,608	1.73	666	0.39	0.84	2.96
NL1	NORTH LAUREL PUMPING	11,630	0.65	144	0.08	0.29	1.02
PS1	RT 108 PUMPING STATION	39,632	2.71	388	0.30	1.20	4.22
	Total Patuxent	188,087	11.47	5,860	4.33	6.29	22.09
BB1	BONNIE BRANCH (METER)	6,595	0.40	10	0.03	0.06	0.49
BB2	BONNIE BRANCH (ROCKBURN)	2,083	0.10	0	0.00	0.02	0.12
D	DANIELS AREA	1,616	0.09	15	0.00	0.01	0.11
DP1	DEEP RUN	2,819	0.16	408	0.30	0.07	0.53
DP2	DEEP RUN	2,664	0.15	73	0.04	0.03	0.22
DP3	DEEP RUN	5,104	0.26	263	0.04	0.05	0.35
DP5	DEEP RUN	8,629	0.53	524	0.15	0.10	0.78
DP8	DEEP RUN	328	0.02	375	0.05	0.01	0.07
DP11	DEEP RUN	19,147	0.59	128	0.10	0.10	0.80
EC	ELLCOTT CITY	9,079	0.46	150	0.17	0.10	0.73
RB	ROCKBURN BRANCH	2,293	0.10	0	0.00	0.02	0.12
SB1	SUCKER BRANCH	5,956	0.39	22	0.03	0.06	0.48
SB2	SUCKER BRANCH	8,258	0.47	131	0.12	0.09	0.68
	Total Patapsco	74,572	3.72	2,100	1.05	0.71	5.48
	Total in PSA	262,658	15.19	7,960	5.38	7.00	27.57

2020

Location Code	Subdrainage Area	Population Served	Average Residential Flow ¹	Industrial Commercial Acres	Average Industrial Commercial Flow ²	Average I&I Flow ³	Total Average Flow
DR	DORSEY RUN PUMPING STATION	10,212	0.61	1,487	0.73	0.53	1.87
GR1	GUILFORD RUN (LP WRP)	757	0.04	496	0.64	0.27	0.95
GR2	GUILFORD RUN (ANNAPOLIS)	6,644	0.35	736	0.25	0.24	0.84
HB1	HAMMOND BRANCH	0	0.00	75	0.02	0.01	0.02
HB2	HAMMOND BRANCH	18,474	1.46	354	0.50	0.78	2.74
HB3	HAMMOND BRANCH	1,573	0.13	93	0.35	0.19	0.68
LP1	LITTLE PATUXENT	3,818	0.19	176	0.04	0.10	0.33
LP2	LITTLE PATUXENT	70,772	3.88	1,450	1.17	2.01	7.07
MP	MIDDLE PATUXENT	30,929	1.80	712	0.42	0.88	3.11
NL1	NORTH LAUREL PUMPING	13,946	0.77	155	0.09	0.34	1.20
PS1	RT 108 PUMPING STATION	43,473	3.02	431	0.35	1.34	4.71
	Total Patuxent	200,598	12.27	6,166	4.56	6.70	23.52
BB1	BONNIE BRANCH (METER)	7,050	0.42	10	0.03	0.07	0.52
BB2	BONNIE BRANCH (ROCKBURN)	2,087	0.10	0	0.00	0.02	0.12
D	DANIELS AREA	1,690	0.10	15	0.00	0.01	0.11
DP1	DEEP RUN	5,388	0.30	445	0.32	0.09	0.72
DP2	DEEP RUN	2,965	0.17	74	0.04	0.03	0.24
DP3	DEEP RUN	5,179	0.27	271	0.05	0.05	0.36
DP5	DEEP RUN	8,837	0.54	559	0.18	0.11	0.82
DP8	DEEP RUN	756	0.04	423	0.07	0.02	0.13
DP11	DEEP RUN	22,719	0.63	131	0.11	0.11	0.85
EC	ELLCOTT CITY	9,190	0.47	150	0.17	0.10	0.74
RB	ROCKBURN BRANCH	2,548	0.11	0	0.00	0.02	0.13
SB1	SUCKER BRANCH	6,121	0.40	25	0.04	0.06	0.50
SB2	SUCKER BRANCH	9,439	0.53	147	0.13	0.10	0.77
	Total Patapsco	83,970	4.08	2,250	1.14	0.78	6.00
	Total in PSA	284,568	16.34	8,416	5.70	7.48	29.53

Notes:

1. Ave Residential Flow (gcpd) is based on existing residential use summarized by flow meter drainage area and DPZ population projections.
2. Ave Industrial Commercial Flow is based on existing use plus the incremental acreage provided by DPZ multiplied by
3. I/I Contribution is based on the Allocation Report comparison of metered flows versus billed water usage as follows:

PATUXENT = 72% of Total Average Flow attributed to Water Usage
PATAPSCO = 87% of Total Average Flow attributed to Water Usage

**TABLE 9A
FLOW PROJECTIONS BY DRAINAGE AREA (MGD)**

2025

Location Code	Subdrainage Area	Population Served	Average Residential Flow ¹	Industrial Commercial Acres	Average Industrial Commercial Flow ²	Average I&I Flow ³	Total Average Flow
DR	DORSEY RUN PUMPING	11,289	0.67	1,542	0.76	0.57	2.00
GR1	GUILFORD RUN (LP WRP)	750	0.04	510	0.65	0.27	0.96
GR2	GUILFORD RUN	6,819	0.36	745	0.25	0.24	0.86
HB1	HAMMOND BRANCH	0	0.00	75	0.02	0.01	0.02
HB2	HAMMOND BRANCH	19,792	1.53	377	0.52	0.82	2.86
HB3	HAMMOND BRANCH	1,684	0.17	94	0.36	0.21	0.73
LP1	LITTLE PATUXENT	3,868	0.20	176	0.04	0.10	0.34
LP2	LITTLE PATUXENT	72,885	4.01	1,452	1.18	2.06	7.25
MP	MIDDLE PATUXENT	31,456	1.83	724	0.43	0.90	3.16
NL1	NORTH LAUREL PUMPING	14,829	0.80	163	0.09	0.36	1.25
PS1	RT 108 PUMPING STATION	45,824	3.23	466	0.38	1.44	5.06
	Total Patuxent	209,195	12.85	6,325	4.68	6.97	24.50
BB1	BONNIE BRANCH (METER)	7,683	0.45	10	0.03	0.07	0.55
BB2	BONNIE BRANCH	2,100	0.10	0	0.00	0.02	0.12
D	DANIELS AREA	1,889	0.11	15	0.00	0.02	0.13
DP1	DEEP RUN	5,509	0.33	464	0.33	0.10	0.77
DP2	DEEP RUN	3,787	0.21	76	0.04	0.04	0.29
DP3	DEEP RUN	5,381	0.28	289	0.06	0.05	0.39
DP5	DEEP RUN	9,243	0.58	572	0.18	0.11	0.88
DP8	DEEP RUN	1,158	0.06	445	0.08	0.02	0.16
DP11	DEEP RUN	23,231	0.66	157	0.13	0.12	0.91
EC	ELLCOTT CITY	9,403	0.48	150	0.17	0.10	0.75
RB	ROCKBURN BRANCH	3,150	0.13	0	0.00	0.02	0.15
SB1	SUCKER BRANCH	6,281	0.40	25	0.04	0.07	0.51
SB2	SUCKER BRANCH	9,722	0.55	147	0.13	0.10	0.78
	Total Patapsco	88,534	4.34	2,351	1.20	0.83	6.38
	Total in PSA	297,729	17.19	8,675	5.88	7.81	30.88

2030

Location Code	Subdrainage Area	Population Served	Average Residential Flow ¹	Industrial Commercial Acres	Average Industrial Commercial Flow ²	Average I&I Flow ³	Total Average Flow
DR	DORSEY RUN PUMPING	12,290	0.73	1,566	0.77	0.60	2.10
GR1	GUILFORD RUN (LP WRP)	750	0.04	512	0.65	0.27	0.97
GR2	GUILFORD RUN	6,837	0.36	760	0.26	0.25	0.87
HB1	HAMMOND BRANCH	0	0.00	86	0.02	0.01	0.03
HB2	HAMMOND BRANCH	20,478	1.57	430	0.55	0.84	2.97
HB3	HAMMOND BRANCH	1,684	0.21	100	0.39	0.24	0.84
LP1	LITTLE PATUXENT	3,875	0.20	177	0.05	0.10	0.34
LP2	LITTLE PATUXENT	75,667	4.17	1,452	1.18	2.13	7.47
MP	MIDDLE PATUXENT	31,656	1.84	774	0.47	0.92	3.23
NL1	NORTH LAUREL PUMPING	15,615	0.81	217	0.10	0.37	1.28
PS1	RT 108 PUMPING STATION	46,764	3.33	495	0.40	1.49	5.23
	Total Patuxent	215,616	13.28	6,568	4.84	7.21	25.33
BB1	BONNIE BRANCH (METER)	7,984	0.46	10	0.03	0.07	0.56
BB2	BONNIE BRANCH	2,115	0.11	0	0.00	0.02	0.12
D	DANIELS AREA	1,935	0.11	15	0.00	0.02	0.13
DP1	DEEP RUN	6,055	0.37	503	0.35	0.11	0.84
DP2	DEEP RUN	4,004	0.22	76	0.04	0.04	0.30
DP3	DEEP RUN	5,437	0.28	300	0.07	0.05	0.40
DP5	DEEP RUN	9,465	0.59	576	0.19	0.12	0.90
DP8	DEEP RUN	1,672	0.09	449	0.09	0.03	0.20
DP11	DEEP RUN	23,397	0.67	168	0.13	0.12	0.92
EC	ELLCOTT CITY	9,614	0.49	150	0.17	0.10	0.76
RB	ROCKBURN BRANCH	3,243	0.13	0	0.00	0.02	0.16
SB1	SUCKER BRANCH	6,440	0.41	25	0.04	0.07	0.52
SB2	SUCKER BRANCH	9,799	0.55	147	0.13	0.10	0.79
	Total Patapsco	91,158	4.49	2,418	1.24	0.86	6.59
	Total in PSA	306,774	17.76	8,986	6.08	8.07	31.91

Notes:

1. Ave Residential Flow (gcpd) is based on existing residential use summarized by flow meter drainage area and DPZ population projections.
2. Ave Industrial Commercial Flow is based on existing use plus the incremental acreage provided by DPZ
3. I/I Contribution is based on the Allocation Report comparison of metered flows versus billed water usage as follows:

PATUXENT = 72% of Total Average Flow attributed to Water Usage
 PATAPSCO = 87% of Total Average Flow attributed to Water Usage

**TABLE 9A
FLOW PROJECTIONS BY DRAINAGE AREA (MGD)**

2035

Location Code	Subdrainage Area	Population Served	Average Residential Flow ¹	Industrial Commercial Acres	Average Industrial Commercial Flow ²	Average I&I Flow ³	Total Average Flow
DR	DORSEY RUN PUMPING	12,299	0.73	1,583	0.78	0.60	2.11
GR1	GUILFORD RUN (LP WRP)	750	0.04	512	0.65	0.27	0.97
GR2	GUILFORD RUN	7,029	0.37	795	0.28	0.26	0.91
HB1	HAMMOND BRANCH	0	0.00	86	0.02	0.01	0.03
HB2	HAMMOND BRANCH	20,478	1.57	457	0.57	0.85	2.99
HB3	HAMMOND BRANCH	1,684	0.26	100	0.39	0.26	0.90
LP1	LITTLE PATUXENT	3,875	0.20	177	0.05	0.10	0.34
LP2	LITTLE PATUXENT	78,203	4.32	1,452	1.18	2.19	7.68
MP	MIDDLE PATUXENT	31,868	1.86	774	0.47	0.93	3.25
NL1	NORTH LAUREL PUMPING	16,371	0.83	217	0.10	0.37	1.30
PS1	RT 108 PUMPING STATION	46,776	3.34	505	0.41	1.49	5.24
	Total Patuxent	219,333	13.51	6,657	4.89	7.32	25.72
BB1	BONNIE BRANCH (METER)	7,984	0.46	10	0.03	0.07	0.56
BB2	BONNIE BRANCH	2,115	0.11	0	0.00	0.02	0.12
D	DANIELS AREA	1,935	0.11	15	0.00	0.02	0.13
DP1	DEEP RUN	6,441	0.39	524	0.37	0.11	0.87
DP2	DEEP RUN	4,004	0.22	76	0.04	0.04	0.30
DP3	DEEP RUN	5,437	0.28	300	0.07	0.05	0.40
DP5	DEEP RUN	9,692	0.61	576	0.19	0.12	0.91
DP8	DEEP RUN	2,208	0.12	459	0.09	0.03	0.24
DP11	DEEP RUN	23,409	0.67	168	0.13	0.12	0.92
EC	ELLICOTT CITY	9,614	0.49	150	0.17	0.10	0.76
RB	ROCKBURN BRANCH	3,243	0.13	0	0.00	0.02	0.16
SB1	SUCKER BRANCH	6,440	0.41	25	0.04	0.07	0.52
SB2	SUCKER BRANCH	9,799	0.55	147	0.13	0.10	0.79
	Total Patapsco	92,320	4.55	2,449	1.26	0.87	6.68
	Total in PSA	311,653	18.06	9,105	6.15	8.19	32.40

2040

Location Code	Subdrainage Area	Population Served	Average Residential Flow ¹	Industrial Commercial Acres	Average Industrial Commercial Flow ²	Average I&I Flow ³	Total Average Flow
DR	DORSEY RUN PUMPING	12,311	0.73	1,627	0.81	0.61	2.15
GR1	GUILFORD RUN (LP WRP)	750	0.04	512	0.65	0.27	0.97
GR2	GUILFORD RUN	7,032	0.37	795	0.28	0.26	0.91
HB1	HAMMOND BRANCH	0	0.00	86	0.02	0.01	0.03
HB2	HAMMOND BRANCH	20,478	1.57	457	0.57	0.85	2.99
HB3	HAMMOND BRANCH	1,684	0.27	100	0.39	0.26	0.91
LP1	LITTLE PATUXENT	3,875	0.20	177	0.05	0.10	0.34
LP2	LITTLE PATUXENT	78,512	4.34	1,452	1.18	2.19	7.71
MP	MIDDLE PATUXENT	32,567	1.90	774	0.47	0.94	3.31
NL1	NORTH LAUREL PUMPING	16,587	0.83	217	0.10	0.37	1.31
PS1	RT 108 PUMPING STATION	46,776	3.34	505	0.41	1.49	5.24
	Total Patuxent	220,572	13.58	6,701	4.91	7.36	25.85
BB1	BONNIE BRANCH (METER)	7,984	0.46	10	0.03	0.07	0.56
BB2	BONNIE BRANCH	2,115	0.11	0	0.00	0.02	0.12
D	DANIELS AREA	1,935	0.11	15	0.00	0.02	0.13
DP1	DEEP RUN	6,441	0.39	561	0.39	0.12	0.90
DP2	DEEP RUN	4,004	0.22	76	0.04	0.04	0.30
DP3	DEEP RUN	5,437	0.28	300	0.07	0.05	0.40
DP5	DEEP RUN	9,692	0.61	576	0.19	0.12	0.91
DP8	DEEP RUN	2,281	0.12	488	0.11	0.03	0.26
DP11	DEEP RUN	23,415	0.67	168	0.13	0.12	0.92
EC	ELLICOTT CITY	9,614	0.49	150	0.17	0.10	0.76
RB	ROCKBURN BRANCH	3,243	0.13	0	0.00	0.02	0.16
SB1	SUCKER BRANCH	6,440	0.41	25	0.04	0.07	0.52
SB2	SUCKER BRANCH	9,799	0.55	147	0.13	0.10	0.79
	Total Patapsco	92,399	4.56	2,515	1.29	0.88	6.73
	Total in PSA	312,972	18.14	9,216	6.21	8.24	32.58

Notes:

1. Ave Residential Flow (gcpd) is based on existing residential use summarized by flow meter drainage area and DPZ population projections.
2. Ave Industrial Commercial Flow is based on existing use plus the incremental acreage provided by DPZ
3. I/I Contribution is based on the Allocation Report comparison of metered flows versus billed water usage as follows:

PATUXENT = 72% of Total Average Flow attributed to Water Usage
 PATAPSCO = 87% of Total Average Flow attributed to Water Usage

**TABLE 10
INVENTORY OF EXISTING WASTEWATER TREATMENT PLANTS**

Name and Operating Agency	Treatment Type	Plant Coordinate Location (North/East)	Occupied Acres	Vacant Acres	Point of Discharge	Max. Site Capacity Secondary (MGD)	Max. Site Capacity Advanced (MGD)	Existing Capacity (MGD)	Avg. Flow (MGD)	Peak Flow (MGD)	Planned or Expected Date to Abandon (if Interim)
Municipal (Public)											
Little Patuxent Water Reclamation Plant	BS-GR-PS-AS-NO-PR-NR-SF-CH-D-DW-CT-PA	531/1,365			Little Patuxent			29.0	17.2	36.0	
Sheppard Manor (Table 10B)	SS	575/1,331			Shared Septic			0.008	0.004	0.017	
Walnut Creek (Table 10B)	SS	562/1,325			Shared Septic			0.112	0.056	0.220	
Riverwood (Table 10B)	SS	576/1,339			Shared Septic			0.005	0.005	0.020	
Industrial											
Maryland-Virginia Milk Producers	PS-O-GC-AS	538/1,349			Hammond Branch				0.192	0.270	
Owens Corning Fiberglas	PS	538/1,372			Unnamed tributary to Dorsey Run				0.029		
Private, Community & Institutional											
St. Louis Catholic School	ST-ISF-CH-DC	555/1,327			Subsurface Discharge			.006	0.003	unknown	
Villas at Cattail Creek	ST-PS-NR-PA	588/1,300			Subsurface Discharge				0.017	0.0384	
Homeland Marriottsville Senior Center	ST-ISF-CH-DC	591/1,341			Subsurface Discharge				0.025	unknown	
Glenelg High School	BS-AE-NR	585/1,313			Subsurface Discharge				0.025	0.050	
Western Elementary School	BS-AE-NR	573/1,317			Subsurface Discharge				0.008	0.014	
Bushy Park Elementary, Glenwood Middle, Glenwood Park Elementary School	BS-AD-AN	595/1,308			Subsurface Discharge				0.012	0.023	

TABLE 10

INVENTORY OF EXISTING WASTEWATER TREATMENT PLANTS

Key to Treatment Types

AD	Aerobic Digestion	ISF	Intermittent Sand Filter
AE	Extended Aeration	KC	Chemical Flocculation
AN	Anaerobic Digestion	L	Lagoon
AS	Activated Sludge	NO	Nitrogen Oxidation
BS	Bar Screen	NR	Nitrogen Removal
CG	Comminutor or Grinding	O	Grease Removal
CH	Hypochlorate Chlorination	OZ	Ozonation Disinfection
CIM	Clarigester	PA	Post Aeration
CT	Chemical Treatment	PR	Phosphorus Removal
D	Dechlorination (other)	PS	Primary Settling
D	Disinfection (other)	RBC	Rotating Biological Contractor
DC	Dechlorination SO ₂ gas	SB	Sand Drying Beds
DW	Sludge Dewatering – Mechanical	SD	Secondary Treatment (other)
FTH	Filters - High Capacity	SF	Polishing Sand Filter
GC	Gas Chlorination	SS	Shared Septic
GR	Grit Removal	ST	Septic Tank
I	Sewage Application to Land	TF	Trickling Filter
		UV	Ultraviolet Disinfection

**TABLE 10A
SUMMARY OF EXISTING AND PLANNED PERMIT DISCHARGES**

Facility	State Permit Number	NPDES Permit Number	Permit Type	Actual Average Flow (MGD)
Alpha Ridge Munciple Landfill	13DP3224	MD0067865	Industrial Individual	0.082
American Infrastructure-MD, Inc. - Jessup Asphalt	10MM2110	MDG492110	General Permit - Mineral Mine	NA
Annapolis Junction RMC Plant	10MM8018	MDG498018	General Permit - Mineral Mine	NA
Ashleigh Knolls Subdivision	14DP3102	MD3102N06	Groundwater	NA
Bardon, Inc. (dba Aggregate Industries)	10MM9804	MDG499804	General Permit - Mineral Mine	NA
Bay Ready Mix Concrete	10MM8028	MDG498028	General Permit - Mineral Mine	No Discharge
Carrs Mill Landfill	13DP3226	MD0067873	Industrial Individual	0.0627
Daniel G. Schuster Inc. - Jessup	10MM9739	MDG499739	General Permit - Mineral Mine	NA
Dayton Oaks Elementary School	09DP3479	MD3479N04	Groundwater	0.0042
Eyre's Bus Service, Inc.	11DP2349	MD2349N00	Groundwater	0.0017
General Electric Company - Former Appliance Park East Facility	12DP3245	MD0067938	Industrial Individual	0.01
Glenelg Country School WWTP	12DP3409	MD3409N02	Groundwater	0.0013
Glenelg High School WWTP	10DP3412	MD3412N02	Groundwater	0.025
Homeland Senior Living Community WWTP	10DP3435	MD3435N03	Groundwater	0.020
Howard County Bureau of Utilities - Elevated Water Tanks	11HT9501	MDG679501	Hydrostatic Testing	NA
Jessup Plant	10MM8053	MDG498053	General Permit - Mineral Mine	0.028
Jessup Ready Mix Concrete Plant	10MM8046	MDG498046	General Permit - Mineral Mine	No Discharge - less than 0.0001
Johns Hopkins University - Applied Physics Laboratory	11HT5179	MDG675179	General Permit - Hydrostatic Testing	NA
Johns Hopkins University - Applied Physics Laboratory	12DP3607	MD0070009	Industrial Individual	Pipe 1 - 0.044, Pipe 2 - NA
Lisbon Shopping Plaza WWTP	14DP3405	MD3405N02	Groundwater	System A- 0.0078, System B- NA
Little Patuxent Water Reclamation Plant	13DP1421	MD0055174	Surfacewater Municipal	20.7
Manor Hill Brewing	15DP3823	MD3823G15	Groundwater	NA
Marriotts Ridge High School WWTP	14DP3417	MD3417N02	Groundwater	0.009
Maryland & Virginia Milk Producers Assoc.	15DP0033	MD0000469	Industrial Individual	0.325
Modern Foundations Inc.	10MM8066	MDG498066	General Permit - Mineral Mine	0.002
Mount Airy Bible Church, Inc.	10DP3691	MD3691N10	Groundwater	NA
New Bushy Park Elementary & Glenwood Middle Schools WWTP	11DP3521	MD3521N05	Groundwater	0.0072
New Cut Landfill	13DP3262	MD0068039	Industrial Individual	0.085
Peddicord Property WWTP	11DP3506	MD3506N05	Groundwater	0.0025
Piccirilli Quarry	10MM9891	MDG499891	General Permit - Mineral Mine	No Discharge
Rockville Fuel and Feed	10MM9770	MDG499770	General Permit - Mineral Mine	0.00078
Savage Stone, LLC	10MM9765	MDG499765	General Permit - Mineral Mine	Pipe 1- 0.058, Pipe 2- 0.330
Riverwood Phase II Shared Sewage Facility	11DP3544	MD3544N06	Groundwater	0.0042
The Villas at Cattail WWTP & WTP	11HT5050	MDG675050	General Permit - Hydrostatic Testing	NA
The Villas at Cattail WWTP & WTP	14DP3260	MD3260N98	Groundwater	0.014
Triadelphia Ridge Elementary School	13DP3223	MD3223N07	Groundwater	0.0086
University of MD Agricultural Center	11HT5165	MDG675165	General Permit	NA
W.R. Grace & Company	07DP3254	MD0067997	Industrial Individual	No Discharge
Wah Property	14DP3598	MD3598N14	Groundwater	NA
Walnut Creek Subdivision	11DP3538	MD3538N06	Groundwater	NA
Walnut Grove Shared Facility WWTP	11DP3504	MD3504N05	Groundwater	0.0502
Western Regional Park WWTP	10DP3448	MD3448N03	Groundwater	0.00023

Note: Facilities that did have records of actual average flow or total design flow quantities are marked NA

**TABLE 10B
EXISTING & PROPOSED SHARED SEPTIC SYSTEMS**

Subdivision Name	Community	Contract No.	MDE Groundwater Permit	Gravity or Pressure Dose	Pre-Treatment	Code Requirement*1	No. of Connected Lots	MDF*2 (gpd)	ADF*3 (gpd)	Year In Service (FY)
Ashleigh Knolls	Clarksville	50-3357, 50-3382, 50-3383	Yes: Permit renewal pending SBR construction	Pressure	No	Yes	109	32,700	16,350	1996
Brantwood	West Friendship	50-3816	No	Gravity	No	Yes	7	5,250	2,100	2001
Edgewood Farm	Glenwood	50-4309	No	Gravity	No	Yes	8	4,800	2,400	2013
Friendship Lakes	West Friendship	50-3871	No	Gravity	No	Yes	5	3,750	1,875	2002
Fulton Ridge *6	Fulton	50-4293	No	Pressure	No	Yes	4	3,000	1,500	2008
Fulton Woods	Fulton	50-4361	No	Gravity	No	Yes	8	4,950	2,475	
Hopkins Choice *4	Glenelg	50-4254	No	Pressure Dose	No	Yes	16	9,900	4,950	2011
Kogan Trust Property	Glenelg	Not applied for	No	Gravity	No	Yes	3	2,250	1,125	
Lyndonbrook *4	West Friendship	50-3607	No	Gravity	No	Yes	11	6,600	3,300	1998
Maple Ridge	Cooksville	50-4046	No	Gravity	No	Yes	7	4,200	2,100	2003
Maplewood Farms	Glenwood	50-4458 50-4459	No	Pressure Dose	No	Yes	7	4,950	2,475	2011
Marty Howard Property *6	Clarksville	50-4381	No	Pressure Dose	Yes	Yes	5	3,750	1,875	
Musgrove Property *5	Glenelg	Board of Education Project	Yes	Pressure	Yes	Yes	31	18,600	9,300	2007

**TABLE 10B
EXISTING & PROPOSED SHARED SEPTIC SYSTEMS**

Subdivision Name	Community	Contract No.	MDE Groundwater Permit	Gravity or Pressure Dose	Pre-Treatment	Code Requirement*1	No. of Connected Lots	MDF*2 (gpd)	ADF*3 (gpd)	Year In Service (FY)
Neshawat Property *6	Glenelg	50-4294	No	Gravity	Yes	Yes	4	6,000	3,000	2009
Owings Property Lot 3	Highland	50-4157	No	Gravity	No	Yes	7	4,200	2,100	2006
Owings Property Lot 5	Highland	50-4436	No	Gravity	No	Yes	7	4,200	2,100	
Paddocks East	West Friendship	50-4156	No	Gravity	Yes	Yes	8	4,950	2,475	2010
Pickett Property	Lisbon	50-4386	Yes	Pressure Dose	Yes	Yes	21	13,500	6,750	
Pindell Woods	Fulton	50-3952	No	Gravity	No	Yes	2	1,200	600	2004
Quartz Hill Estates	Glenwood	50-4460	No	Gravity	No	Yes	6	3,750	1,875	
Regan Property	Highland	50-4748	No	Gravity	Yes	Yes	6	4500	2250	2014
Riggs Meadow	Cooksville	50-3606	No	Gravity	No	Yes	4	2,400	1,200	2002
Riverwood *5	Ellicott City	50-4287	06-DP-3544	Pressure Dose	Yes	Yes	18	10,800	5,400	2013
Sheppard Manor *5	Ellicott City	50-4357	05-DP-3506	Pressure Dose	Yes	Yes	11	8,250	4,125	2009
Triadelphia Crossing	Glenelg	50-4207	No	Gravity	No	Yes	8	4,800	2,400	2005

**TABLE 10B
EXISTING & PROPOSED SHARED SEPTIC SYSTEMS**

Subdivision Name	Community	Contract No.	MDE Groundwater Permit	Gravity or Pressure Dose	Pre-Treatment	Code Requirement* ¹	No. of Connected Lots	MDF* ² (gpd)	ADF* ³ (gpd)	Year In Service (FY)
Walnut Creek * ⁵	Clarksville	50-4440 Collection 50-4441 Treatment	Yes	Pressure Dose	Yes	Yes	149	111,750	55,875	2013
Walnut Grove * ⁵	Clarksville	50-4330 Collection & 50-4359 Treatment	Yes	Pressure	Yes	Yes	87	65,250	32,625	2009
Willow Pond	Highland	50-4491	No	Pressure Dose	No	Yes	3	2,250	1,125	2011
Willow Ridge	Ellicott City	54-4301	No	Gravity	No	Yes	5	3,750	1,875	2013

*¹ – Code Requirement is to meet current Howard County requirements

*² – Maximum Daily Flow

*³ – Average Daily Flow

*⁴ – 2 separate areas

*⁵ – SBR

*⁶ – Private Units

TABLE 10C

SUMMARY OF EXISTING AND PLANNED COMMUNITY SEPTIC SYSTEMS

Facility Name	Community	Application/Permit Number	Permit or Revision Processing Status	Status / Date
Ellicott Meadows	Ellicott City	03-DP-3435	Permit Issued 2003	In operation, compliant
The Villas at Cattail Creek	Glenwood	05-DP-3260	Permit Issued, October 1, 2009	In operation, compliant

TABLE 11

PROBLEM AREAS INVENTORY - INDIVIDUAL AND COMMUNITY

Service Area	Problem Description	Location	Population ⁽¹⁾	Area (Acres) ⁽²⁾	Treatment Demand (MGD) ⁽³⁾	Planned Correction Date
Patapsco	7 overflowing septic systems	878-508 Rockburn Hill Road	21	5	.002	Comprehensive service area
Outside Planned Service Area	3 homes with advanced pretreatment; 1 home with a holding tank	Western side of Hall Shop Road, between Guilford Rd. and Simpson Rd.	21 homes	--	--	Outside planned service area
Outside Planned Service Area	An old town center with small lots. Close proximity of wells and onsite sewage disposal systems may be responsible for bacterial contamination of well water and ground water	Lisbon, a town center on Route 144 between the 15800 and 16100 blocks	Approx. 60 properties (Residential and Commercial)	--	--	Outside planned service area

- (1) Population was computed by multiplying the average number of people per dwelling unit by the number of houses with failing septic systems. Assumed 3.0 persons/unit.
- (2) Acreage determined by multiplying the average lot size in the area by the number of dwellings with failing septic systems.
- (3) Treatment demand determined by multiplying the population by an assumed per capita flow and with an infiltration/inflow allowance as used elsewhere in this Plan.

Table 12 (Storm Drainage Outfalls and Non-Point Sources)
is not part of this Water & Sewerage Master Plan.

TABLE 13
IMMEDIATE, 5-YEAR, 10-YEAR and COMPREHENSIVE PRIORITIES for SEWER SYSTEM DEVELOPMENT

Priorities Map Key (Fig 4-3)	Capital Project Number	County Priority Assigned	Coordinate Location	Description	Project Costs (\$)			Project Schedule		
					Total	PL660 Eligibility	Local	Prelim. Plans	Start Const.	Compl. Const.
	S-6189	Under Const.	1363-524	A project for the design and construction of improvements to the North Laurel Sewage Pumping Station to increase the pumping capacity of the station.	9,130,000	-	9,130,000	2004	2014	2015
	S-6232	In Progress		A project to televise sewer pipes in the County's sanitary sewer system for evidence of corrosion. This project will effect repairs area where corrosion has compromised the integrity of the system.	11,975,000	-	11,975,000	on-going	on-going	on-going
	S-6237	In Progress		A project for Howard County's participation in the cost sharing for the capital funding of the Patapsco Treatment Plant at Wagners Point and the related Patapsco Interceptor, Pump Station, and Force Main.	58,000,000	-	58,000,000	on-going	on-going	on-going
	S-6249	In Progress		An appropriation is requested under this project to construct water, sewer and associated facilities in subdivisions where the developer has failed to build all facilities in accordance with the plans and Developer's Agreement.	3,600,000	-	3,600,000	on-going	on-going	on-going
	S-6260	Under Const.	1390-567	A project to provide sewer service to properties along Rockburn Hill Road.	4,025,000	-	4,025,000	2012	2014	2015
	S-6264	In Progress	1365-530	FY2008 Little Patuxent Water Reclamation Plant capital repairs	30,583,000	-	30,583,000	on-going	on-going	on-going
	S-6268	In Progress		A project to protect and stabilize sewers in areas where stream and soil erosion have compromised the integrity of the sewer system to convey wastewater to the County's treatment facilities.	6,780,000	-	6,780,000	on-going	on-going	on-going
	S-6269	Under Const.	1331-547	Design and installation of a sequential batch reactor wastewater treatment system for the Ashleigh Knolls Shared Septic Facility.	824,000	-	824,000	2014	2016	2017
A	S-6271	Under Const.	1386-555	Construction of 160 LF of Deep Run Inverted Siphon 3rd Barrel and replacement of 1,700 LF of existing sewer in Furnace Avenue.	1,660,000		1,660,000	2013	2014	2015
	S-6273	In Progress		A project to re-line and repair 55,000 LF of the original Little Pautuxent Interceptor sewer from LPWRP to MD Route 108.	12,000,000	-	12,000,000	2011	2013	2015
B	S-6274	0-5 Years		Design and construction of 2,500 LF interceptor sewer parallel to the existing Little Pautuxent Interceptor and upstream of MD Route 108 SPS.	2,000,000	-	2,000,000	2015	2017	2019
	S-6275	0-5 Years	1366-597	A project of the study, design and construction of a wastewater pumping station and force main to serve the Daniels Area east of Old Frederick Road including improvements and upgrades to the Old Frederick Road WWPS	1,800,000	-	1,800,000	2013	2015	2016
	S-6276	In Progress		Sewer manhole and pipeline cleaning and television inspection maintenance. Consent Agreement Compliance monitoring and reporting, and a sewer GIS database.	7,336,000	-	7,336,000	on-going	on-going	on-going
	S-6277	0-5 Years	1369-596	Design and construction of 750 linear feet sewer in Old Frederick Road north of Howard Run Drive to serve 6 properties.	230,000	-	230,000	2014	2014	2015
	S-6279	0-5 Years		Design and construction of 2,500 LF of 8-inch replacement force main and improvements to the Meadowridge Road Wastewater Pumping Station.	1,900,000	-	1,900,000	2014	2015	2016
C	S-6280	In Progress		A project for the study, design and construction of 20,000 LF of sewers to parallel existing sewers in the Hammond Branch and Patuxent sewer drainage areas to provide additional capacity.	26,505,000	-	26,505,000	2018	2021	2022

TABLE 13
IMMEDIATE, 5-YEAR, 10-YEAR and COMPREHENSIVE PRIORITIES for SEWER SYSTEM DEVELOPMENT

Priorities Map Key (Fig 4-3)	Capital Project Number	County Priority Assigned	Coordinate Location	Description	Project Costs (\$)			Project Schedule		
					Total	PL660 Eligibility	Local	Prelim. Plans	Start Const.	Compl. Const.
D	S-6281	In Progress		A project for the study, design and construction of 14,600 LF of sewers parallel to existing sewers in the Dorsey Run and Guilford Run sewer drainage areas to provide additional capacity.	13,365,000	-	13,365,000	2019	2020	
E	S-6282	In Progress		A project of the design and construction of 6,000 LF of sewers parallel to existing sewers in the Bonnie Branch sewer drainage area to provide additional capacity. The project includes the upgrade and re-commissioning o the Kerger Road WWPS and force main.	5,325,000	-	5,325,000	2016	2017	2018
F	S-6283	In Progress		A project for the design and construction of 18,000 LF of sewers parallel to existing sewers in the Tiber Branch and Sucker Branch sewer drainage areas to provide additional capacity.	9,305,000	-	9,305,000	2016	2017	2018
G	S-6284	In Progress		A project of the design and construction of 39,000 LF of sewers parallel to existing sewers in the Deep Run and Shallow Run sewer drainage areas to provide additional capacity. Project will consist of 2 phases.	20,210,000	-	20,210,000	2017	2018	2019
H	S-6285	0-5 Years		A project for the design and construction of 1,700 LF of sewers parallel to existing sewers in the Tiber Branch sewer drainage area to support flow from the MD Route 108 WWPS	1,300,000	-	1,300,000	2017	2018	2019
	S-6286	In Progress		A project to upgrade and increase the pumping capacity of the Dorsey Run wastewater pumping station.	4,567,000	-	4,567,000	2016	2017	2018
	S-6287	6-10 Years		A project of the design and construction of 4,600 LF of force main parallel to the existing force main to supplement the pumping capacity of the North Laurel wastewater pumping station.	1,800,000	-	1,800,000	2021	2022	2023
	S-6288	6-10 Years		A project to upgrade and increase the pumping capacity of the Rockburn wastewater pumping station.	3,320,000	-	3,320,000	2020	2021	2022
	S-6289	0-5 Years		A project of the design and construction of 350 LF of 8-inch sewer to serve three properties on Park Avenue in Ellicott City.	225,000	-	225,000	2015	2016	2017
	S-6290	0-5 Years		A project of the study, design and construction to re-align 3,500 LF of sewers in the vicinity of Baltimore and Washington Streets in Savage, MD	3,250,000	-	3,250,000	2016	2017	2018
	S-6291	In Progress		A project of the design and construction of 250 LF of sewer to serve one property located on Old Frederick Road.	90,000	-	90,000	2014	2015	2015
	S-6292	In Progress		A project of the design and construction of 900 LF of sewer to serve four properties located on Old Frederick Road and Toby Lane.	300,000	-	300,000	2015	2016	2017
	S-6293	0-5 Years		A project of the design and construction of 2,000 LF of sewers to serve three properties located along US Route 40 near Turf Valley Road.	700,000	-	700,000	2016	2016	2017
	S-6294	0-5 Years		A project of the renovation of the Annapolis Junction wastewater pumping station on Henkel's Lane.	275,000	-	275,000	2015	2016	2017
	S-6295	0-5 Years		A project to design and construct new Biosolids Processing Facilities and the LPWRP to comply with new State biosolids and storage and disposal regulation, achieve biosolids volume reduction and enhance biosolids quality for end use purposes.	84,000,000	-	84,000,000	2016	2017	2019
	S-6296	0-5 Years		A project of the design and construction of 150 LF of sewer to serve one property on Harriet Tubman Lane.	440,000	-	440,000	2016	2017	2017

TABLE 13
IMMEDIATE, 5-YEAR, 10-YEAR and COMPREHENSIVE PRIORITIES for SEWER SYSTEM DEVELOPMENT

Priorities Map Key (Fig 4-3)	Capital Project Number	County Priority Assigned	Coordinate Location	Description	Project Costs (\$)			Project Schedule		
					Total	PL660 Eligibility	Local	Prelim. Plans	Start Const.	Compl. Const.
	S-6297	0-5 Years		A project of the design and construction to upgrade and increase the pumping capacity of the Old Frederick Road wastewater pumping station. The project includes improvements to the discharge force main and downstream sewer.	1,735,000	-	1,735,000	2016	2018	2017
	S-6698	In Progress		A project to design and construct routine sewer main extensions in the Metro District requested by landowners. 1. To serve existing dwellings in recorded residential subdivisions where sewer mains have not been constructed. 2. With existing dwellings or businesses on failing private systems as identified by the County Health Department. 3. To serve parcels with existing dwellings. These routine extensions must also meet the following: a. A written request has been made by a property owner who is without a sewer main fronting their property. b. Properties to be served must abut County or State road. c. The extension is less than 1,000 feet. d. The extension is a gravity sewer main and continue a sewer main currently in the service within the sewer shed. e. It does not require acquisition of utility easements. f. Capacity is available per section 18.122B County Code. g. The extension is supported by a least 50% of the abutting property owners.	6,750,000	-	2,500,000	on-going	on-going	on-going
	S-6699	In Progress		A project of the study, design and construction of sewer infrastructure to convert existing properties that currently use on-site septic systems to public sewer service.	18,000,000	-	18,000,000	on-going	on-going	on-going
	S-6711	In Progress		A project to provide engineering or administrative services, computer asset management, inspection, testing, inspector training, supplies and equipment including vehicles necessary for site inspection for the implementation of developer projects to make additions to the public water and sewer systems.	6,000,000	-	6,000,000	on-going	on-going	on-going
	S-6812	In Progress		FY 2012, A project to provide construction and inspection service to sites which do not require developer agreement but require 8" and larger sewer house connections and other sewer appurtenances.	150,000	-	150,000	on-going	on-going	on-going
	S-6862	In Progress		FY 2012, A project to provide the construction of sewer house connections by the Bureau of Utilities for residential size (4" or 6") connections. These connections are made when new sewer house connection are required for lots or homes where none exists.	150,000	-	150,000	on-going	on-going	on-going
	S-6950	In Progress		A program for the reimbursement to developers for construction of water and sewer house connections to existing lots outside of their subdivision.	180,000	-	180,000	on-going	on-going	on-going

TABLE 13
IMMEDIATE, 5-YEAR, 10-YEAR and COMPREHENSIVE PRIORITIES for SEWER SYSTEM DEVELOPMENT

Priorities Map Key (Fig 4-3)	Capital Project Number	County Priority Assigned	Coordinate Location	Description	Project Costs (\$)			Project Schedule		
					Total	PL660 Eligibility	Local	Prelim. Plans	Start Const.	Compl. Const.
	S-6960	In Progress		A program to reimburse developers for construction of major sewer and water facilities as shown on the approved Howard County Water & Sewer Master Plan	3,000,000	-	3,000,000	on-going	on-going	on-going
I		0-5 Years		Furnace Avenue Sewer Improvements Phase 1-A. Project for the design and construction of 1,420 LF of 12-inch to 15-inch supplemental parallel interceptor sewer to provide additional capacity						
J		6-10 Years		Furnace Avenue Sewer Improvements Phase 2-A. Project for the design and construction 1,820 LF of 12-inch to 18-inch supplemental parallel interceptor sewer.						
K		6-10 Years		Furnace Avenue Sewer Improvements Phase 2-A. Project of the design and construction of 255 LF of 8-inch supplemental parallel interceptor sewer to provide capacity						
L		6-10 Years		Licking Creek Interceptor Improvements Phase 2. A project for the design and construction of 3,600 LF of 12-inch to 16-inch supplemental parallel interceptor sewer to provide additional capacity.						
	Developer Project	0-5 Years	1344-597	Construction of 2,600 ft. of interceptor to serve areas west of Turf Valley Road.						
	Developer Project	6-10 Years	1390-566	Construction of two 100 gpm (0.14 mgd) pump stations and force mains in the Lawyer's Hill area to serve properties between Montgomery Road and I-95.						
	Developer Project	Comprehensive	1372-579	Construction of pump stations and force main with capacities of approximate 100 gpm (0.14 mgd) to serve properties east of College Avenue.						
	Developer Project	Comprehensive	1369-595	Construction of a 100 gpm (0.14 mgd) Church Lane pump station and force main to serve property north of Deerfield Road.						

	In Progress
	0-5 years (2020)
	6-10 years (2025)
	11-15 years (2030)

Table 14 (Water & Sewerage Map Symbols)
is not part of this Water & Sewerage Master Plan.
Map symbols are provided with the map legends.

TABLE 15

FLOW MONITORING DATA: WASTEWATER TREATMENT PLANTS

Service Area	Design parameters (permit)					CY 2013 Flow (mgd)		Development Units	
	Hydraulic (mgd)	Organic (Monthly, mg/l)				Average Day	Maximum Day	Existing	Anticipated Buildout
		BOD	TSS	Total N	TP				
Little Patuxent Water Reclamation Plant	29.0	5 (S) 26 (W)	26	309,715 lbs/yr ⁽⁵⁾	23,358 lbs/yr ⁽⁵⁾	18.9 ⁽³⁾	37.64	69,500 (R)	87,900 (R)
Patapsco Wastewater Treatment Plant	11.57 ⁽¹⁾	165 to 251 ⁽²⁾	137 to 202	22.0 to 30.5 mg/l	3.2 to 4.4 mg/l	6.1 ⁽⁴⁾	N/A	26,900 (R)	37,400 (R)

- (1) The County's total share capacity for the Patapsco WWTP is projected to be approximately 11.57 MGD.
- (2) Influent flow and concentrations for the Patapsco WWTP from Year 1998 to Year 2006, from the *City of Baltimore Comprehensive Wastewater Facilities Master Plan, 2004*.
- (3) The Annual Average Daily Flow for Calendar Year 2013 excludes approximately 1.3 MGD of flow that was flow diverted to the Patapsco WWTP basin through the Route 108 Pumping Station.
- (4) The Annual Average Daily Flow for Calendar Year 2013 includes approximately 1.3 MGD of flow diverted to the Patapsco WWTP basin through the Route 108 Pumping Station.
- (5) When the average annual wastewater flow approaches 29 MGD, an annual total nitrogen concentration of 3.5 mg/L and total phosphorus concentration of 0.25 mg/L would be necessary to achieve an annual TN load of 309,715 and TP load of 23,358 lbs/yr.

**TABLE 15A
FLOW ANALYSIS TABLE**

Drainage Area Location Code	Subdrainage Area	Pipe Segment(s) ⁽¹⁾		Current Piping (MGD)		Improved Piping (MGD)	
		Downstream Node ID	Upstream Node ID	Flow Capacity ⁽²⁾	Projected Peak Flow ⁽³⁾	Flow Capacity ⁽²⁾	Projected Peak Flow ⁽³⁾
PATUXENT SEWER DRAINAGE BASIN							
PS1	LITTLE PATUXENT AT ROUTE 108 P.S.	46361210b	9693	9.759	9.265	20.325	10.039
	System Improvement	4636-JC1e	LP2--001-				
LP2	LITTLE PATUXENT AT MIDDLE PATUXENT	4532-217	4532-218	58.061	25.438	58.061	25.709
LP1	LITTLE PATUXENT AT LP WRP	237-3733	4531--96	33.367	31.863	33.367	32.465
	System Improvement	237-3733	4531--98				
MP	MIDDLE PATUXENT	720-102	720-103	12.783	6.005	12.783	6.005
HB3	HAMMOND BRANCH AT BURSA ROAD	50-1105	50-1105A	3.690	5.345	7.613	7.208
	System Improvement	50-1105	HB1A1-01-				
HB2	HAMMOND BRANCH AT U.S. ROUTE 1	50-1105	50-1117	3.800	5.325	8.027	5.389
	System Improvement	50-1105	HB2--015-				
HB1	HAMMOND BRANCH AT LP WRP	1601-5	1601-6	25.243	8.601	25.250	12.318
NL1	NORTH LAUREL PUMPING STATION	NL1--001e	49-1070	2.023	3.097	4.466	3.743
	System Improvement	NL1--001e	Improvement				
GR2	GUILFORD RUN AT ANNAPOLIS JUNCTION	235-3163	235-3164	5.293	3.386	5.293	3.386
GR1	GUILFORD RUN AT LP WRP	235-3152	235-3153	14.173	12.715	14.173	13.033
DR	DORSEY RUN PUMPING STATION	Dorsey Run PS	678-9686	39.953	6.853	39.953	8.793
PATAPSCO SEWER DRAINAGE BASIN							
D	DANIELS AREA(5)	177-2069	177-1176	5.823	1.611	5.823	1.611
SB2	SUCKER BRANCH AT NORMANDY WOODS DR.	1305-P91A	1305-P92	3.218	3.660	8.447	4.393
	System Improvement	PA2H-036-	PA2H-037-				
SB1	SUCKER BRANCH AT FLOW METER	25-523	19-68	4.976	4.495	9.106	5.213
	System Improvement	25-523	PA2H-001-				
EC	TIBER BRANCH AT FLOW METER(4)	25-518C	26-1046A	0.026	9.443	73.210	16.998
	System Improvement	PA1--064A	Improvement				

Drainage Area Location Code	Subdrainage Area	Pipe Segment(s) ⁽¹⁾		Current Piping (MGD)		Improved Piping (MGD)	
		Downstream Node ID	Upstream Node ID	Flow Capacity ⁽²⁾	Projected Peak Flow ⁽³⁾	Flow Capacity ⁽²⁾	Projected Peak Flow ⁽³⁾
BB2	KERGER WEIR TO ROCKBURN P.S.	3697-29	3697-30	3.619	0.281	3.619	0.281
	KERGER ROAD P.S.	1215-108	1215-109	1.312	1.198	1.312	1.198
RB	ROCKBURN PUMPING STATION	3696-202	3696-203	1.952	1.833	4.265	1.877
	System Improvement	3696-202	PA1D2-53-				
BB1	BONNIE BRANCH AT FLOW METER	1659B	1659C	0.071	4.149	0.136	4.113
	System Improvement	1659B	PA1D2-01A				
DP11	DEEP RUN AT U.S. ROUTE 1	1850-1	36-1022	4.970	7.768	15.284	8.877
	System Improvement	DR2--102-	DR2--103-				
DP8	DEEP RUN AT DORSEY ROAD	24-465	1447-101	2.081	5.364	13.798	9.602
	System Improvement	DR2--074-	DR2--075-				
DP5	DEEP RUN AT B&O RAILROAD	506-1	23-385	4.059	5.561	7.846	7.410
	System Improvement	DR2B-021-	DR2B-022-				
DP3	DEEP RUN AT HANOVER ROAD	181-2576	181-2577	7.600	8.180	12.486	10.371
	System Improvement	181-2576	DR2B-001-				
DP1	DEEP RUN AT FLOW METER	25-276	1809-4	48.154	21.766	48.154	25.536
	System Improvement	1809-5	1809-4				
DP2	FURNACE AVENUE	DR1--009a	4727-280A	3.955	1.980	3.955	2.160

Notes:

- (1) Pipe segment(s) selected near bottom of branch. Flow conditions may vary in upstream sewer segments with changes in size and slope.
- (2) Flow capacity calculated using Manning Equation for gravity flow based on pipe size and slope from Howard County record drawings.
- (3) Peak flow values are the peak instantaneous flow rates calculated in the sanitary sewer hydraulic model using Year 2040 projected flow with Rainfall Event A.
- (4) Includes flow from Route 108 Pumping Station.
- (5) Also includes flows from other portions of SB2 area upstream of this pipe segment.

TABLE 16

SEWAGE SLUDGE GENERATION

Little Patuxent Water Reclamation Plant

Year	Annual ADF (MGD)	Estimated Biosolids Production (Dry Tons/Year)	Lime Addition or VS Reduction (Dry Tons/Year)	Total Sewage Sludge Production (Dry Tons/Year)	Estimated Sewage Sludge for Disposal (Wet Tons/Year)
2013 (actual)	18.9	8,200	6,400	14,600	35,743
2015	22.1	9,600 ⁽¹⁾	6,700	16,300 ⁽²⁾	40,700 ⁽³⁾
<i>2015-2020 Advanced Lime RDP Process to be replaced by Anaerobic Digestion & Heat Drying Process</i>					
2020	23.5	10,200 ⁽¹⁾	-4,200 ⁽⁴⁾	6,000	6,500 ⁽⁵⁾
2025	24.5	10,600 ⁽¹⁾	-4,400 ⁽⁴⁾	6,200	6,700 ⁽⁵⁾
2030	25.3	10,900 ⁽¹⁾	-4,500 ⁽⁴⁾	6,400	7,000 ⁽⁵⁾
2035	25.7	11,100 ⁽¹⁾	-4,600 ⁽⁴⁾	6,500	7,100 ⁽⁵⁾
2040	25.9	11,200 ⁽¹⁾	-4,600 ⁽⁴⁾	6,600	7,200 ⁽⁵⁾

Notes:

- (1) Based on biosolids production of 1.185 dry tons per MG of annual average daily flow determined from Annual Sewage Sludge Generator Reports and RDP Biosolids Processing System Evaluation, July 30, 2014, by HDR, Inc.
- (2) Total solids production (biosolids and lime) of 2.019 dry tons per MG of annual average daily flow.
- (3) Total sludge production of 5.047 wet tons per MG of annual average daily flow and 38%-41% total solids.
- (4) Assumes volatile solids content of 85% and 50% VS destruction. Adapted from Biosolids Processing Facilities Improvements- Final Preliminary Engineering Report dated November 2014.
- (5) 92% total solids content, adapted from anaerobic digestion and heat drying design parameters, Biosolids Processing Facilities Improvements- Final PER, Table 6-3.

TABLE 16A
SLUDGE TREATMENT AND DISPOSAL

Little Patuxent Water Reclamation Plant

A. Sludge Treatment Process:

1. Current Operations- Settled solids from the primary clarifiers are collected and pumped to a gravity thickener process. Settled waste activated solids (WAS) from the secondary clarifiers are collected and pumped to a dissolved air flotation process for thickening. After thickening, the solids are combined and dewatered using centrifuges. Lime is applied and mixed with the raw sludge and supplemental heat is added using the advanced alkaline RDP process to raise the temperature of the mix to 160 degrees F for not less than 30 minutes. The process destroys pathogens and produces a stabilized Class A/Exceptional Quality (EQ) sludge cake suitable for direct land application.

2. Future Operations (projected for implementation Year 2020)- Due to recent and pending regulatory changes by the Maryland Department of the Environment (MDE) and the Maryland Department of Agriculture (MDA) that regulate the application of biosolids to bulk agricultural land, the County undertook and completed a Biosolids Master Plan Study in 2013 to evaluate alternatives for biosolids handling, treatment, stabilization and disposal.

The 2013 Biosolids Master Plan was followed by a detailed study and report of alternatives titled Biosolids Processing Facilities Improvements Preliminary Engineering Report, November 2014. The report recommended replacing the RDP advanced alkaline (lime) stabilization process with anaerobic digestion and direct heat drying processes (AD+HD) to "...reduce the County's exposure to the risk of increasing and uncertain regulatory restrictions on bulk land application." The report also concluded that the AD+HD processes represent "...the most cost-effective alternative, using proven and reliable technology, for meeting the County's objectives for volume reduction and a versatile, high-quality product with a variety of potential beneficial uses."

- B. Chemical Additives: Lime, Polymers. Sodium Hypochlorite is used for odor control.

C. Solids Content (After Dewatering):

1. Current Operations produce a sludge filter cake with average 40% total solids content by weight following dewatering and the addition of lime.
2. Future Operations- The proposed AD+HD processes will produce a dried uniform granular product (pellets) with average 92% total solids content by weight.

D. Disposal/Utilization Methods

1. Current Operations- The RDP process mixes incoming, dewatered sludge with lime and provides supplemental heat to raise the temperature of the sludge/lime mix to 160 degrees F. The sludge then travels for 30 minutes through an oven prior to discharge to a transport vehicle. The process achieves complete pasteurization of the sludge producing Class A/EQ product suitable for marketing and general distribution.

The County utilizes a sludge disposal contractor to haul and dispose of all sludge produced at the Little Patuxent Plant. The contractor is responsible for locating suitable sites and obtaining all required transport and application permits for land applying the hauled sludge. The County may, at its option, require or allow the contractor to haul sludge to the County's Alpha Ridge landfill for disposal or land-spreading. The contractor is required to produce Class A biosolids and to develop and maintain a marketing and distribution system.

2. Future Operations- The implementation of the proposed anaerobic digestion and heat drying processes will provide the following operational changes:
 - Primary and waste activated sludges will be thickened using gravity thickeners.
 - The thickened sludge will be pumped to new high-rate mesophilic anaerobic digestion reactors.
 - Digested solids will be pumped from the Digested Solids Storage Tanks to the centrifuges for dewatering, thereby increasing the solids content of the sludge from approximately 4% to 20% total solids content by weight.
 - The dewatered sludge cake will be conveyed to two new belt dryers utilizing natural gas and digester gas fuels to heat and dry the sludge, producing a granular product with approximately 92% total solids.

- Dried biosolids will be conveyed by pneumatic or drag-tube conveyor system to two elevated, bolted steel storage silos with hopper bottoms for drive-through truck loading directly beneath each silo.
- The new AD+HD processes will produce a Class A/EQ sludge product with greater flexibility for agricultural land application, and increased compatibility with numerous markets that are not currently available to the County including, but not limited to: turf production, fertilizer blending, commercial nursery applications, ornamental and landscaping applications, biofuel and soil manufacturing. Following implementation of the new biosolids processing facilities, the County may contract with one or more sludge disposal contractors to haul and dispose of all sludge produced at the Little Patuxent Plant. The contractor responsibilities will include locating sites for land spreading the hauled sludge.

TABLE 17
SEWER PUMPING STATIONS

Facility Name	Road Location	ADC Map Coordinates	Existing Design Capacity ADF (MGD)	Current Average Day Flow, ADF (MGD) ⁽¹⁾
ALLENFORD	10071 Green Clover	11H-2	0.810	0.111
ANNAPOLIS JUNCTION	8970 Henkels	20G-10	0.280	0.016
AUTUMN RIVER	5208 Bending Sky Way	12H-11	0.033	0.000
CHAMBERLEA	2835 Thornbrook	11K-1	0.600	0.076
CHERRY CREEK	11024 Scotts Landing	19B-7	0.140	0.034
CHERRY TREE FARMS	8409 Sweet Cherry Lane	19B-7	0.860	0.101
CHURCH AVE	2097 Church Ave	17K-7	0.100	0.000
COLLEGE AVE	College Ave	12H-12	0.300	0.061
DORSEY RUN	8181 Patuxent Range Rd	16H-6	3.500	1.147
FOREST HILL DRIVE	8100 Forest Hill Drive	12H-5	0.140	0.007
HOBSONS CHOICE	10169 Hobsons Choice Lane	11G-1	0.110	0.001
HOLLIFIELD	2250 River Terrace Ct	12G-1	0.180	0.017
ICE CRYSTAL DRIVE	8535 Ice Crystal Drive	19A-6	0.170	0.011
KERGER ROAD ⁽²⁾	5357 Sunnyfield Ct	16K-5	0.720	0.000
NORTH LAUREL	US Rt 1 and Patuxent River	19K-14	2.880	1.013
MEADOWRIDGE	7304 Meadowridge Rd	17A-11	1.010	0.016
MOUNT HEBRON	9358 Furrow Ave	12B-1	0.680	0.105
NEW CUT ROAD	4747 New Cut	12F-12	0.520	0.053
NOTTINGHAM	7902 Nottingham	16H-1	ABANDONED	
OLD FREDERICK RD	8598 Old Frederick	12D-2	0.470	0.083
OLD LANDING RD	5780 Old Landing	17D-6	0.140	0.559
PATAPSCO	2206 Mt Hebron	12B-2	0.860	0.121
PINE VALLEY	10812 Harding	19C-8	0.170	0.005
RESERVOIR OVERLOOK	11300 Windsor Walk Way	19A-8	0.260	0.031
ROCKBURN	5390 Landing Road	17B-5	1.400	0.298

TABLE 17
SEWER PUMPING STATIONS

Facility Name	Road Location	ADC Map Coordinates	Existing Design Capacity ADF (MGD)	Current Average Day Flow, ADF (MGD) ⁽¹⁾
ROUTE 40	US Rt 40 between St. Johns Lane and Chatham Rd	12B-7	1.010	0.254
ROUTE 108	4820 Woodland	15J-1	6.370	0.009
TOWER ACRES	10161 Bond Mill	19D-8	0.190	0.036
VALLEY LANE	8101 Valley Lane	12G-5	0.140	0.004
WAVERLY	15599 Dorchester	11F-1	0.900	1.054
WILLOWS	8567 Willow Wisp	19C-7	0.140	0.016
FUTURE PUMPING STATIONS				
DANIELS (2) STATIONS		12F-2		
COLLEGE AVE (2) STATIONS		12H-11		
ROCKY GORGE (2) STATIONS		18K-8		
CHURCH LANE		12F-4		
ILCHESTER ROAD		11F-5		
LAWYERS HILL (2) STATIONS		17H-5		

Notes:

(1) FY2013 flows

(2) Currently out of Service, flows captured by Rockburn SPS

TABLE 18
IMMEDIATE, 5-YEAR, 10-YEAR, AND COMPREHENSIVE PRIORITIES FOR RECLAIMED WATER SYSTEM DEVELOPMENT

Capital Project Number	County Priority Assigned	Coordinate Location	Description	Project Costs (\$)			Project Schedule		
				Total	PL660 Eligibility	Local	Preliminary Plans	Start Construction	Complete Construction
W-8323	Under Const.		Design and Construction of diversion structure, pumping station, elevated storage tank and reclaimed water lines to supply Fort Meade with reclaimed water.	55,000,000				2014	2016
W-8325	0 - 5 Years		LP WRP to Guilford RWST Reclaimed Water Main and conversion of existing Guilford Water Storage Tank to a reclaimed tank	8,465,000			2015	2016	2019
	6 - 10 Years		US Route 1 Reclaimed Water Main						
	6 - 10 Years		MD Route 216 Reclaimed Water Main						
	6 - 10 Years		MD Route 216 Reclaimed Water Pumping Station						
	6 - 10 Years		MD Route 216 Reclaimed Water Storage Tank						
	6 - 10 Years		MD Route 175 Reclaimed Water Main						
	6 - 10 Years		MD Route 175 Reclaimed Water Pumping Station						
	6 - 10 Years		MD Route 175 Reclaimed Water Storage Tank						
	6 - 10 Years		Old Columbia Road / Shaker Drive Reclaimed Water Main						
	Comprehensive		Gerwig Lane / Guilford Road Reclaimed Water Main						
	Comprehensive		Gerwig Lane to Route 103 Reclaimed Water Main						
	Comprehensive		Hammond Branch Reclaimed Water Main						
	Comprehensive		Hammond Branch Reclaimed Water Pumping Station						
	Comprehensive		Hammond Branch Reclaimed Water Storage Tank						
	Comprehensive		Cedar Lane Reclaimed Water Main						
	Comprehensive		Cedar Lane Reclaimed Water Pumping Station						
	Comprehensive		Cedar Lane Reclaimed Water Storage Tank						
	Comprehensive		US Route 1 Reclaimed Water Main						
	Comprehensive		MD Route 103 Reclaimed Water Main						
	Comprehensive		MD Route 103 Reclaimed Water Pumping Station						
	Comprehensive		MD Route 103 Reclaimed Water Storage Tank						
	Comprehensive		Shaker Drive Reclaimed Water Main						
	Comprehensive		Bethany Lane / US Route 40 / Frederick Road Reclaimed Water Main						
	Comprehensive		US Route 40 Reclaimed Water Pumping Station						
	Comprehensive		Bethany Lane Reclaimed Water Storage Tank						
	Comprehensive		I-70 Reclaimed Water Main						
	Comprehensive		I-70 Reclaimed Water Pumping Station						
	Comprehensive		I-70 Reclaimed Water Storage Tank						

	In Progress
	0 - 5 Years
	6 - 10 Years
	Beyond 10 Years

LP WRP - Little Patuxent Water Reclamation Plant
RWST - Reclaimed Water Storage Tank
RWPS - Reclaimed Water Pumping Station

Little Patuxent Water Reclamation Plant- Flow Schematic

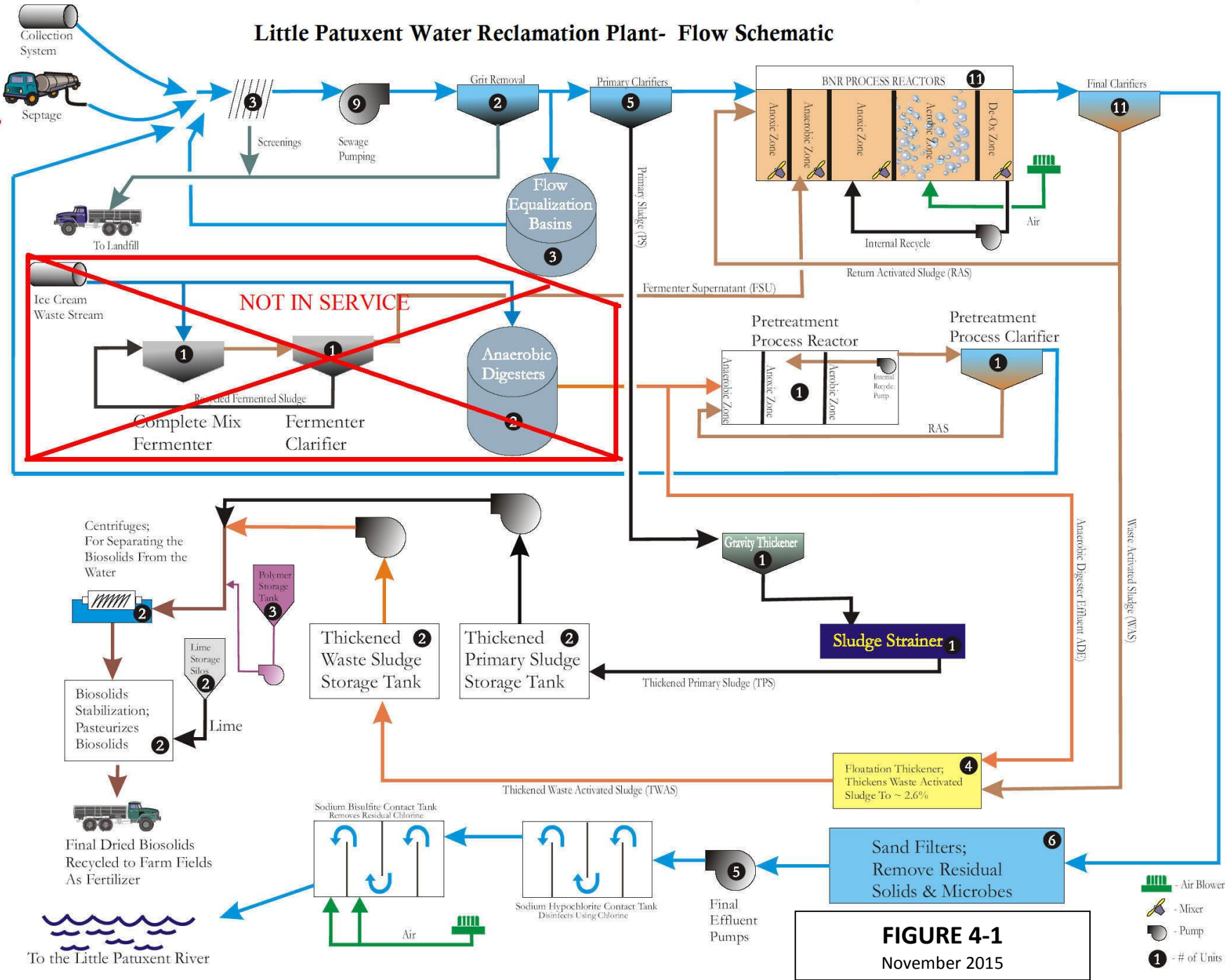

FIGURE 4-1
 November 2015

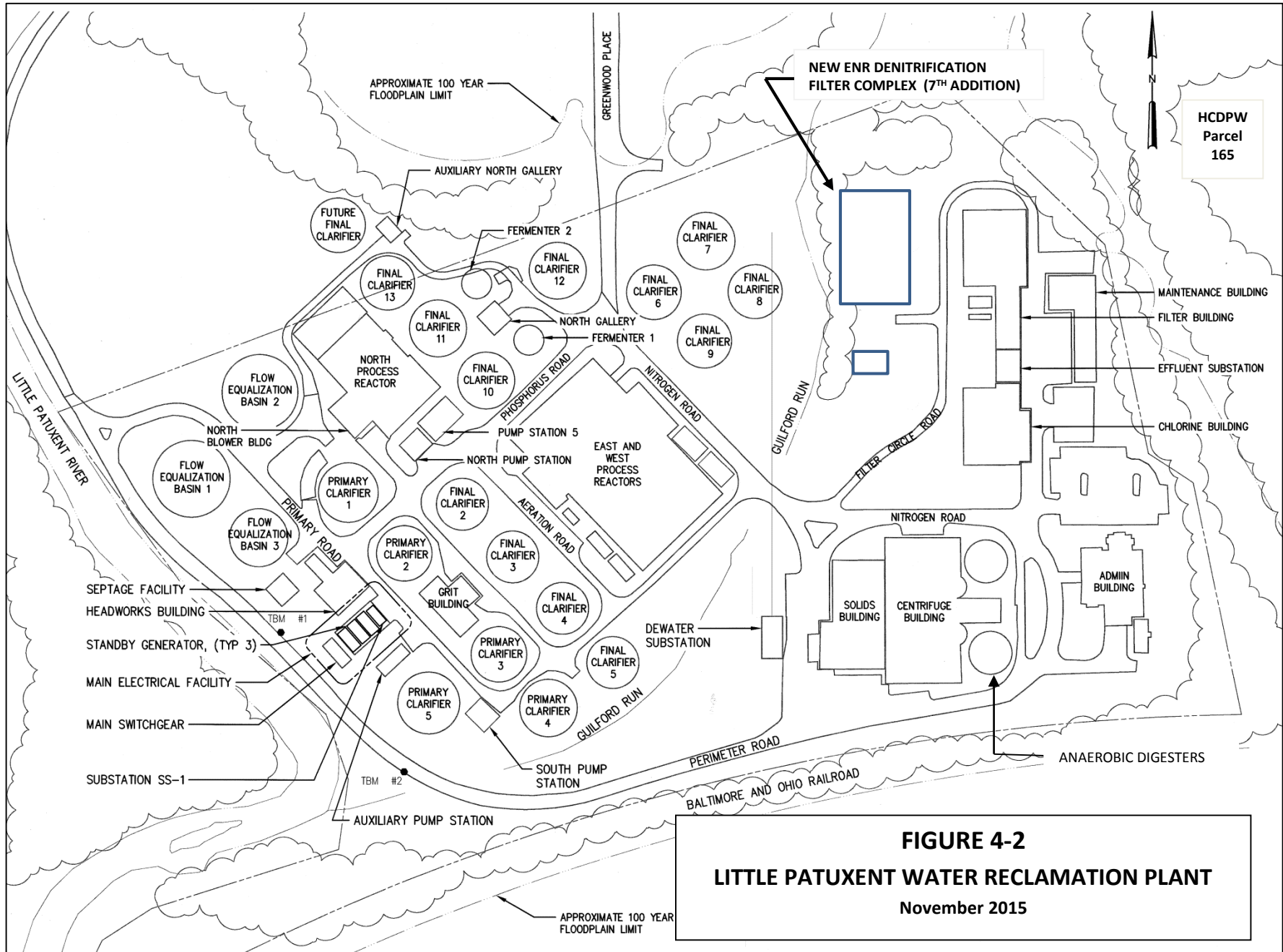

FIGURE 4-2
LITTLE PATUXENT WATER RECLAMATION PLANT
 November 2015

Sewer Facilities

- Existing Force Main
- Existing Sewer Line
- Existing Pump Station
- Planned Pump Station
- Existing Treatment Plant
- Existing but Decommissioned Treatment Plant

Improvements

- Scheduled Improvements
- 0 - 5 years (2014)
- Comprehensive Improvements (2040)

PATUXENT SUBDRAINAGE AREAS

DR	DORSEY RUN PUMPING STATION
GR1	GUILFORD RUN (LP WRP)
GR2	GUILFORD RUN (ANNAPOLIS JUNCTION)
HB1	HAMMOND BRANCH (LP WRP)
HB2	HAMMOND BRANCH (U.S. ROUTE 1)
HB3	HAMMOND BRANCH (BURSA ROAD)
LP1	LITTLE PATUXENT (LP WRP)
LP2	LITTLE PATUXENT
MP	MIDDLE PATUXENT
NL1	NORTH LAUREL PUMPING STATION
PS1	ROUTE 108 PUMPING STATION (BYPASS)
RB	ROCKBURN PUMPING STATION

PATAPSCO SUBDRAINAGE AREAS

BB1	BONNIE BRANCH (METER)
BB2	BONNIE BRANCH (KERGER ROAD P.S.)
D	DANIELS(S)
DP1	DEEP RUN (METER)
DP11	DEEP RUN (U.S. ROUTE 1)
DP2	DEEP RUN (ELKRIDGE)
DP3	DEEP RUN (HANOVER ROAD)
DP5	DEEP RUN (B&O RAILROAD)
DP8	DEEP RUN (DORSEY ROAD)
EC	TIBER BRANCH (MAIN ST. METER)
SB1	SUCKER BRANCH (METER)
SB2	SUCKER BRANCH (NORMANDY)

#. Pumping Station/Treatment Plant

1.	ALLENFORD	23.	KERGER ROAD
2.	ANNAPOLIS JUNCTION	24.	LAWYER HILL (1)
3.	AUTUMN RIVER	25.	LAWYER HILL (2)
4.	CHAMBERLEA	26.	LITTLE PATUXENT WRP
5.	CHERRY CREEK	27.	MEADOWRIDGE ROAD
6.	CHERRY TREE FARMS	28.	MT. HEBRON
7.	CHURCH AVE	29.	NEW CUT ROAD
8.	CHURCH LANE	30.	NORTH LAUREL
9.	COLLEGE AVE	31.	NOTTINGHAM WAY
10.	COLLEGE AVE (1)	32.	OLD FREDERICK ROAD
11.	COLLEGE AVE (2)	33.	OLD LANDING
12.	DANIELS (1)	34.	PATAPSCO
13.	DANIELS (2)	35.	PINE VALLEY
14.	DANIELS (3)	36.	RESERVOIR OVERLOOK
15.	DEEP RUN (1)	37.	ROCKBURN
16.	DEEP RUN (2)	38.	ROUTE 108
17.	DORSEY RUN	39.	ROUTE 40
18.	FOREST HILL	40.	TOWER ACRES
19.	HOBSONS CHOICE	41.	VALLEY LANE
20.	HOLLIFIELD	42.	WAVERLY
21.	ICE CRYSTAL	43.	WILLOWS
22.	ILCHESTER		

Capital Projects Key (Refer to Table 13)

A)	S-6271	G)	S-6284
B)	S-6274	H)	S-6285
C)	S-6280	I)	FUTURE
D)	S-6281	J)	FUTURE
E)	S-6282	K)	FUTURE
F)	S-6283	L)	FUTURE

FIGURE 4-3
Immediate, 5-Year, 10-Year and Comprehensive Priorities Plan for Sewer System Development
 November 2015

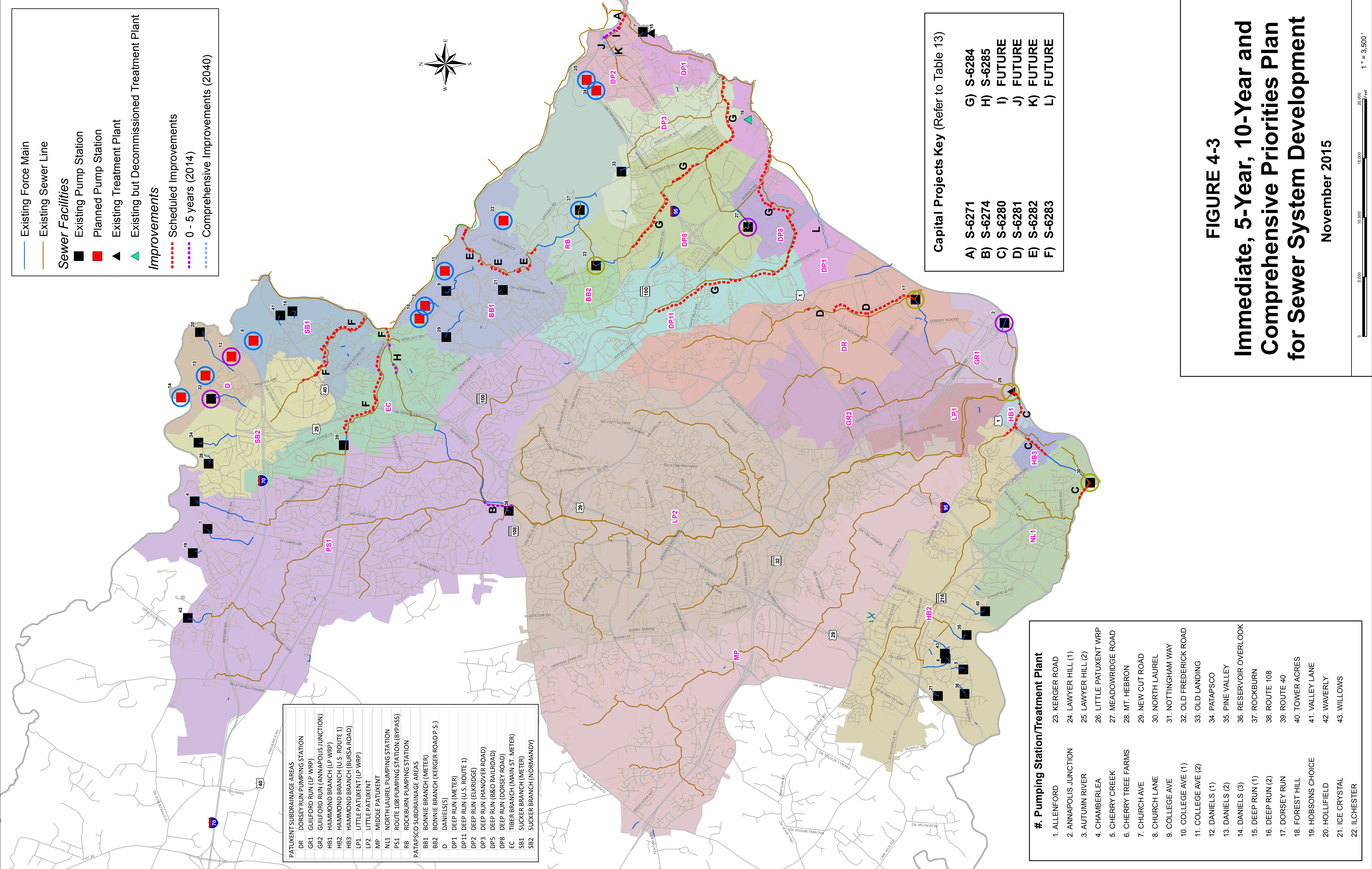
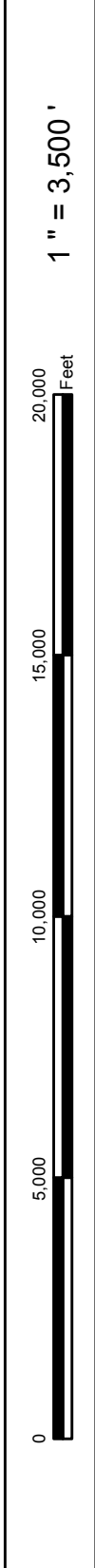

EXHIBITS

- 1 WATER FACILITIES PLAN Map and Table of Service Priority Revisions
2011-2014
- 2 SEWER FACILITIES PLAN Map and Table of Service Priority Revisions
2011-2014
- 3 1986 Baltimore City Water – Howard County Water Agreement
- 4 1988 WSSC – Howard County Water Agreement
- 5 2014 Water Quality Report and Sampling Data
- 6 Baltimore County – Howard County Sewer Agreements
- 7 Anne Arundel – Howard County Sewer Agreements
- 8 Patapsco Service Area Memorandum of Understanding
- 9 NPDES LPWRP Discharge Permit
- 10 Water Resources Element, April 2010
- 11 Reclaimed Water Management (RWM) Plan
- 12 Howard County Topography Maps
- 13 Howard County General Plan Map

EXHIBIT 1

**Table of Water Service Priority
Revisions 2011- 2014
&
2015 Water Facilities Plan Map**

EXHIBIT 1- WATER FACILITIES PLAN MAP UPDATES

Revisions to Water Service Categories for Subdivision Activity from 2011 through December 2014.

MAP ID	TAX MAP	SUBDIVISION OR OWNER NAME	SECTION/AREA/BLOCK/PARCEL/LOTS	PROPOSED REVISION	REVISION JUSTIFICATION
W-01	MAP 16, GRID 24; MAP 23, GRID 6-18	WESTMOUNT SUBDIVISION; PART OF DOUGHOREGAN PROPERTY	221 ACRES PART OF PARCEL 71, LOT PAR 3	ADDITION OF PARCEL TO WATER & SEWER PSA	HOWARD COUNTY COUNCIL BILL 9-2010
W-02	34, GRID 18	CLARKSVILLE PIKE & GUILFORD ROAD: HODDINOTT PROPERTY & OTHERS	FOUR PARCELS TOTALING 93.3 AC: HODDINOTT P 88; HIGGS PROPERTY P 162; CLARKSVILLE PROF CENTER P 426	ADDITION OF PARCELS TO WATER & SEWER PSA; 6-TO-10 YEAR SERVICE CATEGORY	PLANHOWARD 2030, CHAPTER 6
W-03	46, GRID 02	MAPLE LAWN FARMS, FULTON MD	PARCEL 113- 91.25 ACRES	ADDITION OF PARCEL TO WATER & SEWER PSA; 6-TO-10 YEAR SERVICE CATEGORY	PLANHOWARD 2030, CHAPTER 6
W-04	31, GRID 17	MCCARTHY PROPERTY	5041 LANDING ROAD; PARCEL 608	ENTERED METRO DISTRICT	METRO DISTRICT DECISION NO. 01-2011
W-05	31, GRID 16	ANDERSON PROPERTY	5211 TALBOTS LANDING; PARCEL 707, P/O LOT 12D	ENTERED METRO DISTRICT	METRO DISTRICT DECISION NO. 08-2011
W-06	35, GRID 2	TAJ PROPERTY	5644 TROTTER ROAD; PARCEL 5, LOT 1	ENTERED METRO DISTRICT	METRO DISTRICT DECISION NO. 09-2011
W-07	41, GRID 6	HUFFMAN PROPERTY	10606 VISTA ROAD; PARCEL 220, LOT 33	ENTERED METRO DISTRICT	METRO DISTRICT DECISION NO. 01-2012
W-08	35, GRID 2	TROTTER POINT, LLC	5770 & 5790 TROTTER ROAD; PARCEL 8, LOT 15	ENTERED METRO DISTRICT	METRO DISTRICT DECISION NO. 02-2012
W-09	42, GRID 7	KINGS COVE HOA, INC.	8509 GUILFORD ROAD; PARCEL 61, P/O LOT 4	ENTERED METRO DISTRICT	METRO DISTRICT DECISION NO. 03-2012

EXHIBIT 1- WATER FACILITIES PLAN MAP UPDATES

Revisions to Water Service Categories for Subdivision Activity from 2011 through December 2014.

MAP ID	TAX MAP N	SUBDIVISION OR OWNER NAME	SECTION/AREA/BLOCK/ PARCEL/LOTS	PROPOSED REVISION	REVISION JUSTIFICATION
W-10	35, GRID 2	TROTTER CROSSING LLC	5674, 5680 & 5686 TROTTER ROAD; 11712 & 11716 TROTTER CROSSING LANE; PARCEL 481	ENTERED METRO DISTRICT	METRO DISTRICT DECISION NO. 04-2012
W-11	31, GRID 16	TURLEY PROPERTY; TURLEY'S OVERLOOK	SOUTH ILCHESTER ROAD AT TALBOTS LANDING; PARCEL 739, LOT 02	ENTERED METRO DISTRICT	METRO DISTRICT DECISION NO. 05-2012
W-12	41, GRID 6	LEE PROPERTY	10718 HUNTING LANE; PARCEL 252, LOT 69	ENTERED METRO DISTRICT	METRO DISTRICT DECISION NO. 06-2012
W-13	29, GRID 20	SAMUEL & AMBILY PROPERTY	5517 TROTTER ROAD; PARCEL 88, LOT 4	ENTERED METRO DISTRICT	METRO DISTRICT DECISION NO. 01-2013
W-14	41, GRID 6	FEDAK & PETRY PROPERTY	10710 HUNTING LANE; PARCEL 174, LOT 15	ENTERED METRO DISTRICT	METRO DISTRICT DECISION NO. 02-2013
W-15	41, GRID 11	SCHARNHORST PROPERTY	10734 JUDY LANE; PARCEL 420, LOT 3	ENTERED METRO DISTRICT	METRO DISTRICT DECISION NO. 03-2013
W-16	35, GRID 17	HAGOOD PROPERTY	10829 BRAEBURN ROAD; PARCEL 228, LOT 34	ENTERED METRO DISTRICT	METRO DISTRICT DECISION NO. 04-2013
W-17	35, GRID 24	PANDEY & KAPADIA PROPERTY	8030 HARRIET TUBMAN LANE; PARCEL 129	ENTERED METRO DISTRICT	METRO DISTRICT DECISION NO. 05-2013
W-18	35, GRID 17	CORNERSTONE HOLDINGS LLC	10879, 10883 & 10887 HARMEL DRIVE; PARCEL 101, LOTS 1-3	ENTERED METRO DISTRICT	METRO DISTRICT DECISION NO. 06-2013
W-19	35, GRID 8	EMERY & GAJEWSKI PROPERTY	6301 TROTTER ROAD; PARCEL 66	ENTERED METRO DISTRICT	METRO DISTRICT DECISION NO. 07-2013
W-20	41, GRID 12	JACOBS PROPERTY	10709 JUDY LANE; PARCEL 253, LOT 18	ENTERED METRO DISTRICT	METRO DISTRICT DECISION NO. 08-2013
W-21	35, GRID 8	RISTWAY PROPERTY	5946 TROTTER ROAD; PARCEL 373, LOT 6	ENTERED METRO DISTRICT	METRO DISTRICT DECISION NO. 09-2013

EXHIBIT 1- WATER FACILITIES PLAN MAP UPDATES

Revisions to Water Service Categories for Subdivision Activity from 2011 through December 2014.

MAP ID	TAX MAP	SUBDIVISION OR OWNER NAME	SECTION/AREA/ BLOCK/ PARCEL/LOTS	PROPOSED REVISION	REVISION JUSTIFICATION
W-22	31, GRID 10	CASCADE WALTHUR LLC	4806, 4810, 4814 & 4822 WELLSTONE WAY; PARCEL 133, LOTS 4-11-	ENTERED METRO DISTRICT	METRO DISTRICT DECISION NO. 10-2013
W-23	31, GRID 10	WILLIAMSBURG GROUP LLC	4811, 4818 & 4819 WELLSTONE WAY; PARCEL 133, LOTS 1-3	ENTERED METRO DISTRICT	METRO DISTRICT DECISION NO. 11-2013
W-24	31, GRID 10	CASCADE OVERLOOK 4 HOA	WELLSTONE WAY OPEN SPACE LOT 08	ENTERED METRO DISTRICT	METRO DISTRICT DECISION NO. 12-2013
W-25	31, GRID 24	GELHAAR PROPERTY	5295 LANDING ROAD; PARCEL 619, LOT 3	ENTERED METRO DISTRICT	METRO DISTRICT DECISION NO. 01-2014
W-26	47, GRID 3	BEAZER HOMES CORP	10010 GORMAN ROAD; PARCEL 472	ENTERED METRO DISTRICT	METRO DISTRICT DECISION NO. 02-2014
W-27	10, GRID 13	DORSEY FAMILY HOMES, INC.	1670 HENRYTON ROAD; PARCEL 184	ENTERED METRO DISTRICT	METRO DISTRICT DECISION NO. 03-2014
W-28	35, GRID 8	SARY PROPERTY	5960 TROTTER ROAD; PARCEL 163	ENTERED METRO DISTRICT	METRO DISTRICT DECISION NO. 04-2014
W-29	34, GRID 18	ISICOFF PROPERTY	6215 GUILFORD ROAD; PARCEL 163	ENTERED METRO DISTRICT	METRO DISTRICT DECISION NO. 05-2014
W-30	41, GRID 5	SD PROPERTIES LLC	10821 HUNTING LANE; PARCEL 273, LOT 54	ENTERED METRO DISTRICT	METRO DISTRICT DECISION NO. 06-2014
W-31	34, GRID 12	HO PROPERTY	6118 TULANE DRIVE; PARCEL 123	ENTERED METRO DISTRICT	METRO DISTRICT DECISION NO. 07-2014
W-32	37, GRID 5	ROCK BURN LLC	MONTERY ROAD; PARCEL 52, P/O PARCEL A	ENTERED METRO DISTRICT	METRO DISTRICT DECISION NO. 08-2014
W-33	35, GRID 23	PASS PROPERTY	7831 HARRIET TUBMAN LANE; PARCEL 117	ENTERED METRO DISTRICT	METRO DISTRICT DECISION NO. 09-2014
W-34	37, GRID 20	SADEGHI-BAJGIRAN PROPERTY	NORTH LARK BROWN ROAD; PARCEL 508	ENTERED METRO DISTRICT	METRO DISTRICT DECISION NO. 10-2014

EXHIBIT 1- WATER FACILITIES PLAN MAP UPDATES

Revisions to Water Service Categories for Subdivision Activity from 2011 through December 2014.

MAP ID	TAX MAP	SUBDIVISION OR OWNER NAME	SECTION/AREA/BLOCK/ PARCEL/LOTS	PROPOSED REVISION	REVISION JUSTIFICATION
W-35	16, GRID 14	ARAGHI & ANSARI PROPERTY	2840 KINGS GIFT DRIVE; PARCEL 367, LOT 50	ENTERED METRO DISTRICT	METRO DISTRICT DECISION NO. 11- 2014
W-36	35, GRID 23	ARMSTRONG & RINALDI PROPERTY	7938 HARRIET TUBMAN LANE; PARCEL 321	ENTERED METRO DISTRICT	METRO DISTRICT DECISION NO. 12- 2014
W-37	23, GRID 10	CARROLL PROPERTY	FREDERICK ROAD; PARCEL 149, LOT 1	ENTERED METRO DISTRICT	METRO DISTRICT DECISION NO. 13- 2014
W-38	23, GRID 10	CARROLL PROPERTY	10575 FREDERICK ROAD; PARCEL 149, LOT PARCEL A	ENTERED METRO DISTRICT	METRO DISTRICT DECISION NO. 14- 2014
W-39	18, GRID 01	PHELPS PROPERTY	PARCEL 357, LOT 2; 3.41 ACRES	CHANGE 0-TO-5 YEARS TO EXISTING	F-14-042 FINAL PLAN RECORDED
W-40	17, GRID 16	MT. HEBRON OVERLOOK; LOTS 1-25	PARCEL 416	CHANGE 6-TO-10 YEARS TO EXISTING	F-11-064 FINAL PLAN SUBMITTED
W-41	25, GRID 01	ALTA AT REGENCY CREST	PARCEL 01, LOT PARCEL A; 5.8 ACRES	CHANGE 0-TO-5 YEARS TO EXISTING	F-08-165 FINAL PLAN RECORDED
W-42	24, GRID 01	TOWNS AT PATUXENT ORCHARD	PARCEL 647, LOT 2; 5.08 ACRES	CHANGE 0-TO-5 YEARS TO EXISTING	F-13-078 FINAL PLAN RECORDED
W-43	23, GRID 10	WESTMOUNT SUBDIVISION	PARCEL 149, LOT 1 & LOT PAR A	CHANGE NO PLANNED SERVICE TO 6-TO-10 YEARS	SP-14-008 PLAN SUBMITTED
W-44	24, GRID 09	LUTHERAN VILLAGE AT MILLER'S GRANT	PARCEL 1001; 49.68 ACRES	CHANGE 0-TO-5 YEARS TO EXISTING	F-10-083 FINAL PLAN RECORDED
W-45	25, GRID 14	AUTUMN OVERLOOK	PARCEL 0095	CHANGE 0-TO-5 YEARS TO EXISTING	F-13-081 FINAL PLAN RECORDED
W-46	25, GRID 14	AUTUMN RIVER PHASE 3	PARCEL 279, LOT 108 PARCEL 0172; LOTS 69-108	CHANGE 0-TO-5 YEARS TO EXISTING	F-10-067 FINAL PLAN RECORDED
W-47	31, GRID 04	LOCUST CHAPEL & LOCUST CHAPEL SEC 01	PARCEL 115, LOTS 1- 69	CHANGE 0-TO-5 YEARS TO EXISTING	F-12-009 FINAL PLAN RECORDED
W-48	30, GRID 02	CENTENNIAL LAKE OVERLOOK SEC 01 & 02	PARCEL 086, PAR A & B	CHANGE 0-TO-5 YEARS TO EXISTING	F-14-002 FINAL PLAN RECORDED
W-49	31, GRID 10	CASCADE OVERLOOK SEC 04	PARCEL 133, LOTS 1- 10	CHANGE 0-TO-5 YEARS TO EXISTING	F-12-074 AND F-12- 075 FINAL PLANS RECORDED

EXHIBIT 1- WATER FACILITIES PLAN MAP UPDATES

Revisions to Water Service Categories for Subdivision Activity from 2011 through December 2014.

MAP ID	TAX MAP	SUBDIVISION OR OWNER NAME	SECTION/AREA/BLOCK/ PARCEL/LOTS	PROPOSED REVISION	REVISION JUSTIFICATION
W-50	31, GRID 16	TURLEY'S MEADOW AND TURLEY'S OVERLOOK	PARCEL 738, LOTS 1-4	CHANGE 0-TO-5 YEARS TO EXISTING	F-13-084 AND F-14- 079 FINAL PLANS RECORDED
W-51	41, GRID 21	ENCLAVE AT PARK FOREST	PARCEL 516, UNITS 1- 45	CHANGE 0-TO-5 YEARS TO EXISTING	F-14-129 FINAL PLAN RECORDED
W-52	38, GRID 03	CYPRESS SPRINGS	PARCEL 46, LOTS 1-17	CHANGE 0-TO-5 YEARS TO EXISTING	F-10-028 FINAL PLAN RECORDED
W-53	37, GRID 10	THE WELLNESS CENTER OF HOWARD COUNTY	PARCEL 687, LOT E-1	CHANGE 0-TO-5 YEARS TO EXISTING	F-14-107 FINAL PLAN RECORDED
W-54	37, GRID 03	FOX HUNT ESTATES	PARCEL 606, LOTS 36	CHANGE 0-TO-5 YEARS TO EXISTING	F-13-016 FINAL PLAN RECORDED
W-55	35, GRID 02	TROTTER POINT	PARCELS 8, 9, 165; LOTS 15	CHANGE 0-TO-5 YEARS TO EXISTING	F-13-004 FINAL PLAN RECORDED
W-56	34, GRID 18	ENCLAVE AT TIERNEY FARM	PARCEL 88; 89.95 ACRES	CHANGE NO PLANNED SERVICE TO 6-TO-10 YEARS	ECP-15-005 PLAN SUBMITTED
W-57	41, GRID 22 & 46, GRID 03	MAPLE LAWN FARMS	PARCEL 124; LOTS C- 28, C-29 & OS LOT 03	CHANGE 0-TO-5 YEARS TO EXISTING	F-12-086 FINAL PLAN RECORDED
W-58	46, GRID 03	MAPLE LAWN FARMS	PARCEL 124; NON-B PAR C-27 WEST DIST PAR P	CHANGE 0-TO-5 YEARS TO EXISTING	F-12-015 FINAL PLAN RECORDED
W-59	46, GRID 11	RESERVOIR ESTATES (HIGDON PROPERTY)	PARCEL 56, LOTS 1-26	CHANGE 0-TO-5 YEARS TO EXISTING	F-14-003 FINAL PLAN RECORDED
W-60	42, GRID 21 47, GRID 2	WINCOPIA FARMS	PARCEL 472127.6 ACRES	CHANGE 6-TO-10 YEARS TO EXISTING	F-13-003 FINAL PLAN RECORDED
W-61	47, GRIDS 2-8	WALDEN WOODS	PARCEL 4, LOTS 98	CHANGE 0-TO-5 YEARS TO EXISTING	F-13-032 FINAL PLAN RECORDED
W-62	47, GRID 06	NORDAU SUBDIVISION	PARCEL 668, SEC E-1, LOTS 13-18	CHANGE 0-TO-5 YEARS TO EXISTING	F-12-047 FINAL PLAN RECORDED
W-63	43, GRID 19	CHASE LAND SUBDIVISION	PARCEL 235, LOT 2; 23.2 ACRES	CHANGE 0-TO-5 YEARS TO EXISTING	F-09-071 FINAL PLAN RECORDED

EXHIBIT 1- WATER FACILITIES PLAN MAP UPDATES

Revisions to Water Service Categories for Subdivision Activity from 2011 through December 2014.

MAP ID	TAX MAP	SUBDIVISION OR OWNER NAME	SECTION/AREA/ BLOCK/ PARCEL/LOTS	PROPOSED REVISION	REVISION JUSTIFICATION
W-64	37, GRID 16-22	THE MEADOWS CORPORATE PARK	PARCEL 173, LOT A-6; 33.16 ACRES	CHANGE 0-TO-5 YEARS TO EXISTING	F-14-035 FINAL PLAN RECORDED
W-65	38, GRID 09	SHADY LANE CROSSING	PARCEL 235, LOTS 1- 25	CHANGE 0-TO-5 YEARS TO EXISTING	F-06-097 FINAL PLAN RECORDED
W-66	38, GRIDS 14-15	WINTER CREST	PARCEL 868, LOTS 1-8	CHANGE 0-TO-5 YEARS TO EXISTING	F-12-076 FINAL PLAN RECORDED
W-67	47, GRIDS 19-20; 50, GRIDS 1-2	HIGH RIDGE MEADOWS SEC 01 (DEER SPRINGS SEC 01)	PARCELS 363 & 542; LOT B; 36.94 ACRES	CHANGE 0-TO-5 YEARS TO EXISTING	F-14-022 FINAL PLAN RECORDED
W-68	41, GRIDS 5, 6 AND 11	RIVERSIDE ESTATES	VISTA ROAD, HUNTING LANE, JUDY LANE, NEWBERRY DRIVE, LONG VIEW ROAD, MOOSEBERGER CT AND CLEOS CT	CHANGE 0-TO-5 YEARS TO EXISTING	MAP CORRECTION
W-69	37, GRID 01	VILLAGE OF MONTGOMERY RUN	MONTGOMERY RUN ROAD	CHANGE 0-TO-5 YEARS TO EXISTING	MAP CORRECTION
W-70	24, GRID 06	HOWARD COUNTY HOUSING COMMISSION	8720 RIDGE ROAD; PARCEL 56, PAR B	CHANGE 0-TO-5 YEARS TO EXISTING	MAP CORRECTION
W-71	32, GRID 20	ROCKBURN LANDING AREA	6150-6400 ROCKBURN HILL ROAD & CROSSVIEW ROAD	CHANGE 0-TO-5 YEARS TO EXISTING	COMPLETED CONSTRUCTION OF WATER CONTRACT 14-4715
W-72	47, GRID 05	HOWARD COUNTY BOARD OF EDUCATION	PARCEL 25; PATUXENT VALLEY MS AND BOLLMAN BRIDGE ES	CHANGE 0-TO-5 YEARS TO EXISTING	MAP CORRECTION

EXHIBIT 1 HOWARD COUNTY MASTER PLAN FOR WATER AND SEWER WATER

NOVEMBER 2015

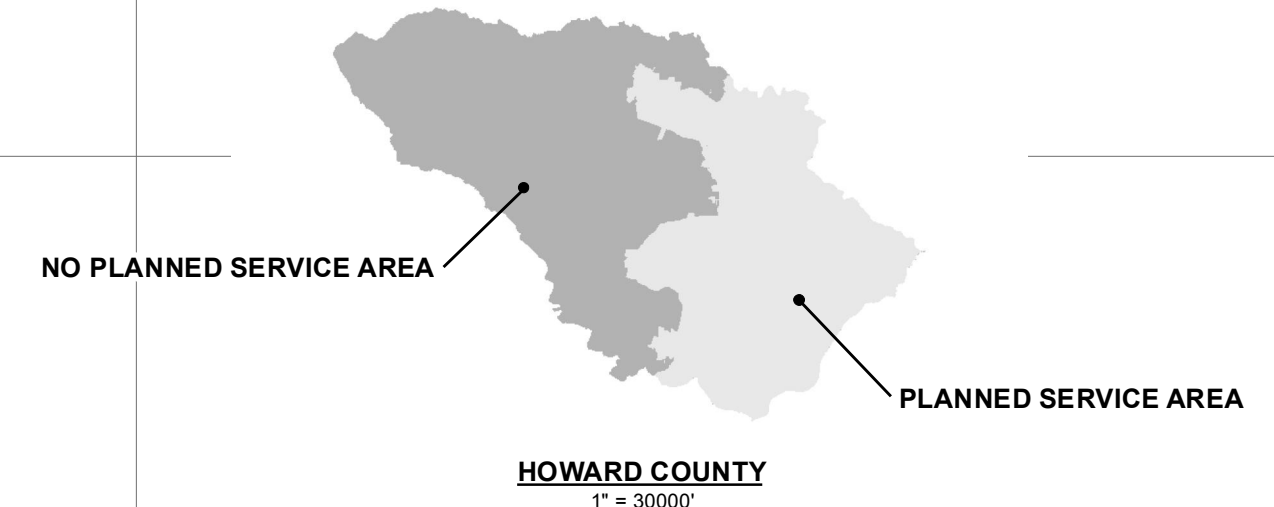
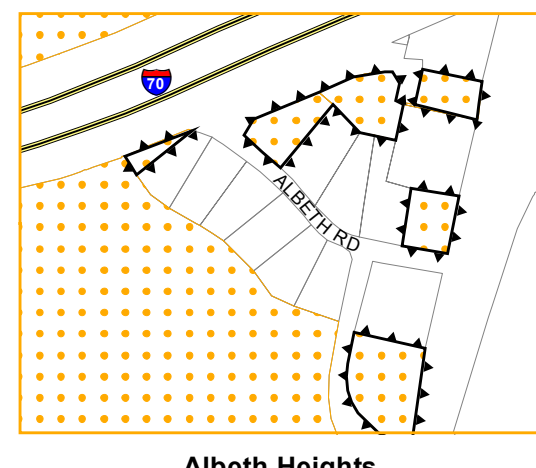

SERVICE AREAS*

- 0 to 5 Years
- 6 to 10 Years
- Comprehensive
- No Planned Service
- Park/Open Space
- Service Area Revisions since 2011
- *Areas not in any of the above categories are Existing/Under Construction
- Water Pressure Zone

FACILITIES

- | | EXISTING | PLANNED |
|-----------------------|----------|---------|
| Pump Station | | |
| Storage Facility | | |
| Water Main | | |
| Metropolitan District | | |

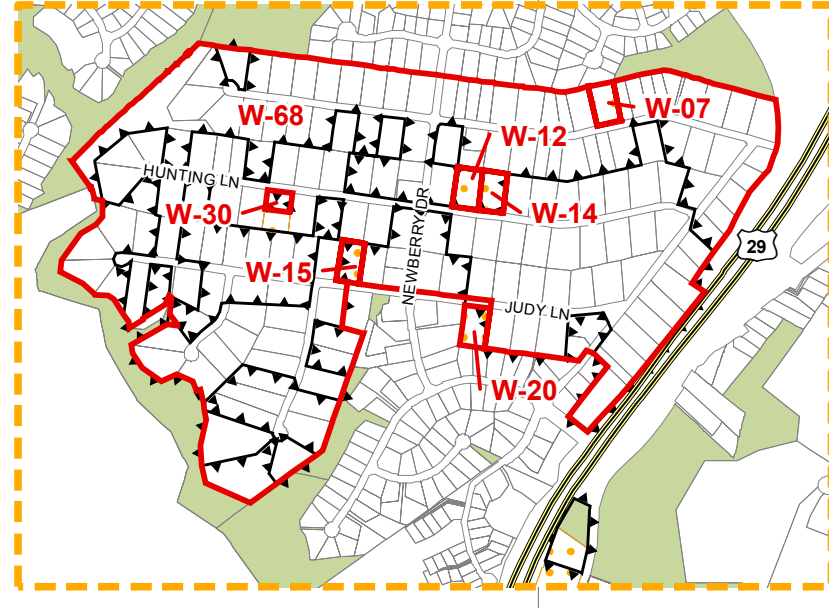
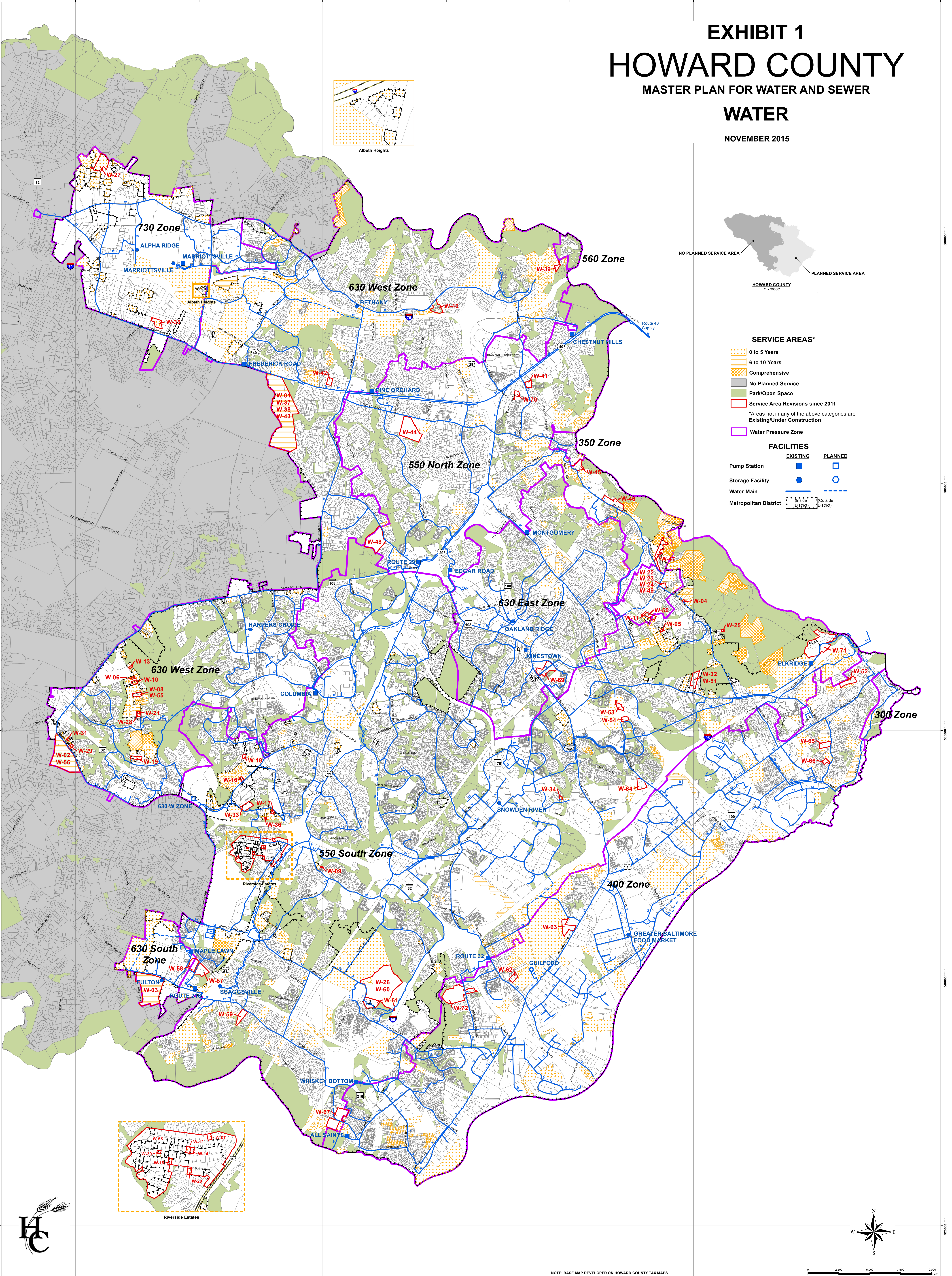

EXHIBIT 2

Table of Sewer Service Priority

Revisions 2011- 2014

&

2015 Sewer Facilities Plan Maps

East- Planned Service Area

West- No Planned Services Area

EXHIBIT 2- SEWER FACILITIES PLAN MAP UPDATES

Revisions to Sewer Service Categories for Subdivision Activity from 2011 through December 2014.

MAP ID	TAX MAP	SUBDIVISION OR OWNER NAME	SECTION/AREA/BLOCK/PARCEL/LOTS	PROPOSED REVISION	REVISION JUSTIFICATION
S-01	MAP 16, GRID 24; MAP 23, GRID 6-18	WESTMOUNT SUBDIVISION; PART OF DOUGHOREGAN PROPERTY	221 ACRES PART OF PARCEL 71, LOT PAR 3	ADDITION OF PARCEL TO WATER & SEWER PSA	HOWARD COUNTY COUNCIL BILL 9-2010
S-02	16, GRID 02	ALPHA RIDGE LANDFILL, HOWARD COUNTY MD	PARCEL 11, 239.78 AC	ADDITION OF PARCEL TO SEWER PSA; 6-TO-10 YEARS SERVICE CATEGORY	PLANHOWARD 2030, CHAPTER 6
S-03	16, GRID 22	BOARD OF EDUCATION; ELLICOTT MEADOWS; CADOGAN PROPERTY AND OTHERS	TWENTY PARCELS TOTALING 158.75 AC BD OF EDUCATION- P 203, 41.15 AC; ELLICOTT MEADOWS- P 446, 86 AC; CADOGAN PROPERTY- P 248, 15.8 AC	ADDITION OF PARCELS TO SEWER PSA; 6-TO-10 YEAR SERVICE CATEGORY	PLAN HOWARD 2030, CHAPTER 6; CAPITAL PROJECT S-6293
S-04	34, GRID 18	CLARKSVILLE PIKE & GUILFORD ROAD: HODDINOTT PROPERTY & OTHERS	FOUR PARCELS TOTALING 93.3 AC: HODDINOTT PARCEL 88; HIGGS PROPERTY PARCEL 162; CLARKSVILLE PROF CENTER PARCEL 426	ADDITION OF PARCELS TO WATER & SEWER PSA; 6-TO-10 YEAR SERVICE CATEGORY	PLANHOWARD 2030, CHAPTER 6
S-05	46, GRID 02	MAPLE LAWN FARMS, FULTON MD	PARCEL 113- 91.25 ACRES	ADDITION OF PARCEL TO WATER & SEWER PSA; 6-TO-10 YEAR SERVICE CATEGORY	PLANHOWARD 2030, CHAPTER 6
S-06	31, GRID 17	MCCARTHY PROPERTY	5041 LANDING ROAD; PARCEL 608	ENTERED METRO DISTRICT	METRO DISTRICT DECISION NO. 01-2011
S-07	31, GRID 16	ANDERSON PROPERTY	5211 TALBOTS LANDING; PARCEL 707, P/O LOT 12D	ENTERED METRO DISTRICT	METRO DISTRICT DECISION NO. 08-2011
S-08	35, GRID 2	TAJ PROPERTY	5644 TROTTER ROAD; PARCEL 5, LOT 1	ENTERED METRO DISTRICT	METRO DISTRICT DECISION NO. 09-2011
S-09	41, GRID 6	HUFFMAN PROPERTY	10606 VISTA ROAD; PARCEL 220, LOT 33	ENTERED METRO DISTRICT	METRO DISTRICT DECISION NO. 01-2012

EXHIBIT 2- SEWER FACILITIES PLAN MAP UPDATES

Revisions to Sewer Service Categories for Subdivision Activity from 2011 through December 2014.

MAP ID	TAX MAP N	SUBDIVISION OR OWNER NAME	SECTION/AREA/ BLOCK/ PARCEL/LOTS	PROPOSED REVISION	REVISION JUSTIFICATION
S-10	35, GRID 2	TROTTER POINT, LLC	5770 & 5790 TROTTER ROAD; PARCEL 8, LOT 15	ENTERED METRO DISTRICT	METRO DISTRICT DECISION NO. 02-2012
S-11	42, GRID 7	KINGS COVE HOA, INC.	8509 GUILFORD ROAD; PARCEL 61, P/O LOT 4	ENTERED METRO DISTRICT	METRO DISTRICT DECISION NO. 03-2012
S-12	35, GRID 2	TROTTER CROSSING LLC	5674, 5680 & 5686 TROTTER ROAD; 11712 & 11716 TROTTER CROSSING LANE; PARCEL 481	ENTERED METRO DISTRICT	METRO DISTRICT DECISION NO. 04-2012
S-13	31, GRID 16	TURLEY PROPERTY; TURLEY'S OVERLOOK	SOUTH ILCHESTER ROAD AT TALBOTS LANDING; PARCEL 739, LOT 02	ENTERED METRO DISTRICT	METRO DISTRICT DECISION NO. 05-2012
S-14	41, GRID 6	LEE PROPERTY	10718 HUNTING LANE; PARCEL 252, LOT 69	ENTERED METRO DISTRICT	METRO DISTRICT DECISION NO. 06-2012
S-15	29, GRID 20	SAMUEL & AMBILY PROPERTY	5517 TROTTER ROAD; PARCEL 88, LOT 4	ENTERED METRO DISTRICT	METRO DISTRICT DECISION NO. 01-2013
S-16	41, GRID 6	FEDAK & PETRY PROPERTY	10710 HUNTING LANE; PARCEL 174, LOT 15	ENTERED METRO DISTRICT	METRO DISTRICT DECISION NO. 02-2013
S-17	41, GRID 11	SCHARNHORST PROPERTY	10734 JUDY LANE; PARCEL 420, LOT 3	ENTERED METRO DISTRICT	METRO DISTRICT DECISION NO. 03-2013
S-18	35, GRID 17	HAGOOD PROPERTY	10829 BRAEBURN ROAD; PARCEL 228, LOT 34	ENTERED METRO DISTRICT	METRO DISTRICT DECISION NO. 04-2013
S-19	35, GRID 24	PANDEY & KAPADIA PROPERTY	8030 HARRIET TUBMAN LANE; PARCEL 129	ENTERED METRO DISTRICT	METRO DISTRICT DECISION NO. 05-2013
S-20	35, GRID 17	CORNERSTONE HOLDINGS LLC	10879, 10883 & 10887 HARMEL DRIVE; PARCEL 101, LOTS 1-3	ENTERED METRO DISTRICT	METRO DISTRICT DECISION NO. 06-2013
S-21	35, GRID 8	EMERY & GAJEWSKI PROPERTY	6301 TROTTER ROAD; PARCEL 66	ENTERED METRO DISTRICT	METRO DISTRICT DECISION NO. 07-2013

EXHIBIT 2- SEWER FACILITIES PLAN MAP UPDATES

Revisions to Sewer Service Categories for Subdivision Activity from 2011 through December 2014.

MAP ID	TAX MAP	SUBDIVISION OR OWNER NAME	SECTION/AREA/ BLOCK/ PARCEL/LOTS	PROPOSED REVISION	REVISION JUSTIFICATION
S-22	41, GRID 12	JACOBS PROPERTY	10709 JUDY LANE; PARCEL 253, LOT 18	ENTERED METRO DISTRICT	METRO DISTRICT DECISION NO. 08-2013
S-23	35, GRID 8	RISTWAY PROPERTY	5946 TROTTER ROAD; PARCEL 373, LOT 6	ENTERED METRO DISTRICT	METRO DISTRICT DECISION NO. 09-2013
S-24	31, GRID 10	CASCADE WALTHUR LLC	4806, 4810, 4814 & 4822 WELLSTONE WAY; PARCEL 133, LOTS 4-11-	ENTERED METRO DISTRICT	METRO DISTRICT DECISION NO. 10-2013
S-25	31, GRID 10	WILLIAMSBURG GROUP LLC	4811, 4818 & 4819 WELLSTONE WAY; PARCEL 133, LOTS 1-3	ENTERED METRO DISTRICT	METRO DISTRICT DECISION NO. 11-2013
S-26	31, GRID 10	CASCADE OVERLOOK 4 HOA	WELLSTONE WAY OPEN SPACE LOT 08	ENTERED METRO DISTRICT	METRO DISTRICT DECISION NO. 12-2013
S-27	31, GRID 24	GEELHAAR PROPERTY	5295 LANDING ROAD; PARCEL 619, LOT 3	ENTERED METRO DISTRICT	METRO DISTRICT DECISION NO. 01-2014
S-28	47, GRID 3	BEAZER HOMES CORP	10010 GORMAN ROAD; PARCEL 472	ENTERED METRO DISTRICT	METRO DISTRICT DECISION NO. 02-2014
S-29	10, GRID 13	DORSEY FAMILY HOMES, INC.	1670 HENRYTON ROAD; PARCEL 184	ENTERED METRO DISTRICT	METRO DISTRICT DECISION NO. 03-2014
S-30	35, GRID 8	SARY PROPERTY	5960 TROTTER ROAD; PARCEL 163	ENTERED METRO DISTRICT	METRO DISTRICT DECISION NO. 04-2014
S-31	34, GRID 18	ISICOFF PROPERTY	6215 GUILFORD ROAD; PARCEL 163	ENTERED METRO DISTRICT	METRO DISTRICT DECISION NO. 05-2014
S-32	41, GRID 5	SD PROPERTIES LLC	10821 HUNTING LANE; PARCEL 273, LOT 54	ENTERED METRO DISTRICT	METRO DISTRICT DECISION NO. 06-2014
S-33	34, GRID 12	HO PROPERTY	6118 TULANE DRIVE; PARCEL 123	ENTERED METRO DISTRICT	METRO DISTRICT DECISION NO. 07-2014
S-34	37, GRID 5	ROCK BURN LLC	MONTERY ROAD; PARCEL 52, P/O PARCEL A	ENTERED METRO DISTRICT	METRO DISTRICT DECISION NO. 08-2014

EXHIBIT 2- SEWER FACILITIES PLAN MAP UPDATES

Revisions to Sewer Service Categories for Subdivision Activity from 2011 through December 2014.

MAP ID	TAX MAP	SUBDIVISION OR OWNER NAME	SECTION/AREA/ BLOCK/ PARCEL/LOTS	PROPOSED REVISION	REVISION JUSTIFICATION
S-35	35, GRID 23	PASS PROPERTY	7831 HARRIET TUBMAN LANE; PARCEL 117	ENTERED METRO DISTRICT	METRO DISTRICT DECISION NO. 09- 2014
S-36	37, GRID 20	SADEGHI-BAJGIRAN PROPERTY	NORTH LARK BROWN ROAD; PARCEL 508	ENTERED METRO DISTRICT	METRO DISTRICT DECISION NO. 10- 2014
S-37	16, GRID 14	ARAGHI & ANSARI PROPERTY	2840 KINGS GIFT DRIVE; PARCEL 367, LOT 50	ENTERED METRO DISTRICT	METRO DISTRICT DECISION NO. 11- 2014
S-38	35, GRID 23	ARMSTRONG & RINALDI PROPERTY	7938 HARRIET TUBMAN LANE; PARCEL 321	ENTERED METRO DISTRICT	METRO DISTRICT DECISION NO. 12- 2014
S-39	23, GRID 10	CARROLL PROPERTY	FREDERICK ROAD; PARCEL 149, LOT 1	ENTERED METRO DISTRICT	METRO DISTRICT DECISION NO. 13- 2014
S-40	23, GRID 10	CARROLL PROPERTY	10575 FREDERICK ROAD; PARCEL 149, LOT PARCEL A	ENTERED METRO DISTRICT	METRO DISTRICT DECISION NO. 14- 2014
S-41	17, GRID 11	ESTATES AT PATAPSCO PARK	PARCEL 751, LOT PAR 3; 43.78 ACRES	CHANGE COMPREHENSIVE TO 0- TO-5 YEARS	F-14-124 PLAN SUBMITTED
S-42	18, GRID 01	PHELPS PROPERTY	PARCEL 357, LOT 2; 3.41 ACRES	CHANGE 0-TO-5 YEARS TO EXISTING	F-14-042 FINAL PLAN RECORDED
S-43	17, GRID 16	MT. HEBRON OVERLOOK; LOTS 1-25	PARCEL 416	CHANGE 6-TO-10 YEARS TO EXISTING	F-11-064 FINAL PLAN SUBMITTED
S-44	25, GRID 01	ALTA AT REGENCY CREST	PARCEL 01, LOT PARCEL A; 5.8 ACRES	CHANGE 0-TO-5 YEARS TO EXISTING	F-08-165 FINAL PLAN RECORDED
S-45	24, GRID 6	ELLCOTT MILLS OVERLOOK AND ELLCOTT CROSSING PARTS 1 & 2	PARCEL 852, LOTS E, K	CHANGE 0-TO-5 YEARS TO EXISTING	F-12-014, F-13-043 FINAL PLANS RECORDED
S-46	24, GRID 01	TOWNS AT PATUXENT ORCHARD	PARCEL 647, LOT 2; 5.08 ACRES	CHANGE 0-TO-5 YEARS TO EXISTING	F-13-078 FINAL PLAN RECORDED
S-47	23, GRID 06	KAUFUSS AND CALABRESE LANDS, RITE AID SITE	PARCEL 10, LOT PAR A	CHANGE 0-TO-5 YEARS TO EXISTING	F-09-084 FINAL PLAN RECORDED

EXHIBIT 2- SEWER FACILITIES PLAN MAP UPDATES

Revisions to Sewer Service Categories for Subdivision Activity from 2011 through December 2014.

MAP ID	TAX MAP	SUBDIVISION OR OWNER NAME	SECTION/AREA/ BLOCK/ PARCEL/LOTS	PROPOSED REVISION	REVISION JUSTIFICATION
S-48	23, GRID 10	WESTMOUNT SUBDIVISION	PARCEL 149, LOT 1 & LOT PAR A	CHANGE NO PLANNED SERVICE TO 6-TO-10 YEARS	SP-14-008 PLAN SUBMITTED
S-49	24, GRID 09	LUTHERAN VILLAGE AT MILLER'S GRANT	PARCEL 1001; 49.68 ACRES	CHANGE 0-TO-5 YEARS TO EXISTING	F-10-083 FINAL PLAN RECORDED
S-50	25, GRID 14	AUTUMN OVERLOOK	PARCEL 0095	CHANGE 0-TO-5 YEARS TO EXISTING	F-13-081 FINAL PLAN RECORDED
S-51	25, GRID 14	AUTUMN RIVER PHASE 3	PARCEL 279, LOT 108 PARCEL 0172; LOTS 69-108	CHANGE 0-TO-5 YEARS TO EXISTING	F-10-067 FINAL PLAN RECORDED
S-52	31, GRID 04	LOCUST CHAPEL & LOCUST CHAPEL SEC 01	PARCEL 115, LOTS 1- 69	CHANGE 0-TO-5 YEARS TO EXISTING	F-12-009 FINAL PLAN RECORDED
S-53	30, GRID 02	CENTENNIAL LAKE OVERLOOK SEC 01 & 02	PARCEL 086, PAR A & B	CHANGE 0-TO-5 YEARS TO EXISTING	F-14-002 FINAL PLAN RECORDED
S-54	31, GRID 10	CASCADE OVERLOOK SEC 04	PARCEL 133, LOTS 1- 10	CHANGE 0-TO-5 YEARS TO EXISTING	F-12-074 AND F-12- 075 FINAL PLANS RECORDED
S-55	31, GRID 16	TURLEY'S MEADOW AND TURLEY'S OVERLOOK	PARCEL 738, LOTS 1-4	CHANGE 0-TO-5 YEARS TO EXISTING	F-13-084 AND F-14- 079 FINAL PLANS RECORDED
S-56	41, GRID 21	ENCLAVE AT PARK FOREST	PARCEL 516, UNITS 1- 45	CHANGE 0-TO-5 YEARS TO EXISTING	F-14-129 FINAL PLAN RECORDED
S-57	38, GRID 03	CYPRESS SPRINGS	PARCEL 46, LOTS 1-17	CHANGE 0-TO-5 YEARS TO EXISTING	F-10-028 FINAL PLAN RECORDED
S-58	37, GRID 10	THE WELLNESS CENTER OF HOWARD COUNTY	PARCEL 687, LOT E-1	CHANGE 0-TO-5 YEARS TO EXISTING	F-14-107 FINAL PLAN RECORDED
S-59	47, GRID 02	SCARBOROUGH ESTATES	PARCEL 25, LOTS 1-4	CHANGE 0-TO-5 YEARS TO EXISTING	F-14-091 FINAL PLAN RECORDED
S-60	37, GRID 03	FOX HUNT ESTATES	PARCEL 606, LOTS 36	CHANGE 0-TO-5 YEARS TO EXISTING	F-13-016 FINAL PLAN RECORDED
S-61	35, GRID 02	TROTTER POINT	PARCELS 8, 9, 165; LOTS 15	CHANGE 0-TO-5 YEARS TO EXISTING	F-13-004 FINAL PLAN RECORDED
S-62	34, GRID 18	ENCLAVE AT TIERNEY FARM	PARCEL 88; 89.95 ACRES	CHANGE NO PLANNED SERVICE TO 6-TO-10 YEARS	ECP-15-005 PLAN SUBMITTED

EXHIBIT 2- SEWER FACILITIES PLAN MAP UPDATES

Revisions to Sewer Service Categories for Subdivision Activity from 2011 through December 2014.

MAP ID	TAX MAP	SUBDIVISION OR OWNER NAME	SECTION/AREA/BLOCK/ PARCEL/LOTS	PROPOSED REVISION	REVISION JUSTIFICATION
S-63	41, GRID 22 & 46, GRID 03	MAPLE LAWN FARMS	PARCEL 124; LOTS C-28, C-29 & OS LOT 03	CHANGE 0-TO-5 YEARS TO EXISTING	F-12-086 FINAL PLAN RECORDED
S-64	46, GRID 03	MAPLE LAWN FARMS	PARCEL 124; NON-B PAR C-27 WEST DIST PAR P	CHANGE 0-TO-5 YEARS TO EXISTING	F-12-015 FINAL PLAN RECORDED
S-65	46, GRID 03	ST. FRANCIS OF ASSISSI SUBDIVISION	PARCEL 337, LOT 01	CHANGE 0-TO-5 YEARS TO EXISTING	F-12-061 FINAL PLAN RECORDED
S-66	46, GRID 11	RESERVOIR ESTATES (HIGDON PROPERTY)	PARCEL 56, LOTS 1-26	CHANGE 0-TO-5 YEARS TO EXISTING	F-14-003 FINAL PLAN RECORDED
S-67	42, GRID 21 47, GRID 2	WINCOPIA FARMS	PARCEL 472127.6 ACRES	CHANGE 6-TO-10 YEARS TO EXISTING	F-13-003 FINAL PLAN RECORDED
S-68	47, GRIDS 2-8	WALDEN WOODS	PARCEL 4, LOTS 98	CHANGE 0-TO-5 YEARS TO EXISTING	F-13-032 FINAL PLAN RECORDED
S-69	47, GRID 06	NORDAU SUBDIVISION	PARCEL 668, SEC E-1, LOTS 13-18	CHANGE 0-TO-5 YEARS TO EXISTING	F-12-047 FINAL PLAN RECORDED
S-70	43, GRID 19	CHASE LAND SUBDIVISION	PARCEL 235, LOT 2; 23.2 ACRES	CHANGE 0-TO-5 YEARS TO EXISTING	F-09-071 FINAL PLAN RECORDED
S-71	37, GRID 16-22	THE MEADOWS CORPORATE PARK	PARCEL 173, LOT A-6; 33.16 ACRES	CHANGE 0-TO-5 YEARS TO EXISTING	F-14-035 FINAL PLAN RECORDED
S-72	38, GRID 09	SHADY LANE CROSSING	PARCEL 235, LOTS 1-25	CHANGE 0-TO-5 YEARS TO EXISTING	F-06-097 FINAL PLAN RECORDED
S-73	38, GRIDS 14-15	WINTER CREST	PARCEL 868, LOTS 1-8	CHANGE 0-TO-5 YEARS TO EXISTING	F-12-076 FINAL PLAN RECORDED
S-74	48, GRID 02	DORSEY WOOD	PARCEL 134, LOT PAR B	CHANGE 0-TO-5 YEARS TO EXISTING	F-13-086 FINAL PLAN RECORDED
S-75	47, GRID 08	EMERSON	PARCEL 1051, SEC 03, AREA 01, LOT PAR B	CHANGE 0-TO-5 YEARS TO EXISTING	F-13-073 FINAL PLAN RECORDED
S-76	47, GRID 20	REVITZ PROPERTY	PARCEL 165, LOT PAR D-1	CHANGE 0-TO-5 YEARS TO EXISTING	F-11-052 AND F-11-094 FINAL PLANS RECORDED

EXHIBIT 2- SEWER FACILITIES PLAN MAP UPDATES

Revisions to Sewer Service Categories for Subdivision Activity from 2011 through December 2014.

MAP ID	TAX MAP	SUBDIVISION OR OWNER NAME	SECTION/AREA/BLOCK/PARCEL/LOTS	PROPOSED REVISION	REVISION JUSTIFICATION
S-77	47, GRIDS 19-20; 50, GRIDS 1-2	HIGH RIDGE MEADOWS SEC 01 (DEER SPRINGS SEC 01)	PARCELS 363 & 542; LOT B; 36.94 ACRES	CHANGE 0-TO-5 YEARS TO EXISTING	F-14-022 FINAL PLAN RECORDED
S-78	17, GRID 19	CARLEE RUN COURT AREA	PARCEL 123, LOTS 1-26	CHANGE 0-TO-5 YEARS TO EXISTING	COMPLETED CONSTRUCTION OF SEWER CONTRACT 20-4643
S-79	32, GRID 20	ROCKBURN LANDING AREA	ROCKBURN HILL ROAD & CROSSVIEW ROAD	CHANGE 0-TO-5 YEARS TO EXISTING	COMPLETED CONSTRUCTION OF SEWER CONTRACT 14-4715
S-80	32, GRID 20	ELIBANK DRIVE AREA	6400-6450 ELIBANK DRIVE	CHANGE FROM COMPREHENSIVE TO 6-TO-10 YEARS	COMPLETED CONSTRUCTION OF SEWER CONTRACT 14-4715
S-81	29, GRID 12	CLARKSVILLE PIKE AREA	10400-10600 CLARKSVILLE PIKE	CHANGE 0-TO-5 YEARS TO EXISTING	COMPLETED CONSTRUCTION OF SEWER CONTRACT 24-4690

EXHIBIT 2 - East HOWARD COUNTY MASTER PLAN FOR WATER AND SEWER SEWER

NOVEMBER 2015

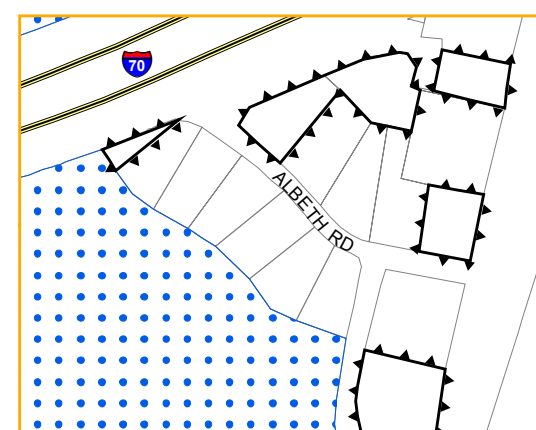

Albeth Heights

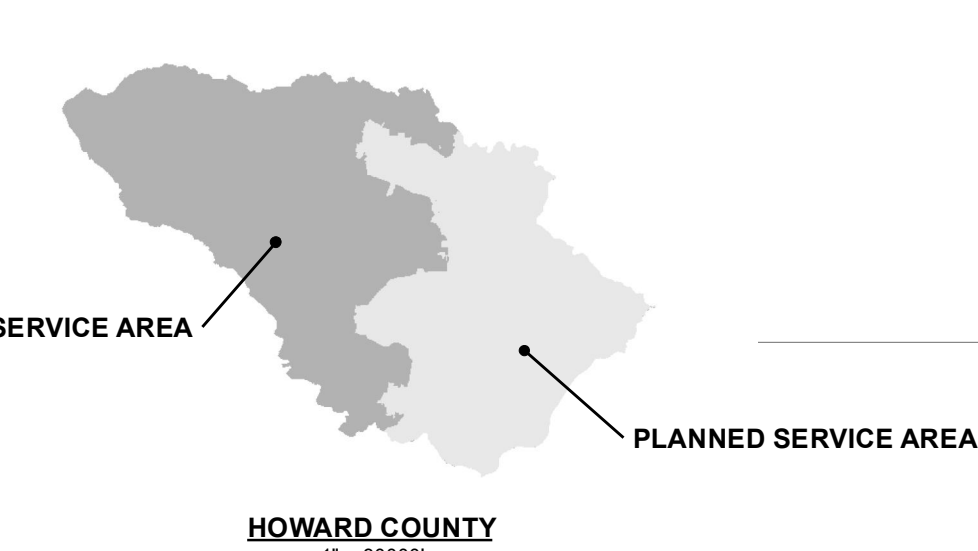

HOWARD COUNTY
1" = 30,000'

SERVICE AREAS*

- 0 to 5 Years
 - 6 to 10 Years
 - Comprehensive
 - Alpha Ridge & Marriottsville Area (No Planned Sewer Service)
 - No Planned Service
 - Park/Open Space
 - Service Area Revision since 2011
 - Drainage Areas
- *Areas not in any of the above categories are Existing/Under Construction

FACILITIES

- | | EXISTING | PLANNED |
|----------------------------|-------------------|--------------------|
| Pump Station | | |
| Treatment Plant | | |
| Sewer Line | | |
| Force Main | | |
| Shared Sewer Disposal Area | | |
| Metropolitan District | (Inside District) | (Outside District) |
| Interceptor Node | | |

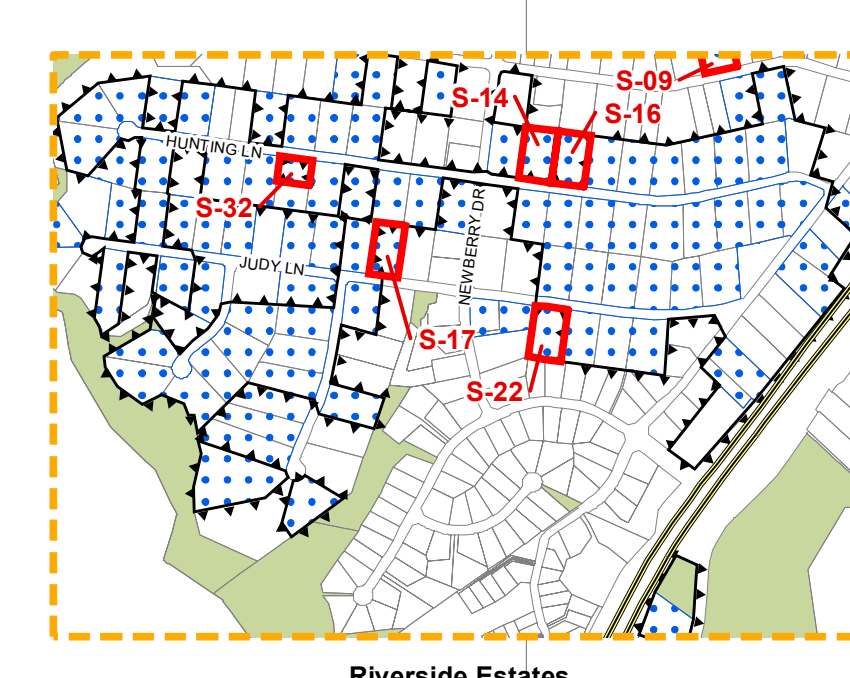
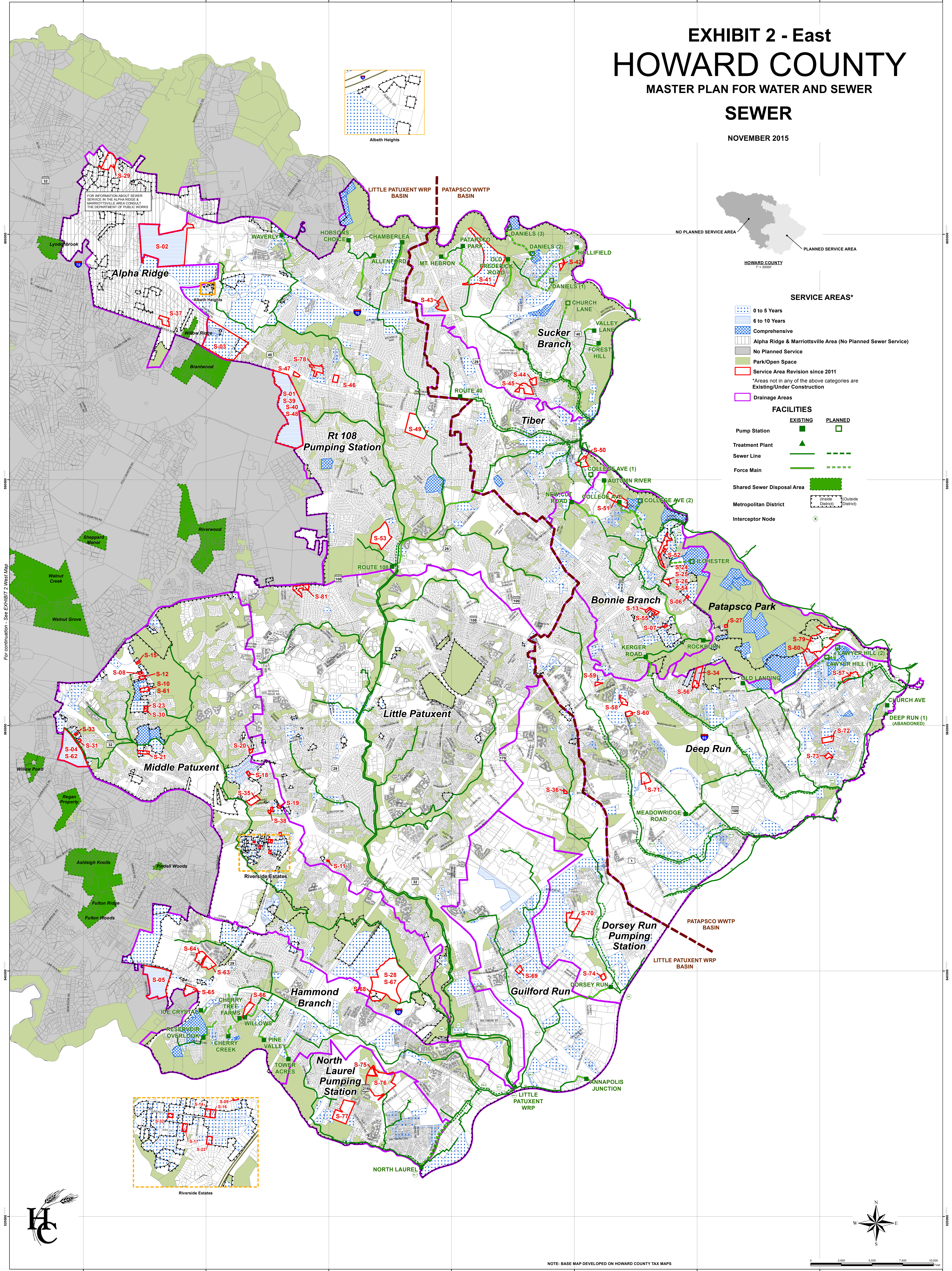

Riverside Estates

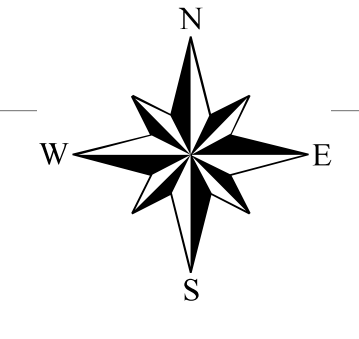

NOTE: BASE MAP DEVELOPED ON HOWARD COUNTY TAX MAPS

EXHIBIT 2 - West HOWARD COUNTY



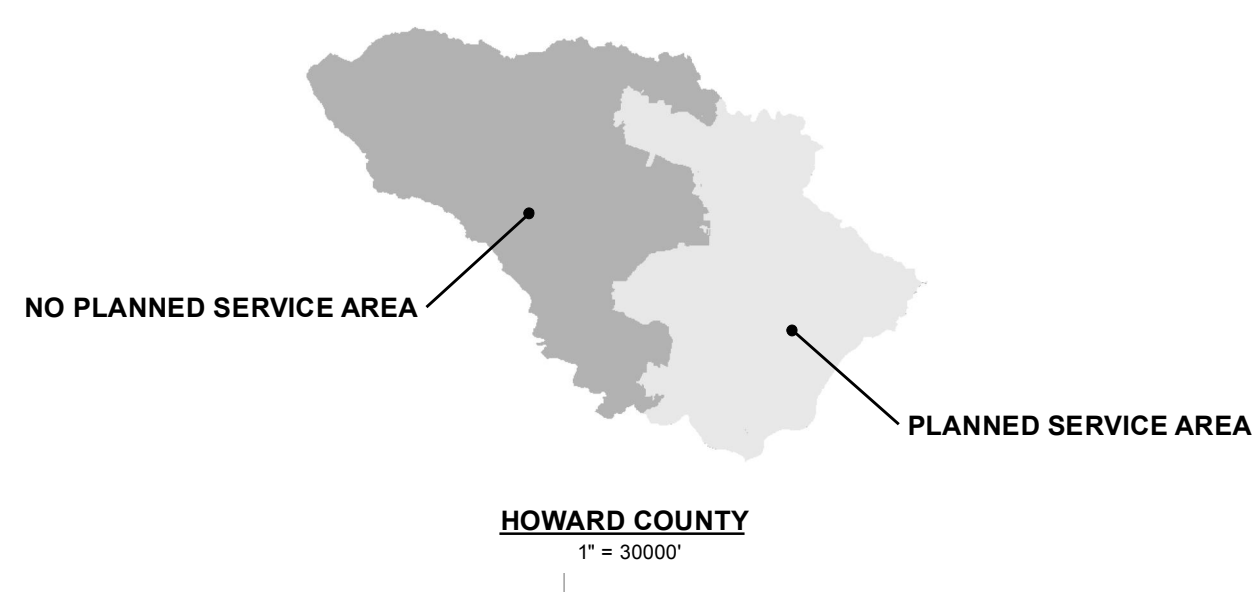
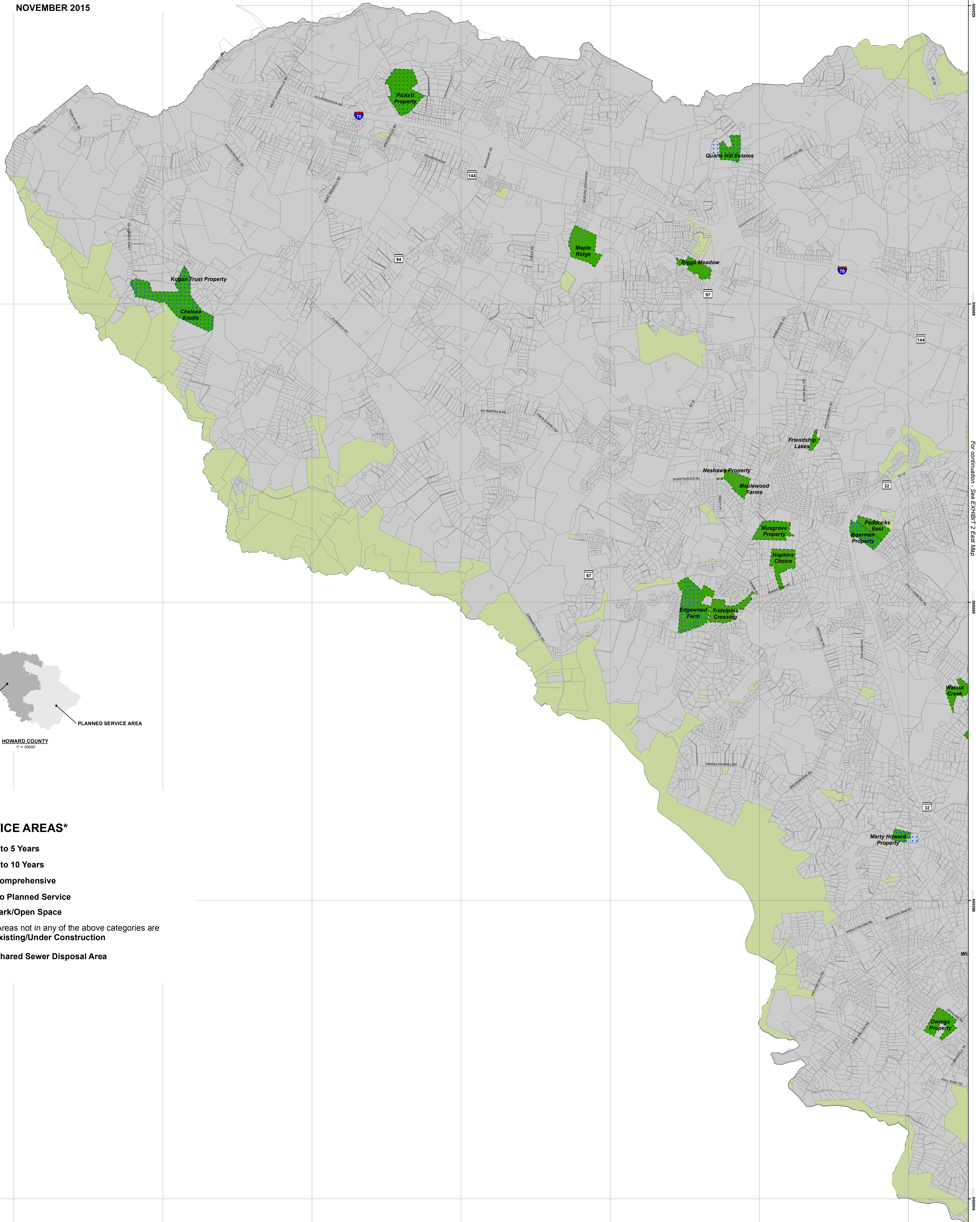

MASTER PLAN FOR WATER AND SEWER

SEWER

NOVEMBER 2015

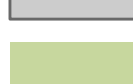

SERVICE AREAS*

-  0 to 5 Years
-  6 to 10 Years
-  Comprehensive
-  No Planned Service
-  Park/Open Space

*Areas not in any of the above categories are Existing/Under Construction

-  Shared Sewer Disposal Area

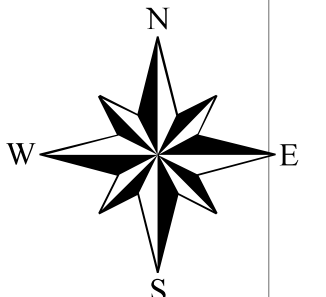

NOTE: BASE MAP DEVELOPED ON HOWARD COUNTY TAX MAPS

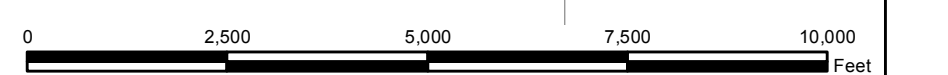

For continuation - See EXHIBIT 2 - East Map

EXHIBIT 3

**1986 Baltimore City &
Howard County Water Agreement**

AGREEMENT

JUL 9 1986

THIS AGREEMENT, made this ____ day of _____, 1986, by and between the Mayor and City Council of Baltimore, a municipal corporation of the State of Maryland, hereinafter referred to as BALTIMORE CITY; and Baltimore County, Maryland, a body corporate and politic of the State of Maryland, hereinafter referred to as BALTIMORE COUNTY; and Howard County, Maryland, a body corporate and politic of the State of Maryland, hereinafter referred to as HOWARD COUNTY.

WHEREAS, the General Assembly of the State of Maryland has established through Legislative Acts that BALTIMORE CITY has a statutory obligation to supply water to the Metropolitan District of BALTIMORE COUNTY; and

WHEREAS, BALTIMORE CITY, BALTIMORE COUNTY and HOWARD COUNTY entered into an agreement dated November 6, 1957, hereinafter referred to as the "1957 Agreement", for the purpose of extending water supply mains and constructing appurtenant works for furnishing water from the Western Third Zone of BALTIMORE CITY'S water distribution system through BALTIMORE COUNTY to HOWARD COUNTY; and

WHEREAS, under the terms of the 1957 Agreement, BALTIMORE CITY, BALTIMORE COUNTY and HOWARD COUNTY constructed sections of a water transmission main from the intersection of Wetheredsville Road and Windsor Mill Road in BALTIMORE CITY, to the boundary separating BALTIMORE COUNTY and HOWARD COUNTY at the Baltimore National Pike (U. S. Route 40); and

WHEREAS, under the terms of the 1957 Agreement, BALTIMORE CITY installed larger pumps at the Ashburton Pumping Station, in part for the purpose of supplying HOWARD COUNTY with water at a maximum daily rate of 8.5 million gallons per day, and at an average daily rate of 5.0 million gallons per day; and

WHEREAS, under the terms of the 1957 Agreement, BALTIMORE COUNTY acquired a site near the intersection of U. S. Route 40 and Rolling Road upon which to construct the Rolling Road Reservoir, now known as the Catonsville Reservoir; and

WHEREAS, the Catonsville Reservoir, which was to have been constructed by BALTIMORE COUNTY under the terms of the 1957 Agreement, has not yet been constructed; and

WHEREAS, there have been, and will continue to be, substantial changes in the size and location of the population served from the Western Third Zone water distribution system; and

WHEREAS, the increased water demands associated with the projected changes in population cannot be supplied by the existing system of water supply mains and appurtenant works within the Western Third Zone; and

WHEREAS, it is the desire of all parties to this agreement that certain water supply mains and appurtenant works within the Western Third Zone be constructed to accommodate the future water demands of the parties hereto; and

WHEREAS, it is the intent of all parties to this agreement that capacity shares and a method for the computation and payment of capital costs be established for water supply mains and appurtenant works to be constructed under this agreement; and

WHEREAS, analyses have been completed, are underway, or will be conducted in the future to determine the sizing, construction scheduling, and capacity shares of future water supply mains and appurtenant works through year 2025.

NOW, THEREFORE, THIS AGREEMENT WITNESSETH; that in consideration of the covenants, agreements, and payments set forth herein, it is mutually covenanted and agreed as follows:

ARTICLE I - DEFINITIONS

- A. "Party or Parties" shall mean BALTIMORE CITY, BALTIMORE COUNTY and/or HOWARD COUNTY, as appropriate, each of these jurisdictions being a signatory to this agreement.
- B. "Jointly-Used Facility" is any installation, including real and personal property, specifically identified in this agreement which distributes, transmits, pumps, and/or treats potable water in the Western Third Zone for more than one party to this agreement.
- C. "Capital Cost" is the net cost involved in the construction, installation or rehabilitation of a water supply facility and shall include, but not be limited to, the sum of the following items: Land and/or easements; consultants' fees including those for design and inspection; material; labor; utility relocations; overhead which may include a proportionate allocation of in-house costs associated with design, field engineering, surveys, borings, materials testing, maps and records maintenance, inspection, right-of-way expenses, advertising, administrative services, clerical services, stenographic services, office space use and building operation and maintenance; and all other contributing costs or expenses. Capital cost does not include operation and maintenance costs incurred after the completion and final acceptance of the facility.
- D. "Design Flow Method" is a method of cost allocation for a jointly used facility which is based upon the allocation of the total design capacity of said facility among the parties. The ratio of cost responsibility for a party is determined by dividing the portion of the total design capacity of the jointly used facility allocated to the party by the total design capacity of the facility.
- E. "Director" shall mean the Director of Public Works of any party to this agreement, or his duly authorized representatives or agents.
- F. "Purchased Design Capacity" is that portion of the total design capacity of a jointly used facility that the capital cost payment of any one party bears to the total capital cost for construction or installation of said facility.

ARTICLE II - FINANCING OF JOINTLY USED FACILITIES

- A. All parties shall share the capital cost associated with constructing, installing or rehabilitating jointly used facilities as specified in Article III, Paragraphs (B) and (C).
- B. The total capital cost for any jointly used facility specified in Article III, Paragraphs (B) and (C), shall be apportioned to each party by the Design Flow Method at the time of construction, installation or rehabilitation.
- C. The party responsible for construction, installation or rehabilitation of a jointly used facility shall, as construction progresses, issue periodic billings based upon work completed to the other parties sharing in the capital cost of the jointly used facility. Such billings shall be payable not later than thirty (30) days after issuance.
- D. The party responsible for construction, installation or rehabilitation of a jointly used facility shall, upon completion of said facility, prepare a final audit of all related capital costs. The other parties shall, upon receipt of the final audit and a final billing, pay any balance due for their respective shares of the capital cost as determined by the Design Flow Method. In the event that the respective sums previously billed and paid are in excess of the parties' respective capital cost shares as determined by the Design Flow Method, the party responsible for construction, installation or rehabilitation of the jointly used facility shall return to each affected party the difference between the sum paid by that party and the capital cost share owed by that party, in accordance with the final audit.
- E. Each party shall have the right to audit another party's statements and accounts related to the performance of this agreement. Such audits shall be made at the auditing party's expense.

ARTICLE III - JOINTLY USED FACILITIES

- A. All parties shall participate in the construction, installation or rehabilitation of the jointly used facilities specified and described in Paragraphs (B) and (C) of this Article, and as generally identified

on the Map included as Attachment No. 1 to this agreement. It is the intent of this agreement that each jointly used facility described in Paragraphs (B) and (C) of this article shall be constructed, installed or rehabilitated as set forth hereinafter. Cost share ratios, expressed as percentages by jurisdiction for each jointly used facility, are based on the Design Flow Method of cost allocation. The derivation of cost share ratios for each jointly used facility are given in Attachment No. 3 to this agreement.

B. The jointly used facilities to be constructed or installed under the terms of this agreement are as follows:

1. Catonsville Transmission Main, Section 2

BALTIMORE COUNTY shall design and construct Section 2 of the Catonsville Transmission Main, as soon as practicable with a target date of 1986, which main shall be 48" in diameter and shall extend along Forest Park Avenue from Cooks Lane to the intersection of Harlem Lane and U. S. Route 40, a distance of approximately 5,300 linear feet. The parties agree to share in the cost of this main at the following percentages: 9.25% to be paid by BALTIMORE COUNTY; and 90.75% to be paid by HOWARD COUNTY.

2. Catonsville Transmission Main, Section 4

HOWARD COUNTY shall design and construct Section 4 of the Catonsville Transmission Main, as soon as practicable with a target date of 1988, which main shall be 48" in diameter and shall extend along U. S. Route 40 from the existing 36" diameter Catonsville Pumping Station suction main to the border separating HOWARD and BALTIMORE COUNTIES, a distance of approximately 6,100 linear feet. HOWARD COUNTY shall also design and construct a meter along the transmission main at a location near the border separating HOWARD and BALTIMORE COUNTIES as specified in Article VI (A). The parties agree to share in the cost of this main and meter at the following percentages: 100% to be paid by HOWARD COUNTY.

3. Catonsville Reservoir, East Bay

BALTIMORE COUNTY shall design and construct the East Bay of the Catonsville Reservoir, as soon as practicable with a target date of 1988, which bay shall have a storage capacity of approximately 30 million gallons and an overflow elevation of 567.4 feet. The East

Bay shall be located at the site owned by BALTIMORE COUNTY upon which the Catonsville Pumping Station is presently located. The actual storage capacity shall be determined from an engineering study prepared by BALTIMORE COUNTY. The East Bay shall provide for the necessary storage requirements requested by each party, and specified in Attachment No. 2. The East Bay shall be designed and constructed to allow for the future construction of additional storage facilities to provide for the year 2025 storage requirements requested by each party, and specified in Attachment No. 2. The parties agree to share in the cost of the East Bay at percentages derived using the design flow method of cost allocation as applied using the storage requirements of each party. The general method of cost allocation to be used is detailed in Attachment No. 3, Section (C).

4. Leakin Park Pumping Station

BALTIMORE CITY shall design and construct the Leakin Park Pumping Station, as soon as practicable with a target date of 1988, which station shall be located in Leakin Park at a site determined from an engineering design study prepared by BALTIMORE CITY. Construction of the pumping station shall include the installation of the pumps recommended for initial installation in the engineering design study. These pumps shall provide, in conjunction with the Ashburton Pumping Station, for the necessary maximum day demands requested by each party, and specified in Attachment No. 2. The pumping station shall be designed and constructed to allow for the future installation of additional pumps as specified in the engineering design study. These additional pumps shall provide, in conjunction with the Ashburton Pumping Station, for the year 2025 maximum day demands requested by each party, and specified in Attachment No. 2. HOWARD COUNTY agrees to advance funds to BALTIMORE CITY for the design of the pumping station. The parties agree to share in the cost of the Leakin Park Pumping Station at percentages derived using the design flow method of cost allocation as applied using the maximum day demands of each party. The general method of cost allocation

to be used is detailed in Attachment No. 3, Section (D). BALTIMORE COUNTY agrees to reimburse HOWARD COUNTY for a percentage of the design cost of the pumping station, said percentage being that derived as BALTIMORE COUNTY'S share in the cost of the Leakin Park Pumping Station.

5. Catonsville Transmission Main, Section 1-S

BALTIMORE CITY shall design and construct Section 1-S of the Catonsville Transmission Main as soon as practicable with a target date of 1988, which main shall be 60" in diameter and shall consist of the suction and discharge mains for the Leakin Park Pumping Station. The suction main shall be located between the existing 66" diameter stub along the Gwynns Falls Transmission Main and the Leakin Park Pumping Station. The discharge main shall be located between the Leakin Park Pumping Station and the existing 48" diameter Leakin Park transmission main. HOWARD COUNTY agrees to advance funds to BALTIMORE CITY for the design of the transmission main. The parties agree to share in the cost of Section 1-S of the Catonsville Transmission Main at the same percentages derived for sharing in the cost of constructing the Leakin Park Pumping Station. BALTIMORE COUNTY agrees to reimburse HOWARD COUNTY for a percentage of the design cost of the transmission main, said percentage being that derived as BALTIMORE COUNTY'S share in the cost of the Leakin Park Pumping Station.

C. The jointly used facilities to be rehabilitated under the terms of this agreement are as follows:

1. Melvin Avenue Transmission Main, Cleaning and Lining

BALTIMORE COUNTY shall clean and line a portion of the existing Melvin Avenue Transmission Main as soon as practicable with a target date of 1989, which main is 20" in diameter and extends along Melvin Avenue from the existing Melvin Avenue storage tank to the intersection of Melvin Avenue and Frederick Avenue, a distance of approximately 1,200 linear feet. The parties agree to share in the cost of this rehabilitation at the following percentages: 64.36% to be paid by BALTIMORE COUNTY; and 35.64% to be paid by HOWARD COUNTY.

2. Harlem Lane Transmission Main, Cleaning and Lining

BALTIMORE COUNTY shall clean and line a portion of the existing Harlem Lane Transmission Main as soon as practicable with a target date of 1989, which main is 16" in diameter and extends along Harlem lane, Edmondson Avenue, and Melvin Avenue from U. S. Route 40 to the existing Melvin Avenue storage tank, a distance of approximately 8,975 linear feet. The parties agree to share in the cost of this rehabilitation at the following percentages: 64.36% to be paid by Baltimore County; and 35.64% to be paid by HOWARD COUNTY.

3. Rolling Road Transmission Main, Cleaning and Lining

BALTIMORE COUNTY shall clean and line the existing Rolling Road Transmission Main as soon as practicable with a target date of 1990, which main is 16" in diameter and extends along Rolling Road from Newburg Avenue to Wilkens Avenue, a distance of approximately 5,340 linear feet. The parties agree to share in the cost of this rehabilitation at the following percentages: 65.79% to be paid by BALTIMORE COUNTY; and 34.21% to be paid by HOWARD COUNTY.

- D. All parties recognize that the sizing of jointly used facilities and the years and cost shares specified in Paragraphs (B) and (C) of this Article, for construction, installation, and rehabilitation of jointly used facilities have been determined based upon hydraulic modeling and upon the projected demands given in Attachment No. 2 of this agreement. All parties agree that if projected demands or hydraulic modeling results change, this agreement shall be revised by amendment to provide for the sizing, cost sharing, and scheduling of jointly used facilities compatible with the revised projected demands and hydraulic modeling results. This agreement shall also be revised to incorporate the revised projected demands and hydraulic modeling results as appropriate.
- E. All parties recognize that additional jointly used facilities not presently identified in this agreement will be required in the future as specified in the Western Third Zone Study prepared by the Water Analyzer Office and dated August, 1984. All parties agree that this agreement shall be revised when necessary to incorporate

those jointly used facilities which are recommended in the Western Third Zone Study for construction, installation, or rehabilitation within a six (6) year period following issuance or revision of the study.

- F. All parties agree that the Western Third Zone Study shall be jointly reviewed at three (3) year intervals, or at other times if requested in writing by any party, to determine the need for updating projected demands, hydraulic modeling results, implementation schedules, or any other portions of the study affecting the construction, installation, or rehabilitation of jointly used facilities. Appropriate revisions shall be made to the study after review and approval by each party.

ARTICLE IV - DESIGN AND CONSTRUCTION OF JOINTLY USED FACILITIES

- A. All jointly used facilities located in BALTIMORE CITY and BALTIMORE COUNTY, including the flow metering facilities as described in Article III, Paragraph (B)(2), shall be designed, constructed, rehabilitated, installed and tested in accordance with the applicable codes, rules and regulations of BALTIMORE CITY and BALTIMORE COUNTY.
- B. Any party shall, upon request, have the right to review reports, plans, specifications and bids for the rehabilitation, construction and/or installation of any jointly used facility owned or operated by another party. Where a party requests review of any or all of the documents specified above, said documents, including significant revisions, shall not be approved without the consent of the reviewing party. Any costs incurred for said review by BALTIMORE COUNTY or HOWARD COUNTY shall be borne exclusively by the reviewing party. Any costs incurred for said review by BALTIMORE CITY shall be borne by BALTIMORE COUNTY and HOWARD COUNTY, and shall be divided based on the cost share percentages for the applicable jointly used facility as given in Article III, Paragraphs (B) AND (C).
- C. All jointly used facilities shall be constructed, installed, or rehabilitated in accordance with the approved plans and specifications.

ARTICLE V - INSPECTION OF JOINTLY USED FACILITIES AND RECORDS

- A. The premises of any jointly used facility, which is being constructed, rehabilitated, or installed, may be entered and inspected by any party with previous written notice to the party which owns the jointly used facility. Inspection of a jointly used facility shall be accomplished by the Directors of the parties involved.
- B. Each party shall have ready access to all design data, construction plans, specifications, schedules, office and field records, costs records and files for the jointly used facilities of any other party.
- C. Any costs incurred by BALTIMORE COUNTY or HOWARD COUNTY associated with the inspection of any jointly used facility being constructed, rehabilitated, or installed shall be borne by the inspecting party. Any costs incurred by BALTIMORE CITY for the inspection of any jointly used facility being constructed, rehabilitated, or installed shall be borne by BALTIMORE COUNTY and HOWARD COUNTY, and shall be divided based on the cost share percentages for the applicable jointly used facility as given in Article III, Paragraphs (B) and (C).
- D. Each party shall maintain copies of records as specified in this Article, Paragraph (B), for the jointly used facilities constructed, rehabilitated, or installed by that party.

ARTICLE VI - METERING

- A. In order to measure and record automatically the volume and flow rate of water supplied to Howard County from the Catonsville Transmission Main, Section 4, as described in Paragraph (B)(2) of Article III, a recording and registering flow meter, satisfactory to and approved by the Directors of HOWARD COUNTY and BALTIMORE CITY, shall be constructed, installed, and ready for regular continuous service near the border separating BALTIMORE and HOWARD COUNTIES at such time as the transmission main is placed in service. The cost of said meter and its installation shall be borne entirely by HOWARD COUNTY. The meter shall be operated and maintained by BALTIMORE CITY and the cost of said operation and maintenance shall be borne entirely by HOWARD COUNTY.

- B. In the event of failure of the meter installed as specified in Paragraph (A) of this Article, or in the event of failure of the meter previously installed on the existing 24" diameter transmission main along U. S. Route 40, BALTIMORE CITY agrees to proceed with repairs within 60 days or to order replacements within 60 days.

ARTICLE VII - OWNERSHIP AND MAINTENANCE RESPONSIBILITY

- A. Legal title to a jointly used facility constructed or installed under the terms of this agreement shall be and remain with the party in which the jointly used facility is located.
- B. At no time may any party's use of a jointly used facility exceed that party's purchased design capacity of said facility except as specified in Paragraph (C) of this Article without the express written permission of the other parties and the execution of appropriate amendments to this agreement which specify the adjusted purchased design capacities for each party.
- C. Paragraph (B) of this Article does not apply to the Leakin Park Pumping Station and its associated suction and discharge mains. At no time may any party's combined use of the Leakin Park Pumping Station (including its suction and discharge mains) and the Ashburton Pumping Station exceed the flow rates applicable to that party as specified in Attachment No. 2 to this agreement without the expressed written permission of the other parties and the execution of appropriate amendments to this agreement which specify the adjusted allowable flow rates for each party. Paragraph (B) of this Article also does not apply in the event of an emergency during which BALTIMORE CITY is required to provide water service in accordance with Article 25, Section 168 of the Annotated Code of Maryland.
- D. No party may relinquish all or part of that party's purchased design capacity and related cost sharing responsibility in a jointly used facility, nor may any party increase that party's purchased design capacity and related cost sharing responsibility in a jointly used facility, without the expressed written permission of the other parties, and the execution of appropriate amendments to this agreement which specify the adjusted purchased design capacities for each party.

- E. Whenever an amendment to this agreement results in a change to any party's purchased design capacity in a jointly used facility, the cost sharing responsibility for the construction or installation of said facility shall be adjusted accordingly. Immediately after execution of amendments to this agreement which specify the adjusted purchased design capacities, each party owed an adjustment in cost sharing responsibility shall invoice the owing party for said adjustment. The party liable for the adjustment shall remit the owed amount in a lump sum cash payment no later than sixty (60) days after receipt of the invoice for said adjustment.
- F. BALTIMORE CITY shall be responsible for and shall supervise the operation and maintenance of jointly used facilities located within BALTIMORE CITY and BALTIMORE COUNTY in accordance with previous agreements.
- G. All parties recognize that the construction, installation, or rehabilitation of the jointly used facilities specified in Paragraphs (B) and (C) of Article III, shall not, except as noted in Item H of this Article, entitle any party to additional water supply volumes or flow rates from the Ashburton Filtration Plant and the Ashburton Pumping Station above those specified in previously executed agreements. All parties further recognize that a permanent increase in the water supply volumes and flow rates available to each party will be contingent upon the execution of a future agreement addressing facilities within the BALTIMORE CITY central water system.
- H. All parties agree that HOWARD COUNTY shall be allowed to exceed the maximum daily withdraw rate specified in the November 6, 1957 agreement until such time as the jointly used facilities specified in Paragraph (B) of Article III are constructed and a central water system agreement is executed. All parties further recognize that this item will be effective only if unused capacity is available in the Western Third Zone.

ARTICLE VIII - EXCHANGE OF INFORMATION

- A. The Director of each party shall annually prepare a listing of the jointly used facilities specified in Paragraphs (B) and (C) of Article III which are located within that party's borders and which

- the Director intends to include in his party's proposed Five-Year Capital Improvement Program. The listing shall include a description, estimated cost, and schedule for proposed construction, installation, or rehabilitation of each jointly used facility. The listing shall be transmitted to the Directors of the other parties by November 1 of each year.
- B. Giving consideration to the listings transmitted as specified in Paragraph (A) of this Article, the Director of each party shall prepare a proposed Five-Year Capital Improvement Program which provides for the construction, installation, or rehabilitation of jointly used facilities specified in Paragraphs (B) and (C) of Article III by the years indicated. Each Director shall include adequate funding in that party's proposed annual fiscal budget for the jointly used facilities specified in his Capital Improvement Program.
- C. Upon approval of the annual fiscal budget, each Director shall notify the other Directors of those jointly used facilities which have been included in that party's officially adopted annual fiscal budget and Capital Improvement Program. Each such annual notification will be deemed to supercede all prior such notifications.
- D. Before any party commences construction, installation, or rehabilitation of a jointly used facility, the other parties shall certify that funds for their capital cost shares are available. In the event that funds are not available from a party, that party shall attempt to obtain funds as quickly as possible or to make other mutually agreeable arrangements for payments.

ARTICLE IX - RIGHTS AND LIMITATIONS

- A. Nothing in this agreement shall limit or abrogate any right or rights of any party to enter into other separate agreements for the planning, design and construction of water supply facilities providing such separate agreements do not conflict with this agreement or any prior agreements made between the parties.
- B. Nothing contained in this agreement shall limit or abrogate any right or rights delegated to each party by Acts of the General Assembly of the State of Maryland.

- C. Nothing contained in this agreement shall be construed to abridge or restrict the police, legislative or governmental powers of any party to this agreement.
- D. Each party shall recognize all rights and privileges acquired by another party through the acquisition of property and/or rights-of-way.
- E. This agreement, except as specifically noted, applies only to those portions of BALTIMORE CITY, BALTIMORE COUNTY, and HOWARD COUNTY which are served or will be served by the Western Third Zone water distribution system.
- F. The agreement dated November 6, 1957 between BALTIMORE CITY, BALTIMORE COUNTY and HOWARD COUNTY is hereby updated. In the event that any terms or conditions in this agreement are found to conflict with terms or conditions in the November 6, 1957 agreement, this agreement shall supersede the conflicting terms or conditions of the November 6, 1957 agreement.

ARTICLE X - REVISIONS AND DISPUTES

- A. The terms and conditions provided for in this agreement shall continue in full force and effect until the parties amend this agreement or execute a new replacement agreement.
- B. If, in the opinion of any party, it becomes necessary or desirable, to amend this agreement or execute a new agreement, that party shall so notify the other parties in writing. The written notification shall include a draft of the desired amendment or new agreement. If the parties are unable to agree on the proposed amendment or new agreement, the present agreement shall continue in full force and effect until such time as legal remedies available to a party, if pursued, result in an amendment to this agreement or a new agreement.

IN WITNESS WHEREOF, the parties hereto have properly executed this agreement, as of the day, month, and year first above written.

BALTIMORE CITY, MARYLAND
Mayor and City Council of Baltimore

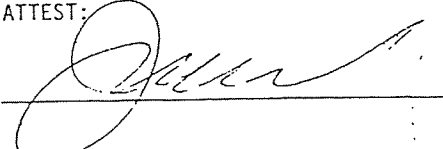
ATTEST:

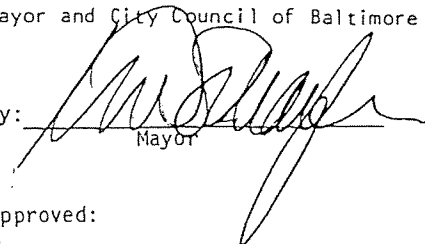
By: 

Mayor

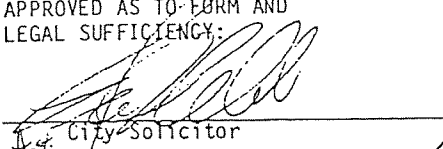
APPROVED AS TO FORM AND
LEGAL SUFFICIENCY:

City Solicitor

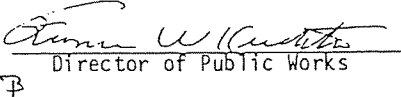
Approved:

Director of Public Works

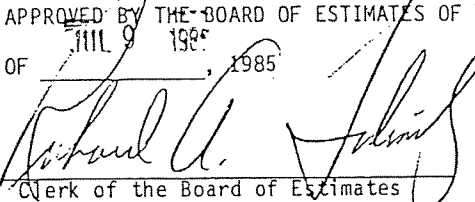
APPROVED BY THE BOARD OF ESTIMATES OF THE CITY OF BALTIMORE THIS _____ DAY
OF 1111 9 1985

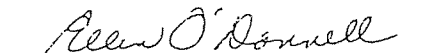

Clerk of the Board of Estimates

BALTIMORE COUNTY, MARYLAND

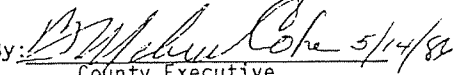
ATTEST:

By: 

County Executive
[FOR DONALD P. HUTCHINSON]

APPROVED AS TO FORM AND
LEGAL SUFFICIENCY:

DEP. County Solicitor

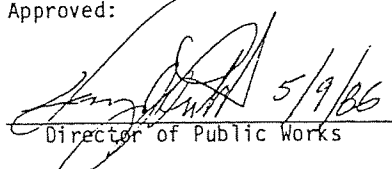
Approved:

Director of Public Works

HOWARD COUNTY, MARYLAND

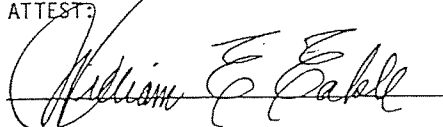
ATTEST:

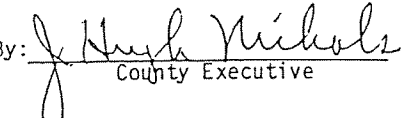
By: 

County Executive

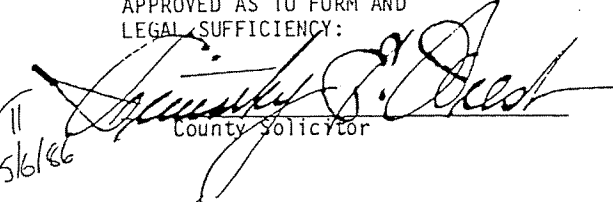
APPROVED AS TO FORM AND
LEGAL SUFFICIENCY:

County Solicitor
5/6/86

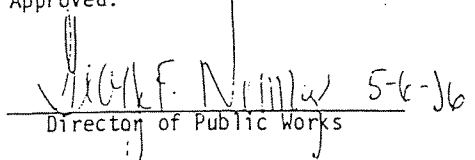
Approved:

Director of Public Works

AGREEMENT ATTACHMENT NO. 2

AVERAGE DAY WATER DEMANDS , MAXIMUM DAY WATER DEMANDS AND STORAGE REQUIREMENTS

A. Assumptions and Conditions

1. The Ashburton Pumping Station and the Leakin Park Pumping Station shall together have adequate capacity to pump the total maximum day water demands for the Western Third Zone.
2. Projected maximum and average day water demands assumed for BALTIMORE CITY and BALTIMORE COUNTY are as given in the Western Third Zone Study prepared by the Water Analyzer Office and dated August, 1984. Flows are given for the years 1980, 2000 and 2025 (the design year). It is assumed that maximum and average day demands will increase linearly between years 1980 and 2000, and between years 2000 and 2025.
3. Projected maximum and average day water demands assumed for HOWARD COUNTY are as given in the Western Third Zone Study for years 1980 and 2025, and as given in the 1985 Howard County Master Plan for Water and Sewerage for years 1990, 1995, 2000, and 2005. It is assumed that average and maximum day demands will increase linearly between years 1980 and 1990; between years 1990 and 1995; between years 1995 and 2000; between years 2000 and 2005, and between years 2005 and 2025.
4. The Ashburton Pumping Station has a current capacity equal to 79 mgd based on the measured flow pumped for the maximum day realized during the summer of 1983. Based upon hydraulic modeling using pump curves for the Leakin Park Pumping Station specified in the engineering design study prepared by BALTIMORE CITY, it is anticipated that the capacity of the Ashburton Pumping Station will decrease below 79 mgd by the design year (2025). It is assumed that the pump station's capacity will decrease linearly from 79 mgd in 1985 to the identified lower capacity in 2025.
5. Storage for the Western Third Zone shall be provided by the Melvin Avenue storage tank, the Pikesville Reservoir, and the Catonsville Reservoir. The Melvin Avenue tank is assumed to be taken out of service by 2005.
6. Criteria utilized to determine storage requirements for the Western Third Zone are taken from the 1955 Geyer-Wolff Report and are as follows:
 - a. Provide storage to meet daily demand fluctuations in the Western Third Zone (equal to 20% of the maximum day's demand in the Western Third Zone).

- b. Provide fire fighting reserve of 4.8 million gallons (8 hours flow duration at a flow rate of 10,000 gallons per minute).
 - c. Provide reserve equal to one-half of one day's demand in the Western Third Zone at the annual average demand rate in that zone.
 - d. For the dependent higher zones that have no ground storage, provide reserve for fire fighting (if not available in the higher zone) and for one half day's demand at the annual average rate. Fire fighting reserve is available in the Catonsville Fourth, Pikesville Fourth, and Reisterstown Fifth higher zones.
6. For projected flows the following ratios were assumed for each party relating maximum day demand to average day demand:

BALTIMORE CITY	(for years 2000 and 2025)	1.3
BALTIMORE COUNTY, all zones except Catonsville Fourth Zone	(for years 2000 and 2025)	1.6
BALTIMORE COUNTY, Catonsville Fourth Zone	(for years 2000 and 2025)	1.5
HOWARD COUNTY	(for years 1990, 1995, 2000, 2005, and 2025)	1.7

B. Average day demand projections for each party

	1980	1990	YEAR 1995	2000	2005	2025
BALTIMORE CITY	28.35	27.34	26.84	26.34	26.41	26.70
BALTIMORE COUNTY	23.32	27.62	29.77	31.92	33.54	40.00
HOWARD COUNTY	7.1	13.3	14.9	17.5	19.9	29.7
TOTAL AVERAGE DAY DEMAND	58.77	68.26	71.51	75.76	79.85	96.40

All flows above are given in units of million gallons per day.

C. Maximum day demand projections for each party

	1980	1990	YEAR 1995	2000	2005	2025
BALTIMORE CITY	32.03	33.13	33.69	34.24	34.33	34.71
BALTIMORE COUNTY	11.60	13.80	14.90	16.00	16.00	16.00
WESTERN THIRD ZONE						
BALTIMORE COUNTY UPPER ZONES	22.20	28.16	31.14	34.12	36.70	46.98
HOWARD COUNTY	11.18	22.61	25.33	29.75	33.83	50.50
TOTAL MAXIMUM DAY DEMAND	77.01	97.70	105.06	114.11	120.85	148.19

All flows above are given in units of million gallons per day.

D. Storage projections for each party

	1980	1990	YEAR 1995	2000	2005	2025
<u>BALTIMORE CITY:</u>						
Daily fluctuations reserve	6.41	6.63	6.74	6.85	6.87	6.94
1/2 average day reserve	14.17	13.67	13.42	13.17	13.20	13.35
Fire fighting reserve	2.4	2.4	2.4	2.4	2.4	2.4
BALTIMORE CITY Totals	22.98	22.70	22.56	22.42	22.47	22.69
<u>BALTIMORE COUNTY:</u>						
Daily fluctuations reserve (Western Third Zone Only)	2.32	2.76	2.98	3.2	3.2	3.2
1/2 average day reserve (Western Third and Upper Zones)	11.66	13.81	14.88	15.96	16.77	20.00
Fire fighting reserve	2.4	2.4	2.4	2.4	2.4	2.4
BALTIMORE COUNTY Totals	16.38	18.97	20.26	21.56	22.37	25.60
<u>HOWARD COUNTY:</u>						
Daily fluctuations reserve	2.24	4.52	5.07	5.95	6.77	10.10
1/2 average day reserve	3.55	6.65	7.45	8.75	9.95	14.85
HOWARD COUNTY Totals	5.79	11.17	12.52	14.70	16.72	24.95
Total Storage Required	45.15	52.84	55.34	58.68	61.56	73.24

All storage volumes are given in units of million gallons.

E. Projected storage to be supplied by the Catonsville Reservoir

	1980	1990	YEAR 1995	2000	2005	2025
TOTAL STORAGE REQUIRED	45.15	52.84	55.34	58.68	61.56	73.24
AVAILABLE STORAGE WITHOUT CATONS- VILLE RESERVOIR	25.40	25.40	25.40	25.40	21.40	21.40
DIFFERENCE = CATONSVILLE RESERVOIR STORAGE	19.75	27.44	29.94	33.28	40.16	51.84

All storage volumes are given in units of million gallons.

AGREEMENT ATTACHMENT NO. 3

DERIVATION OF COST SHARE RATIOS FOR JOINTLY USED FACILITIES

A. Catonsville Transmission Main, Section 2

Total maximum day flow in parallel main for design year 2025 = 46.28 mgd

Howard County maximum day flow to U. S. Route 40 and Gun Road connections for design year 2025 = 50.50 mgd

Maximum day flow allowed to Howard County by November 6, 1957 Agreement = 8.50 mgd

Maximum day capacity required by Howard County = 50.50 mgd - 8.50 mgd = 42.00 mgd

Howard County cost share ratio in parallel main = $\frac{42.00}{46.28}$ = 90.75%

Baltimore County cost share ratio in parallel main = $100 - 90.75$ = 9.25%

B. Catonsville Transmission Main, Section 4

Total maximum day flow in parallel main and existing main for design year 2025 = 48.80 mgd

This main serves only Howard County and is, therefore, funded by Howard County at the 100% level

C. Catonsville Reservoir, East Bay

The East Bay is to provide adequate storage until such time as the reservoir West Bay is constructed.

1. Based on Attachment No. 2, Item E, determine the year in which the total storage provided by the Catonsville Reservoir East Bay will be fully utilized. Assume a linear increase in storage requirements for years between the five year increments given. The year so determined is the year by which the Reservoir West Bay must be constructed.
2. From Attachment No. 2, Item D, obtain the storage requirements for each party for the five year increments which immediately precede and follow the year determined in Step (1) above.

3. Assuming that storage requirements for each party increase linearly for years between the five year increments identified in Step (2) above, calculate each party's storage requirements for the year determined in Step (1) above. To simplify the explanation of the following calculations, assume Baltimore City's storage requirements = (A); Baltimore County's storage requirements = (B); and Howard County's storage requirements = (C).
4. Total existing storage available prior to construction of the Reservoir East Bay is as follows:

Pikesville Reservoir	=	21.40 MG
Melvin Avenue Tank	=	<u>4.00 MG</u>
TOTAL =		25.40 MG

5. Portion of existing storage (Pikesville Reservoir and Melvin Avenue Tank) available for use by Baltimore County prior to construction of the Reservoir West Bay = 25.40 MG - (A) = (D).

Where: (D) - is the portion of existing storage available for use by Baltimore County.

6. Additional storage in East Bay required by Baltimore County = (B) - (D) = (E).

Where: (E) is the East Bay storage required by Baltimore County.

7. Storage in East Bay required by Howard County = (C).
8. Baltimore County cost share ratio in East Bay = (E) / total storage provided by East Bay.
9. Howard County cost share ratio in East Bay = (C) / total storage provided by East Bay.

D. Leakin Park Pumping Station

Howard County maximum day flow to U. S. Route 40 and Gun Road connections for design year 2025 = 50.5 mgd

Maximum day flow allowed to Howard County by November 6, 1957 agreement = 8.50 mgd

Maximum day capacity required in Leakin Park Pumping Station by Howard County = 50.5 MGD - 8.50 mgd = 42.00 mgd

Baltimore City maximum day flow for design year 2025, to be supplied by Ashburton Pumping Station = 34.71 mgd

Baltimore County maximum day flow for design year 2025 = 62.98 mgd

Portion of Baltimore County maximum day flow for design year 2025 to be provided by Ashburton Pumping Station = (A) - (8.50 mgd + 34.71 mgd) = (B)

Where: (A) - is the maximum day flow capacity of the Ashburton Pumping Station in the design year 2025 as determined by the Water Analyzer Office using pump curves for the Leakin Park Pumping Station specified in the engineering design study prepared by Baltimore City.

(B) - is the portion of the Baltimore County maximum day flow for design year 2025 to be provided by Ashburton Pumping Station.

Portion of Baltimore County maximum day flow for design year 2025 to be provided by Leakin Park Pumping Station = 62.98 mgd - (B) = (C)

Where: (C) - is the portion of the Baltimore County maximum day flow for design year 2025 to be provided by Leakin Park Pumping Station.

Total maximum day flow from Leakin Park Pumping Station in 2025 = 42.00 mgd + (C) = (D)

Where: (D) - is the total maximum day flow from Leakin Park Pumping Station in 2025

Baltimore County cost share percentage in Leakin Park Pumping Station = $[(C)/(D)] \times 100\%$

Howard County cost share percentage in Leakin Park Pumping Station = $[42.00/(D)] \times 100\%$

E. Catonsville Transmission Main, Section 1-S

Since this main consists of the suction and discharge mains for the Leakin Park Pumping Station, cost share ratios are as given in Item (D) for the Pumping Station

F. Melvin Avenue Transmission Main, Cleaning and Lining

Total maximum day flow in main for design year 2025 = 4.77 mgd

Howard County maximum day flow in main for design year 2025 = 1.70 mgd

Baltimore County maximum day flow in main for design year 2025 = 3.07 mgd

Howard County cost share ratio in cleaning and lining = $1.70 \text{ mgd} / 4.77 \text{ mgd}$ = 35.64%

Baltimore County cost share ratio in cleaning and lining = $3.07 \text{ mgd} / 4.77 \text{ mgd}$ = 64.36%

G. Harlem Lane Transmission Main, Cleaning and Lining

Total maximum day flow in main for design year 2025 = 1.88 mgd

Howard County maximum day flow in main for design year 2025 = 0.67 mgd

Baltimore County maximum day flow in main for design year 2025 = 1.21 mgd

Howard County cost share ratio in cleaning and lining = $0.67 \text{ mgd} / 1.88 \text{ mgd}$ = 35.64%

Baltimore County cost share ratio in cleaning and lining = $1.21 \text{ mgd} / 1.88 \text{ mgd}$ = 64.36%

H. Rolling Road Transmission Main, Cleaning and Lining

Total maximum day flow in main for design year 2025 = 4.97 mgd

Howard County maximum day flow in main for design year 2025 = 1.70 mgd

Baltimore County maximum day flow in main for design year 2025 = 3.27 mgd

Howard County cost share ratio in cleaning and lining = $1.70 \text{ mgd} / 4.97 \text{ mgd}$ = 34.21%

Baltimore County cost share ratio in cleaning and lining = $3.27 \text{ mgd} / 4.97 \text{ mgd}$ = 65.79%

EXHIBIT 4

**1988 WSSC &
Howard County Water Agreement**

AGREEMENT

THIS AGREEMENT, made this 16 day of June, 1988, by and between the Washington Suburban Sanitary Commission, hereinafter referred to as WSSC; and Howard County, Maryland, a body corporate and politic of the State of Maryland, hereinafter referred to as HOWARD COUNTY.

WHEREAS, the General Assembly of the State of Maryland has established through Legislative Acts, as specified in the Annotated Code of Maryland, Article 29, Title 15, that WSSC may enter into any contract or agreement with the HOWARD COUNTY Department of Public Works to furnish water to HOWARD COUNTY; and

WHEREAS, WSSC and HOWARD COUNTY entered into an agreement dated October 25, 1954, hereinafter referred to as the "1954 Agreement", for the purpose of extending water supply mains and constructing appurtenant works for furnishing water from the WSSC water distribution system to HOWARD COUNTY; and

WHEREAS, both WSSC and HOWARD COUNTY constructed water supply mains and appurtenant works described in the 1954 Agreement; and

WHEREAS, under the terms of the 1954 Agreement, WSSC was to maintain and operate those portions of the water system of HOWARD COUNTY which were supplied from the water system to WSSC; and

WHEREAS, under the terms of the 1954 Agreement, WSSC agreed to furnish HOWARD COUNTY not more than 2.5 million gallons of potable water per day, and HOWARD COUNTY desires to increase this daily flow limitation to accommodate future water demands in HOWARD COUNTY; and

WHEREAS, there have been substantial changes in responsibilities for construction, operation, and maintenance of the portion of HOWARD COUNTY'S water system which is supplied by the WSSC water system, thus rendering the 1954 Agreement obsolete.

NOW, THEREFORE, THIS AGREEMENT WITNESSETH; that in consideration of the covenants, agreements, and payments set forth herein, it is mutually covenanted and agreed as follows:

ARTICLE I - DEFINITION

1. "Party or Parties" shall mean WSSC and/or HOWARD COUNTY, as appropriate, each being a signatory to this Agreement.
2. "Capital Costs" is the net cost involved in the construction of a water supply facility and shall include, but not be limited to, the sum of the following items: Land and/or easements; consultants' fees including those for design and inspection; material; labor; utility relocations; overhead which may include a proportionate allocation of in-house costs associated with design, field engineering, surveys, borings, materials testing, maps and records maintenance, inspection, right-of-way expenses, advertising, administrative services, clerical services, stenographic services, office space use and building operation and maintenance; and all other contributing costs or expenses. Capital cost does not include operation and maintenance costs incurred after the completion and final acceptance of the facility.
3. "12-Inch Water Main" is the proposed 12-inch diameter water main located along Montgomery Street in Laurel from Eleventh Street to Woodview Terrace, a distance of approximately 1,230 linear feet. The general location of this main is shown on the attached map included as Attachment No. 1 to this Agreement.
4. "Public Water System" is the system of water lines, storage tanks, pumping stations and other appurtenant structures for the purpose of distributing potable water to the public.
5. "Maximum Daily Rate" is the maximum volume of water which passes through the interconnection between consecutive midnights.

ARTICLE II - DESIGN, CONSTRUCTION, INSPECTION AND FUNDING OF IMPROVEMENT TO THE WSSC WATER SYSTEM REQUESTED BY HOWARD COUNTY

1. The WSSC shall proceed with design and construction of the 12-inch water main on a schedule to be coordinated with the City of Laurel. The capital cost of the 12-inch water main shall be paid by HOWARD COUNTY.

2. HOWARD COUNTY agrees to advance funds to WSSC equal to 25% of the estimated capital cost of the 12-inch water main. HOWARD COUNTY shall advance these funds prior to the acceptance of construction bids by WSSC. The estimated capital cost is \$80,000.
3. The WSSC shall submit billings and provide updates of the estimated total cost at the following stages of project completion; 25%, 50%, and 75%.
4. WSSC shall, upon completion of construction of the 12-inch water main, prepare a final billing of the total actual capital costs, less the funds previously advanced by HOWARD COUNTY. HOWARD COUNTY shall, upon receipt of the final accounting and final billing from WSSC, pay any balance due for the capital cost. HOWARD COUNTY shall have the right, prior to payment of the final billing, to independently review the statements and accounts of WSSC related to the construction of the 12-inch water main. The review or audit shall be made at the expense of HOWARD COUNTY and shall be made available to WSSC upon completion.
5. HOWARD COUNTY shall make complete payments for all billings within 30 days of receipt.
6. The 12-inch water main shall be designed, constructed and tested in accordance with the applicable codes, rules and regulations of WSSC.
7. HOWARD COUNTY shall have the right to review reports, plans, specifications and bids for the construction of the 12-inch water transmission main. Said documents, including significant revisions, shall not be approved without the consent of HOWARD COUNTY. Any costs incurred for said review shall be borne exclusively by HOWARD COUNTY. The 12-inch water transmission main shall be constructed in accordance with the approved plans and specifications.

ARTICLE III - OWNERSHIP AND MAINTENANCE RESPONSIBILITY

1. WSSC shall own the 12-inch water main constructed under the terms of this Agreement. HOWARD COUNTY shall own all portions of the public water system located in HOWARD COUNTY which are necessary to transport water supplied to HOWARD COUNTY by WSSC. HOWARD COUNTY shall expand and

improve the public water system in HOWARD COUNTY at no cost to WSSC, and in accordance with the applicable codes, rules, and regulations of HOWARD COUNTY.

2. WSSC shall be responsible for and shall supervise the operation and maintenance of the public water system located within the Washington Suburban Sanitary District. In addition, WSSC shall be responsible for and shall supervise the operation and maintenance of the metering facilities located on Summit Avenue in HOWARD COUNTY near the HOWARD COUNTY boundary. Should it become necessary for WSSC to replace the existing meter or related equipment, the replacement meter or equipment shall be approved by HOWARD COUNTY, prior to installation. In the event of failure of the meter or related equipment, WSSC will proceed as promptly as possible with repairs. WSSC shall operate and maintain the public water system in the Washington Suburban Sanitary District, and the metering facilities located in HOWARD COUNTY, at no cost to HOWARD COUNTY other than those costs described in Article IV below.
3. HOWARD COUNTY shall be responsible for and shall supervise the operation and maintenance of the public water system located within HOWARD COUNTY. HOWARD COUNTY shall operate and maintain the public water system in HOWARD COUNTY at no cost to WSSC.

ARTICLE IV - WATER SUPPLY LIMITATIONS & PAYMENT FOR WATER FURNISHED

1. WSSC agrees to furnish potable water to HOWARD COUNTY through the connection between the public water systems of WSSC and HOWARD COUNTY as identified on Attachment No. 1 to this Agreement. Potable water shall be furnished at a maximum daily rate not to exceed 5.0 million gallons per day. The maximum daily rate will be supplied to the interconnection at a minimum hydraulic grade of 330 feet under normal operating conditions. The WSSC will be responsible for identifying and resolving conditions under which the minimum hydraulic grade cannot be maintained. If maintaining the minimum hydraulic grade requires construction of additional water system facilities, the parties will enter into an agreement for sharing the cost of those facilities. HOWARD COUNTY will

be responsible for ensuring that the peak instantaneous flow through the interconnection does not exceed the maximum daily rate, except for a margin attributable to the vagaries of pump operation.

2. HOWARD COUNTY will be responsible for the installation and maintenance of devices which provide effective back flow prevention for the interconnection.
3. In the event of a water supply emergency in the WSSC system, the WSSC may request that Howard County provide a reverse supply through the interconnection at a rate to be determined by Howard County. The WSSC will provide payment for such water in a manner identical to the payments made by Howard County for WSSC water.
4. HOWARD COUNTY shall purchase the potable water supplied by WSSC. The rate of payment shall reflect the cost incurred by WSSC to provide potable water to HOWARD COUNTY, exclusive of costs such as those for meter maintenance, meter reading, and customer billing which are not incurred by WSSC in supplying water to HOWARD COUNTY. The rate of payment will initially be seventy percent (70%) of the prevailing rate WSSC charges a customer having an average daily consumption of 240 gallons. The rate of payment shall be reviewed every five years by the WSSC and shall be adjusted as necessary to conform with the terms of this Agreement. HOWARD COUNTY shall have the right to review or audit the statements and accounts of WSSC related to the setting of the rate of payment. Such a review or audit shall be made at the expense of HOWARD COUNTY and shall be made available to WSSC upon completion.
5. HOWARD COUNTY shall make monthly payments to the WSSC based on the volume of water furnished to HOWARD COUNTY as recorded by the Summit Avenue water meter. WSSC shall bill HOWARD COUNTY monthly, indicating the amount due and the volume of water used. In the absence of an accurate meter reading, the volume of water furnished to HOWARD COUNTY shall be estimated based on previous meter readings.

ARTICLE V - FUTURE ADDITIONAL INTERCONNECTIONS

1. HOWARD COUNTY intends to request additional interconnections with the WSSC in the future. The total supply requested by HOWARD COUNTY from the WSSC may increase to 10 mgd or more. The WSSC will review any such requests according to the precedents established for this Agreement and any appropriate additional considerations.
2. Both parties shall explore, and if mutually agreeable, proceed with projects which provide the ability for increased emergency supply of water to either jurisdiction.

ARTICLE VI - RIGHTS AND LIMITATIONS

1. Nothing in this Agreement shall limit or abrogate any right or rights of any party to enter into other separate agreements for the planning, design and construction of water supply facilities providing such separate agreements do not conflict with this agreement.
2. Nothing contained in this Agreement shall limit or abrogate any right or rights delegated to each party by Acts of the General Assembly of the State of Maryland.
3. Nothing contained in this Agreement shall be construed to abridge or restrict the police, legislative or governmental powers of any party to this agreement.
4. Each party shall recognize all rights and privileges acquired by another party through the acquisition of property and/or rights-of-way.
5. The Agreement dated October 25, 1954 between WSSC and HOWARD COUNTY is hereby replaced by this Agreement.
6. The terms and conditions provided for this Agreement shall continue in full force and effect until the parties amend this Agreement or execute a new replacement agreement.
7. WSSC shall not be responsible for its inability to furnish water to HOWARD COUNTY as provided in this agreement due to an emergency arising from a break in WSSC's public water system or other emergency condition. In such event, however, WSSC will take whatever action may be necessary to restore service as promptly as possible.

8. Should it become necessary for WSSC to impose water use restrictions within the Washington Suburban Sanitary District, the amount of water furnished under this Agreement may be reduced as applicable to other WSSC customers.

ARTICLE VII - AMENDMENT OF THE AGREEMENT

1. Any increases above the maximum daily rate of 5.0 million gallons per day to HOWARD COUNTY or to provide for increased emergency supply of water to either jurisdiction shall be by amendment to this Agreement.

IN WITNESS WHEREOF, the parties hereto have properly executed this Agreement, as of the day, month, and year first above written.

ATTEST:

WASHINGTON SUBURBAN SANITARY COMMISSION

Timothy A. Firrell

By: Robert Stinson
General Manager

ATTEST:

William E. Eable

By: Elizabeth Bolso
County Executive

APPROVED AS TO FORM AND
LEGAL SUFFICIENCY:

Approved:

Barbara M. Cook 6/15/88
County Solicitor

James P. Lewis 6/14/88
Director of Public Works

SECOND ADDENDUM TO AGREEMENT

THIS SECOND ADDENDUM (the "Second Addendum") is made this 24th day of August, 2009, by and between the Washington Suburban Sanitary Commission, hereinafter referred to as "WSSC", and Howard County, Maryland, a body corporate and politic of the State of Maryland, hereinafter referred to as "HOWARD COUNTY".

WHEREAS, WSSC and HOWARD COUNTY entered into an agreement dated June 16, 1988 (the "Agreement") for the purpose of extending water supply mains and constructing appurtenant works for furnishing water from the WSSC water distribution system to HOWARD COUNTY; and

WHEREAS, under the terms of the Agreement, WSSC agreed to furnish HOWARD COUNTY with up to 5.0 million gallons of potable water per day, but HOWARD COUNTY has not been purchasing its full allotment due to the higher cost of WSSC's water compared to that of HOWARD COUNTY'S other main supplier, Baltimore City; and

WHEREAS, pursuant to an addendum to the Agreement, dated October 6, 2008 (the "First Addendum"), HOWARD COUNTY conducted a pilot program for a period of six months, during which time it tested the capacity of its current equipment and facilities to determine what portion of its current allotment it could guarantee to utilize on a daily basis. During this pilot period, WSSC charged HOWARD COUNTY the same wholesale service rate that HOWARD COUNTY pays to Baltimore City; and

WHEREAS, HOWARD COUNTY will agree herein to purchase a Minimum Daily Rate (defined below), if WSSC agrees to charge a billing rate for the water that is comparable to that of Baltimore City's billing rate.

NOW, THEREFORE, in consideration of the foregoing, and the terms and conditions set forth herein, the parties agree that the Agreement is amended as follows:

1. All capitalized terms not defined herein shall have the same meaning ascribed to them in the Agreement.
2. The Agreement hereby is amended as follows:
 - a. The First Addendum is superseded by this Second Addendum.
 - b. Section 1 of Article IV of the Agreement is amended by deleting the second and third sentences in said section and inserting the following sentences in their place:

For each full day that WSSC furnishes water, HOWARD COUNTY shall purchase a minimum of 2.5 million gallons per day (the "Minimum Daily Rate"), regardless of its actual draw, but will purchase no greater than the 5.0 million gallons Maximum Daily Rate established in the Agreement. The "Minimum Daily Rate" will be calculated as a monthly daily average beginning at midnight of the 1st day of the month and ending at midnight of the last day of the month. Howard County shall not be required to purchase any minimum amount of water for any day that (i)

WSSC furnishes water for less than a full day, or (ii) WSSC provides a restricted water supply at any time during the same period of time, or (iii) WSSC and HOWARD COUNTY mutually agree to waive the minimum purchase. In such event, the Minimum Daily Rate for that month shall be adjusted by eliminating that day. WSSC shall supply daily at the least the Minimum Daily Rate and all water shall be supplied to the interconnections at a minimum hydraulic grade of 330 feet under normal operating conditions.

c. Section 4 of Article IV of the Agreement is deleted in its entirety and replaced by the following paragraph:

WSSC agrees to set its current billing rate for all potable water supplied to HOWARD COUNTY at the "Wholesale Service Rate" charged HOWARD COUNTY by Baltimore City for each billing period, beginning at \$1304.80 per million gallons. HOWARD COUNTY agrees to promptly notify WSSC of any changes in Baltimore City's billing rate and, annually on June 30, provide certification to WSSC of the current Baltimore City rate. All such changes in Baltimore City's billing rate will be applied retroactively to WSSC's billing rate as of the date of the Baltimore City rate change. HOWARD COUNTY shall have the right to review and audit the statements and accounts of WSSC related to the supply of and billing for the potable water. Such a review or audit shall be made at the expense of HOWARD COUNTY and shall be made available to WSSC upon completion. WSSC shall have the right to review and audit the statements and accounts of HOWARD COUNTY related to the supply of and billing for the potable water, and such a review or audit shall be made at the expense of WSSC and made available to HOWARD COUNTY upon completion.

3. These changes shall be effective as of April 1, 2009. The parties agree to review the Minimum Daily Rate, Maximum Daily Rate and billing rate at least once every five years, or earlier upon request of either party. Any further amendments to the Agreement, as amended hereby, shall be in writing and only effective if signed by all of the parties.

4. All terms and conditions of the Agreement not modified hereby are ratified and confirmed.

[Signatures follow on next page.]

IN WITNESS WHEREOF, the parties hereto have properly executed this Agreement, as of the date first above written.

**WASHINGTON SUBURBAN
SANITARY COMMISSION**

**Approved As To Form and
Legal Sufficiency:**

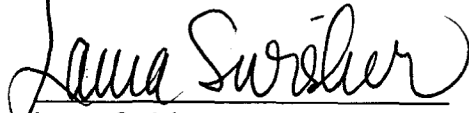

Laura Swisher
Associate Counsel II

Approval Recommended:

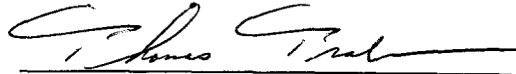

Thomas Traber
Chief Financial Officer

ATTEST:

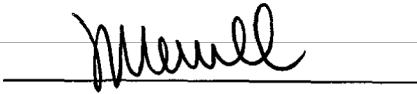

Approved:

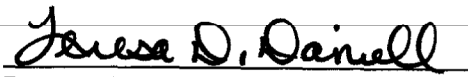

Teresa D. Daniell
Interim General Manager

WITNESS/ATTEST:

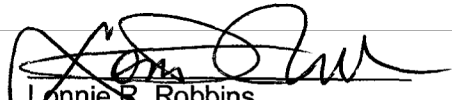

Lonnie R. Robbins
Chief Administrative Officer

HOWARD COUNTY, MARYLAND

BY:  (SEAL)

Ken Ulman
County Executive

APPROVED:



James M. Irvin, Director
Department of Public Works

APPROVED FOR SUFFICIENCY OF FUNDS:



Sharon F. Greisz, Director
Department of Finance

APPROVED FOR FORM AND LEGAL SUFFICIENCY

this 20th day of September, 2009:

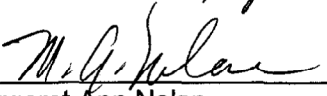

Margaret Ann Nolan
County Solicitor 

EXHIBIT 5

**2014 Water Quality Report &
Water Monitoring Data**

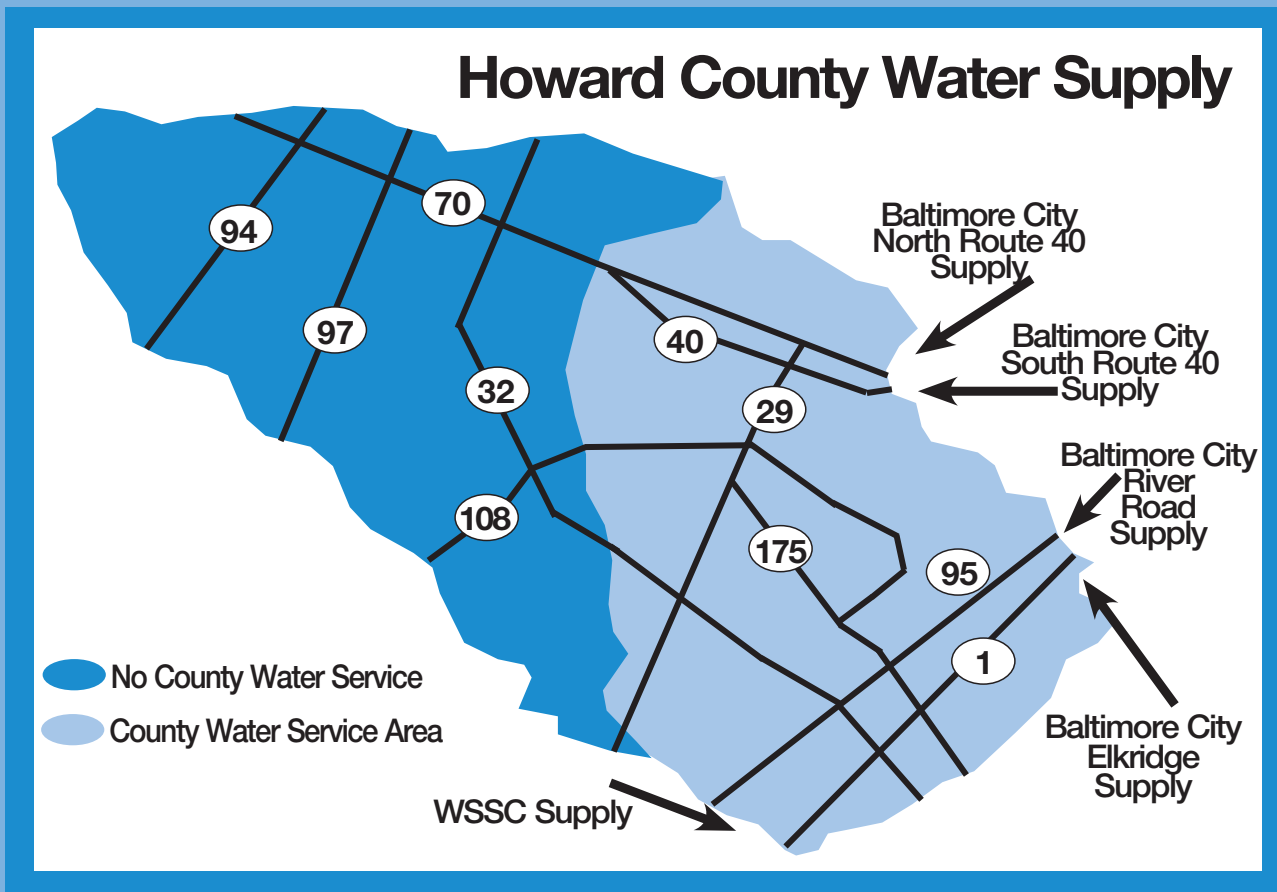

WHERE YOUR WATER COMES FROM

If you live in the North Laurel area, east of Interstate 95 and south of Patuxent Range Road, your water originates from the Washington Suburban Sanitary Commission in Laurel. If you live anywhere else in Howard County and are connected to the public water supply, your water originates from Baltimore City. As a "Consecutive Water System," Howard County purchases water from Baltimore City and the Washington Suburban Sanitary Commission. Most of the analyses are performed at their water quality laboratories. The table inside this brochure shows the results of monitoring for the period of January 1st to December 31st, 2013.

Waivers

The Maryland Department of the Environment has granted the City of Baltimore monitoring waivers for the following compounds: 2,3,7,8-TCDD (Dioxin), Endothall, Diquat, Glyphosphate, Asbestos and Cyanide.

LEAD AND COPPER TESTING - HOWARD COUNTY

The EPA requires the County to sample the water distribution system and test these samples for lead and copper. Under these requirements no more than 10% of samples can have lead and/or copper levels above the Action Level shown below. The results of the County's sampling of 50 sites conducted in 2011 are shown below. The next schedule sampling for Lead and Copper will be performed during the summer of 2014.

Contaminant	Action Level	90th Percentile Value
Lead	15 ppb	3.2
Copper	1.3 ppm	0.11

"If present, elevated levels of lead can cause serious health problems, especially for pregnant women and young children. Lead in drinking water is primarily from materials and components associated with service lines and home plumbing. Howard County's Bureau of Utilities is responsible for providing high quality drinking water, but cannot control the variety of materials used in plumbing components. When your water has been sitting for several hours, you can minimize the potential for lead exposure by flushing your tap for 30 seconds to 2 minutes before using water for drinking or cooking. If you are concerned about lead in your drinking water, you may wish to have your water tested. Information on lead in drinking water, testing methods, and steps you can take to minimize exposure is available from the EPA Safe Drinking Water Hotline at 1-800-426-4791 or at <http://water.epa.gov/drink/info/lead/>."

For More Information

If you have any questions about this report or concerning your water utility, please contact Howard County Utilities at 410-313-4900. We want our valued customers to be informed about their water utility. If you want to learn more, please attend any of our regularly scheduled Department of Public Works Board meetings. Please call 410-313-2330 for further information about these meetings.

Employees at Howard County Utilities work around the clock to provide top quality water to every tap. We ask that all our customers help us protect our water sources, which are the heart of our community, our way of life and our children's future.

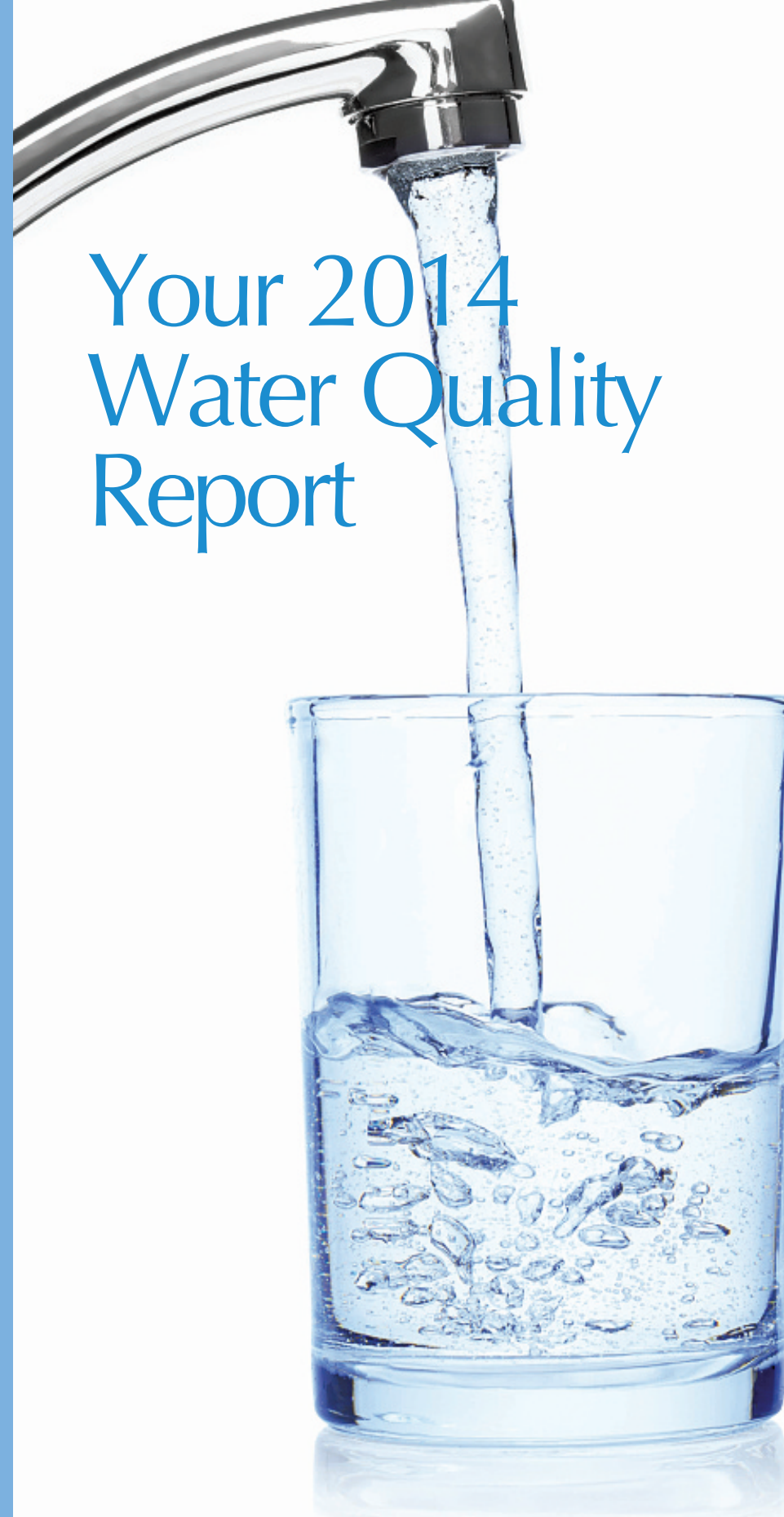

Your 2014 Water Quality Report

HOWARD COUNTY,
MARYLAND - PSWID 0130002
JULY 1, 2014

Howard County is pleased to present to you this year's Water Quality Report. This report is designed to inform you about the quality water and services we deliver to you every day. Our constant goal is to provide you with a safe and dependable supply of drinking water. We want you to understand the efforts our water suppliers make to continually improve the water treatment process and protect our water resources. We are committed to ensuring the quality of your water. Our water sources are surface water from the Liberty Reservoir on the North Branch of the Patapsco River, and the Loch Raven Reservoir on the main stream of the Gunpowder Falls purchased from Baltimore City, and surface water from the Patuxent River purchased from the Washington Suburban Sanitary Commission.

CLEAN FRESH WATER



Clean, fresh water is essential to our survival and one of our most precious resources. As consumers, you have the right to be informed about the quality of the water that comes to you through your tap.

This annual Water Quality Report has information about where your water comes from, why we test it and the results of those tests which clearly show that our water is safe.

Protecting Howard County's water supply and maintaining the public water delivery system is a responsibility the men and women of the Bureau of Utilities take very seriously. They do an outstanding job, and I want to thank them for all they do to make sure your water is of the highest quality.

Ken Ulman, Howard County Executive

DEAR VALUED CUSTOMER,

Howard County residents and guests continue to enjoy a high quality drinking water. The employees of Howard County's Bureau of Utilities, Department of Public Works, labor tirelessly to serve you, our customers, as dedicated stewards of this critical service. Our mission is to provide high quality, safe, and dependable drinking water. Our staff works around the clock, through all weather conditions to assure we meet this mission. Increased efforts are continuing to keep our infrastructure and systems upgraded. We hope you find this report informative and reassuring. Please do not hesitate in contacting your Howard County drinking water team at 410-313-4900 for more information. It is a pleasure serving you and please always exercise caution when driving around our crews working in or near traffic.

Stephen Gerwin, PE
Chief, Bureau of Utilities

WHY WATER IS TESTED:

All sources of drinking water are subject to potential contamination by substances that are naturally occurring or man made. These substances can be microbes, inorganic or organic chemicals and radioactive substances. As water travels over the land or underground, it can pick up substances or contaminants such as microbes, inorganic and organic chemicals, and radioactive substances. All drinking water, including bottled drinking water, may be reasonably expected to contain at least small amounts of some contaminants. The presence of contaminants does not necessarily indicate that the water poses a health risk.

Contaminants that may be present in source water include:

- Microbial contaminants, such as viruses and bacteria, which may come from sewage treatment plants, septic systems, agricultural livestock operations, and wildlife.
- Inorganic contaminants, such as salts and metals, which can be naturally occurring or result from urban storm water runoff, industrial or domestic wastewater discharges, oil and gas production, mining, or farming.
- Pesticides and herbicides, which may come from a variety of sources such as agriculture, urban storm water runoff, and residential uses.
- Organic chemical contaminants, including synthetic and volatile organic chemicals, which are by-products of industrial processes and petroleum production, and can also come from gas stations, urban storm water runoff, and septic systems.
- Radioactive contaminants, which can be naturally occurring or be the result of oil and gas production and mining activities.

To ensure that tap water is safe to drink, the Environmental Protection Agency (EPA) sets regulations that limit the amount of certain contaminants in water provided by public water systems. Food and Drug Administration (FDA) regulations set limits for contaminants in bottled water that must provide the same protection for public health.

The Maryland Department of the Environment (MDE) has completed a Source Water Assessment of the water supplies that serve the City of Baltimore. In general, contamination of water supplies can come from several natural and manmade sources. As water travels over the surface of the land it dissolves naturally occurring minerals and, in some cases, radioactive material, and can pick up substances resulting from the presence of animals or from human activity. The Source Water Assessment Program may be viewed at the MDE web site, http://www.mde.maryland.gov/programs/water/water_supply/source_water_assessment_program/pages/programs/waterprograms/water_supply/sourcewaterassessment/index.aspx.

More information about contaminants and potential health effects can be obtained by calling the Environmental Protection Agency's Safe Drinking Water Hotline at 1-800-426-4791.

TABLE KEY

In this table you will find many terms and abbreviations you might not be familiar with. To help you better understand these terms we've provided the following definitions:

Non-Detects (ND) - laboratory analysis indicates that the constituent is not detectable by the analytical instrument used

Parts per million (ppm) or Milligrams per liter (mg/l) - one part per million corresponds to one minute in two years or a single penny in \$10,000.

Parts per billion (ppb) or Micrograms per liter (ug/l) - one part per billion corresponds to one minute in 2,000 years, or a single penny in \$10,000,000.

Parts per trillion (ppt) or Nanograms per liter (nanograms/l) - one part per trillion corresponds to one minute in 2,000,000 years, or a single penny in \$10,000,000,000.

Parts per quadrillion (ppq) or Picograms per liter (picograms/l) - one part per quadrillion corresponds to one minute in 2,000,000,000 years or one penny in \$10,000,000,000,000.

Picocuries per liter (pCi/L) - picocuries per liter is a measure of the radioactivity in water.

Millirems per year (mrem/yr) - measure of radiation absorbed by the body.

Million Fibers per Liter (MFL) - million fibers per liter is a measure of the presence of asbestos fibers that are longer than 10 micrometers.

Nephelometric Turbidity Unit (NTU) - nephelometric turbidity unit is a measure of the clarity of water. Turbidity in excess of 5 NTU is just noticeable to the average person.

Treatment Technique (TT) - A treatment technique is a required process intended to reduce the level of a contaminant in drinking water.

Maximum Contaminant Level - The "Maximum Allowed" (MCL) is the highest level of a contaminant that is allowed in drinking water. MCLs are set as close to the MCLGs as feasible using the best available treatment technology.

Maximum Contaminant Level Goal - The "Goal" (MCLG) is the level of a contaminant in drinking water below which there is no known or expected risk to health. MCLGs allow for a margin of safety.

Variances & Exemptions (V&E) - State or EPA permission not to meet an MCL or a treatment technique under certain conditions. **Action Level** - the concentration of a contaminant which, if exceeded, triggers treatment or other requirements which a water system must follow.

Some people may be more vulnerable to contaminants in drinking water than the general population. Immuno-compromised persons such as persons with cancer undergoing chemotherapy, persons who have undergone organ transplants, people with HIV/AIDS or other immune system disorders, some elderly, and infants can be particularly at risk from infections. These people should seek advice about drinking water from their health care providers. EPA/CDC guidelines on appropriate means to lessen the risk of infection by cryptosporidium and other microbiological contaminants are available from the **Safe Drinking Water Hotline at 1-800-426-4791**.

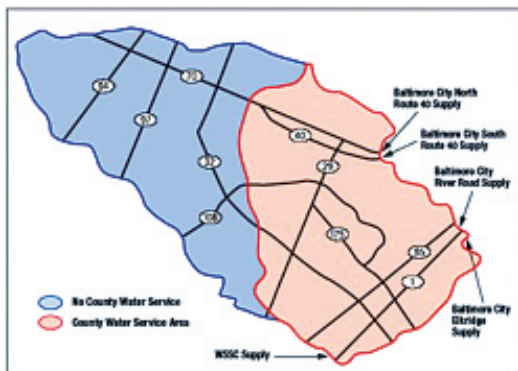

TEST RESULTS – HOWARD COUNTY - PSWID 0130002										
Contaminant	Violation Y/N	Level Detected	Range	MCLG	MCL			Likely Source of Contamination		
Microbiological Contaminants										
Total Coliform Bacteria	N	0.32%	0.0–1.30%	0		presence of coliform bacteria in 5% of monthly samples		Naturally present in the environment		
Fecal Coliform and <i>E. coli</i>	N	ND	0	0		a routine sample and repeat sample are total coliform positive, and one is also fecal coliform or <i>E. coli</i> positive		Human and animal fecal waste		
TEST RESULTS – OUR SUPPLIERS										
	Baltimore City Supply				Washington Suburban Sanitary Commission Supply					
	Ashburton Plant		Montebello Plant							
Contaminant - Units	Violation Y/N	Level Detected	Violation Y/N	Level Detected	Violation Y/N	Level Detected	MCLG	MCL	Likely Source of Contamination	
Microbiological Contaminants										
Turbidity - NTU	N	0.08	N	0.19	N	0.03	1.00	1.00	1.00	Soil runoff
Radioactive Contaminants										
Beta/photon emitters pCi/l	N	<1.5	N	<1	N	4.1	0	50	Decay of natural and man-made deposits	
Alpha emitters pCi/l	N	<1	N	<1	N	<2	0	15	Erosion of natural deposits	
Inorganic Contaminants										
Antimony - ppb	N	<5	N	<5	N	ND	6	6	Discharge from petroleum refineries; fire retardants; ceramics; electronics; solder	
Arsenic - ppb	N	<2	N	<2	N	ND	0	10	Erosion of natural deposits; runoff from orchards; runoff from glass And electronics production wastes	
Barium - ppm	N	0.02	N	0.03	N	0.024	2	2	Discharge of drilling wastes; discharge from metal refineries; erosion of natural deposits	
Beryllium - ppb	N	<0.5	N	<0.5	N	ND	4	4	Discharge from metal refineries And coal-burning factories; discharge from electrical, aerospace, And defense industries	
Cadmium - ppb	N	<0.5	N	<0.5	N	ND	5	5	Erosion of natural deposits, runoff from orchards, runoff from glass & electronics production wastes	
Chromium - ppb	N	<2	N	<2	N	<2	100	100	Discharge from steel and pulp mills; erosion of natural deposits	
Copper - ppm	N	<.002	N	<.002	N	0.016	1.3	AL=1.3	Corrosion of household plumbing systems; erosion of natural deposits; leaching from wood preservatives	
Fluoride - ppm	N	0.79	N	0.74	N	0.68	4	4	Erosion of natural deposits; water additive which promotes strong teeth; discharge from fertilizer and aluminum factories	
Lead - ppb	N	<2	N	<2	N	ND	0	AL=15	Corrosion of household plumbing systems, erosion of natural deposits	
Mercury (inorganic) - ppb	N	<0.5	N	<0.5	N	ND	2	2	Erosion of natural deposits; discharge from refineries and factories; runoff from landfills; runoff from cropland	
Nitrate (as Nitrogen) - ppm	N	2.10	N	2.36	N	1.1	10	10	Runoff from fertilizer use; leaching from septic tanks, sewage; erosion of natural deposits	
Nitrite (as Nitrogen) - ppm	N	<0.01	N	<0.01	N	ND	1	1	Runoff from fertilizer use; leaching from septic tanks, sewage; erosion of natural deposits	
Selenium - ppb	N	<5	N	<5	N	ND	50	50	Discharge from petroleum and metal refineries; erosion of natural deposits; discharge from mines	
Thallium - ppb	N	<1	N	<2	N	ND	0.5	2	Leaching from ore-processing sites; discharge from electronics, glass, and drug factories	
Synthetic Organic Contaminants including Pesticides and Herbicides										
2,4-D - ppb	N	<1.0	N	<1.0	N	ND	70	70	Runoff from herbicide used on row crops	
2,4,5-TP (Silvex) - ppb	N	<1.0	N	<1.0	N	ND	50	50	Residue of banned herbicide	
Alachlor - ppb	N	<0.5	N	<0.5	N	ND	0	2	Runoff from herbicide used on row crops	
Atrazine - ppb	N	<0.5	N	<0.5	N	ND	3	3	Runoff from herbicide used on row crops	
Benzo(a)pyrene - ppb	N	<0.2	N	<0.2	N	ND	0	0.2	Leaching from linings of water storage tanks and distribution lines	
Carbofuran - ppb	N	<0.5	N	<0.5	N	ND	40	40	Leaching of soil fumigant used on rice and alfalfa	
Chlordane - ppb	N	<0.5	N	<0.5	N	ND	0	2	Residue of banned termiticide	
Dalapon - ppb	N	<4.0	N	<4.0	N	ND	200	200	Runoff from herbicide used on rights of way	
Di(2-ethylhexyl) Adipate - ppb	N	<0.5	N	<0.5	N	ND	400	400	Discharge from chemical factories	
Di(2-ethylhexyl) Phthalate - ppb	N	<0.96	N	<0.96	N	ND	0	6	Discharge from rubber and chemical factories	
Dibromochloropropane - ppb	N	<0.02	N	<0.02	N	ND	0	0.2	Runoff/leaching from soil fumigant used on soybeans, cotton, pineapples, and orchards	
Dinoseb - ppb	N	<1.0	N	<1.0	N	ND	7	7	Runoff from herbicide used on soybeans and vegetables	
Endrin - ppb	N	<0.5	N	<0.5	N	ND	2	2	Residue of banned insecticide	
Ethylene dibromide - ppb	N	<0.02	N	<0.02	N	ND	0	0.05	Discharge from petroleum refineries	
Heptachlor - ppb	N	<0.4	N	<0.4	N	ND	0	0.4	Residue of banned termiticide	
Heptachlor epoxide - ppb	N	<0.2	N	<0.2	N	ND	0	0.2	Breakdown of heptachlor	
Hexachlorobenzene - ppb	N	<0.05	N	<0.5	N	ND	0	1	Discharge from metal refineries and agricultural chemical factories	
Hexachlorocyclopentadiene - ppb	N	<0.5	N	<0.5	N	ND	50	50	Discharge from chemical factories	
Lindane - ppb	N	<0.2	N	<0.2	N	ND	0.2	0.2	Runoff/leaching from insecticide used on cattle, lumber, gardens	
Methoxychlor - ppb	N	<0.5	N	<0.5	N	ND	40	40	Runoff/leaching from insecticide used on fruits, vegetables, alfalfa, livestock	
Oxamyl (Vydate) - ppb	N	<2.0	N	<2.0	N	ND	200	200	Runoff from Landfills; discharge of waste chemicals	
Pentachlorophenol - ppb	N	<0.2	N	<0.2	N	ND	0	1	Discharge from wood preserving factories	
Picloram - ppb	N	<1.0	N	<1.0	N	ND	500	500	Herbicide runoff	
Simazine - ppb	N	<0.5	N	<0.5	N	ND	4	4	Herbicide runoff	
Volatile Organic Contaminants										
Benzene - ppb	N	<0.5	N	<0.5	N	ND	0	5	Discharge from factories; leaching from gas storage tanks and landfills	
Carbon tetrachloride - ppb	N	<0.5	N	<0.5	N	ND	0	5	Discharge from chemical plants And other industrial activities	
Chlorobenzene - ppb	N	<0.5	N	<0.5	N	ND	100	100	Discharge from chemical and agricultural chemical factories	
o-Dichlorobenzene - ppb	N	<0.5	N	<0.5	N	ND	600	600	Discharge from industrial chemical factories	
p-Dichlorobenzene - ppb	N	<0.5	N	<0.5	N	ND	75	75	Discharge from industrial chemical factories	
1,2 - Dichloroethane - ppb	N	<0.5	N	<0.5	N	ND	0	5	Discharge from industrial chemical factories	
1,1 - Dichloroethane - ppb	N	<0.5	N	<0.5	N	ND	7	7	Discharge from industrial chemical factories	
cis-1,2 Dichloroethene - ppb	N	<0.5	N	<0.5	N	ND	70	70	Discharge from industrial chemical factories	
trans-1,2 Dichloroethene - ppb	N	<0.5	N	<0.5	N	ND	100	100	Discharge from industrial chemical factories	
Dichloromethane - ppb	N	<0.5	N	<0.5	N	ND	0	5	Discharge from pharmaceutical and chemical factories	
1,2-Dichloropropane - ppb	N	<0.5	N	<0.5	N	ND	0	5	Discharge from industrial chemical factories	
Ethylbenzene - ppb	N	<0.5	N	<0.5	N	ND	700	700	Discharge from petroleum refineries	
Haloacetic Acids, Total - ppb	N	48.0	N	44.0	N	37.3	0	60	By-product of drinking water chlorination	
Styrene - ppb	N	<0.5	N	<0.5	N	ND	100	100	Discharge from rubber and plastic factories; leaching from landfills	
Tetrachloroethylene - ppb	N	<0.5	N	<0.5	N	ND	0	5	Leaching from PVC pipes; discharge from factories and dry cleaners	
1,2,4-Trichlorobenzene - ppb	N	<0.5	N	<0.5	N	ND	70	70	Discharge from textile-finishing factories	
1,1,1 - Trichloroethane - ppb	N	<0.5	N	<0.5	N	ND	200	200	Discharge from metal degreasing sites and other factories	
1,1,2 - Trichloroethane - ppb	N	<0.5	N	<0.5	N	ND	3	5	Discharge from industrial chemical factories	
Trichloroethene - ppb	N	<0.5	N	<0.5	N	ND	0	5	Discharge from metal degreasing sites and other factories	
TTHM - ppb [Total trihalomethanes]	N	42.0	N	45.0	N	61.3	0	80	By-product of drinking water chlorination	
Vinyl Chloride - ppb	N	<0.5	N	<0.5	N	ND	0	2	Leaching from PVC piping; discharge from plastics factories	
Toluene - ppb	N	<0.5	N	<0.5	N	ND	1000	1000	Discharge from petroleum factories	
Xylenes - ppb	N	<0.5	N	<0.5	N	ND	10000	10000	Discharge from petroleum factories; discharge from chemical factories	

HOWARD COUNTY DRINKING WATER QUALITY MONITORING PROGRAM

NAME	WATER QUALITY PARAMETER	APPLICABLE REGULATION	MONITORING PERIOD	SAMPLE LOCATION(S)	MONITORING REPORT DUE DATE	CURRENT MONITORING PERIOD	CURRENT LEVEL DETECTED	MCLG	MCL
Physical Constituents									
Point of Entry Water Quality	pH	Lead & Copper Rule	JUL-DEC; JAN-JUN: permanent	Entry points: Elibank PS, River Rd FH, Rt 40 PS, All Saints PS	January 10 and July 10, each year	Jul-Dec 2014	7.4 - 8.5	NR	
	Alkalinity						30 - 47 ppm	NR	NR
	Calcium						N/A	NR	NR
Distribution Water Quality	pH	Lead & Copper Rule	Quarterly JAN-DEC: 2 samples per site, 1 acid, 1 plain collected at least 2 weeks apart, ideally every 6 months: permanent	10 distribution sites (selected from original 50) + 4 POE (14 sites, 28 bottles)	January 10 and July 10, each year	Jul-Dec 2014	7.3 - 8.6		
	Alkalinity						27 - 41 ppm	NR	NR
	Calcium						16.5 - 23.6 ppm	NR	NR
Inorganic Contaminants									
Lead & Copper	Lead	Lead & Copper Rule	JUN, JUL, AUG, SEP only: due in 2014	50 Tier One homes (selected from prior sample sites if possible)	October 10	June-September 2014 54 Single family customers	90th percentile= 2.2 ppb	0 ppb	AL= 15 ppb
	Copper						90th percentile= 0.100 ppm	1.3 ppm	AL= 1.3 ppm
Microbiological Contaminants									
Bacteriological Quality	pH	SDWA	Monthly JAN-DEC: permanent	150 routine sample sites based on population	10th of each month	Monthly sampling, Nov 2014-Apr 2015	--	NR	
	Chlorine						0.05 to 1.60 ppm	4.0 ppm	4.0 ppm
	Total Coliforms			0 positive			0	Less than 5% of samples	
	Fecal Coliforms			None			0	0	

HOWARD COUNTY DRINKING WATER QUALITY MONITORING PROGRAM

NAME	WATER QUALITY PARAMETER	APPLICABLE REGULATION	MONITORING PERIOD	SAMPLE LOCATION(S)	MONITORING REPORT DUE DATE	CURRENT MONITORING PERIOD	CURRENT LEVEL DETECTED	MCLG	MCL
Volatile Organic Compounds									
Disinfection By-Products	Haloacetic acids (HAA5)	IESWTR	JAN-MAR, APR-JUN, JUL-SEP, OCT-DEC:	End of system for each water supplier's treatment plant	April 10th July 10th October 10th January 10th	Oct-Dec 2014	28 - 54 ppb	0 ppb	60 ppb
Disinfection By-Products	Trihalomethanes (THM)	IESWTR	JAN-DEC:	End of system for each water supplier's treatment plant	April 10th July 10th October 10th January 10th	Oct-Dec 2014	22.4 - 58.8 ppb	0 ppb	80 ppb
Consumer Confidence Reporting Requirements									
Consumer Confidence Report	Consumer Confidence Report	SDWA	JAN-DEC: permanent	Results provided by water suppliers, except Bacteriological and Lead	July 1				
Consumer Confidence Report	Delivery Confirmation Form	SDWA	JAN-DEC: permanent	NA	October 1				

Notes: AL= Action level, MCLG= Maximum Contaminant Level Goal, MCL= Maximum Contaminant Level, ppb= parts per billion, ppm= parts per million, NR= Not Regulated

EXHIBIT 6

**Baltimore County &
Howard County Sewer Agreement**

SEWERAGE AGREEMENT
BETWEEN BALTIMORE COUNTY AND HOWARD COUNTY

MAY 6, 1963

THIS AGREEMENT, made this 6th day of May, 1963, by and between Baltimore County, Maryland, a municipal corporation, hereinafter called "Baltimore County", and the Howard COUNTY METROPOLITAN COMMISSION, hereinafter called "Howard County".

WHEREAS, Howard County proposes to construct a sewerage system in that part of the Patapsco River Drainage Area lying within Howard County and also to construct a sewerage system in that portion of the Little Patuxent Drainage Area upstream from Oakland Mills as shown on a map prepared by Whitman, Raquardt and Associates dated September 28, 1959 and also referred to in a letter dated October 15, 1959 from Bernard L. Werner, Director of Public Works of Baltimore City, to the Chairman of the Howard County Metropolitan Commission; and

WHEREAS, said Baltimore County and Howard County are desirous of entering into an agreement to construct the Patapsco River Interceptor beginning at the confluence of Herbert Run and Patapsco River and running upstream to the confluence of Sucker Branch and said Patapsco River for the purpose of conveying sewage originating in said counties through the said interceptor and thence downstream from said Herbert Run to the facilities of Baltimore City for the eventual disposal thereof;

WHEREAS, the said parties have agreed hereto that the capital cost and other charges and expenses in connection therewith shall be apportioned among them as follows:

NOW, THEREFORE, THIS AGREEMENT WITNESSETH, that in consideration of the premises and mutual benefits accruing to each of the parties hereto, they agree and covenant one with the other as follows:

BALTIMORE COUNTY AGREES:

ITEM 1. To award a contract for the construction of a 54-inch interceptor adjacent to the Patapsco River from the vicinity of the terminus of the existing Patapsco River Interceptor at Herbert Run upstream to a point sufficiently far to permit Howard County to connect its Deep Run Interceptor, which distance is approximately 4,600 feet, and to furnish Howard County with an itemized statement of the cost thereof, which said total cost will be paid one-half by said Howard County and one-half by said Baltimore County. The money is to be paid by said Howard County upon the completion thereof.

ITEM 2. That the said Baltimore County will undertake the construction, as soon as practicable, of the interceptor from its terminus as set forth in the preceding paragraph upstream to the confluence of Oak Forest Branch and the said Patapsco River, said interceptor to be 42 & 48 inch in diameter, and Howard County agrees to pay to said Baltimore County upon the completion thereof that portion of the cost as determined by the ratio of Howard County's 10 mgd capacity to the total capacity of the constructed interceptor.

HOWARD COUNTY AGREES:

ITEM 3. To award a contract for the construction of an interceptor 42 inch in diameter to convey sewage originating in Baltimore County and Howard County from the confluence of Sucker Branch and Patapsco River to a point in Baltimore County approximately 3,500 feet downstream from Ellicott City and to furnish Baltimore County with an itemized statement of the cost thereof which shall be apportioned between said Counties as follows: Howard County's share would be based on the same ratio as set forth in Item 2 above, that is, the ratio 10 mgd bears to the total capacity of the interceptor, and Baltimore County's share shall be the remainder. The money is to be paid by said Baltimore County upon the completion thereof.

ITEM 4. To award a contract for the construction of a temporary sewage treatment plant to be located at the terminus downstream of the interceptor described in the preceding paragraph, and to furnish Baltimore County with an itemized statement of the cost thereof, which said cost should be apportioned at the same ratio as set forth in the preceding paragraph and shall be reimbursed to Howard County upon completion thereof.

ITEM 5. To undertake, at a time mutually agreed upon, the construction of a 42 inch interceptor beginning at the confluence of Oak Forest Branch and the Patapsco River to the said treatment plant referred to in the preceding paragraph, the cost thereof to be apportioned on the same basis as set forth in Item 3 hereof, which said moneys are to be reimbursed to Howard County by said Baltimore County upon completion thereof.

ITEM 6. Howard County agrees to pay Baltimore County the cost of operation and maintenance of the said Patapsco River Interceptor and pumping facilities in said Baltimore County and to reimburse Baltimore County for the operation and maintenance costs of Baltimore City's system, said reimbursement to be at the same rate that Baltimore County pays to Baltimore City. The amount of Howard County's share of said cost will be determined by the volume of sewage flowing through the various metering devices located in Howard County at the points of discharge of Howard County interceptors into the said Patapsco Interceptor.

ITEM 7. To reimburse Baltimore County for the operation and maintenance of said temporary sewage treatment plant located as above. Reimbursement to Baltimore County will be based upon the ratio of the actual sewage flows as measured by the metering device located in Howard County at the points of discharge of Howard County's Sucker Branch Interceptor and Tiber Branch Interceptor into the said Patapsco Interceptor to the total flow in the said Patapsco Interceptor into the temporary sewage treatment plant.

ITEM 8. It is mutually understood and agreed by the parties hereto that Howard County's capacity in the permanent facilities above mentioned upstream from the connection of the Deep Run Interceptor with the said Patapsco River Interceptor is an average daily flow of 5.0 mgd and a peak flow of 10.0 mgd. It is also mutually understood and agreed by the parties hereto that Howard County's flow downstream from the said Deep Run Interceptor will be an estimated 10.0 mgd average daily flow and 20.0 peak flow and that the interceptors, pumping stations and treatment facilities at both Baltimore County and Baltimore City will provide these capacities for Howard County.

ITEM 9. At such time as Howard County transmits a volume of sewage through the Patapsco Pumping Station and Force Main system owned and operated by Baltimore County, Howard County will be responsible for debt service charges on the jointly used system. The appropriate debt service charge shall apply to the unamortized cost of the facilities and shall be computed by the ratio which the annual sewage flow from Howard County bears to the total annual sewage flow through the jointly used facility.

ITEM 10. Whenever it shall be necessary to enlarge existing facilities, construct or install any addition to the sewerage system under the supervision of Baltimore County or Baltimore City, which receive, transmit, pump, treat and/or dispose of sewage from Howard County, debt service will be payable to Baltimore County in the same ratio that the designed ultimate capacity allotted to Howard County bears to the total designed ultimate capacity allotted to serve all the parties through the jointly used facility.

IN WITNESS WHEREOF, the parties hereto have properly executed this Agreement, as of the day, month and year first above written.

ATTEST:

s/William A. Badger

s/Albert B. Kaltenbach
ALBERT B. KALTENBACH
Director, Department of Public Works

ATTEST:

s/Ormsby S. Moore

By: s/Spiro T. Agnew
SPIRO T. AGNEW
County Executive

BALTIMORE COUNTY, MARYLAND

Approved as to Form and Legal Sufficiency
this 3rd day of May, 1963:

s/Harry S. Shapiro
Asst. County Solicitor

ATTEST:

s/Evelyn G. Meyer

By: s/Roger M. Laynor
Chairman

s/LaRoy C. Moser
Member

Approved as to Form and Legal Sufficiency
this 14th day of February, 1963:

s/
Counsel for the Commission

s/J.C. Jenkins
Member

s/David W. Force
County Commissioner Member

HOWARD COUNTY METROPOLITAN COMMISSION

MODIFICATION OF JUNE 6, 1963 AGREEMENT

FEBRUARY 28, 1964

THIS MODIFICATION OF AGREEMENT is made this 28th day of February, 1964 by and between BALTIMORE COUNTY, MARYLAND, a municipal corporation, hereinafter called "Baltimore County", and the HOWARD COUNTY METROPOLITAN COMMISSION, hereinafter called "Howard County", to facilitate the early construction of the Patapsco River Interceptor as outlined in Item 1 of the Agreement dated 6th day of May, 1963 by and between Baltimore County and Howard County.

MODIFICATION OF ITEM 1: To allow Howard County, subject to Baltimore County approval, to award the contract for the construction of the 34-inch interceptor adjacent to the Patapsco River from the vicinity of the terminus of the existing Patapsco River Interceptor at Herbert Run upstream to a point sufficiently far to permit Howard County to connect its Deep Run Interceptor, which distance is approximately 4,600 feet. The total cost of the interceptor will be paid one-half by said Howard County and one-half by said Baltimore County. Baltimore County will pay said Howard County during the period of construction of the interceptor said Baltimore County's share of the cost upon receipt of monthly requisitions from said Howard County.

ATTEST:

s/Edgar J. DeHoss

s/Albert B. Kaltenbach
ALBERT B. KALTENBACH
Director, Department of Public Works

s/ Ormsby S. Moore

By: s/Spiro T. Agnew
SPIRO T. AGNEW
County Executive
Baltimore County, Maryland

Approved as to Form and Legal Sufficiency
this 27th day of February, 1964:

APPROVED
BALTIMORE COUNTY EXECUTIVE BOARD

s/ Harry S. Shapiro
Asst. County Solicitor

FEB 18 1964 s/

ATTEST:
s/Evelyn G. Meyer

HOWARD COUNTY METROPOLITAN COMMISSION
By: s/Roger N. Laynor
Chairman

Approved as to Form and Legal Sufficiency
this 22nd day of February, 1964

s/
Member

s/Robert E. Wieder
Counsel for the Commission

s/

APPROVED
BALTIMORE COUNTY EXECUTIVE BOARD
FEB 18 1964

SEWERAGE AGREEMENT
BETWEEN BALTIMORE COUNTY AND HOWARD COUNTY

AUGUST 2, 1968

THIS AGREEMENT, made this second day of August, 1968, by and between Baltimore County, Maryland, a municipal corporation, hereinafter called "Baltimore County", and the Howard COUNTY METROPOLITAN COMMISSION, a body corporate and politic, hereinafter called "Howard County", revises the Agreement made May 6, 1963, and subsequent modification there-to dated February 28, 1964, with the exception of work that was completed prior to the date of this Agreement.

WHEREAS, Howard County proposes to construct a sewerage system in that part of the Patapsco River Drainage Area lying within Howard County and also to construct a sewerage system in that portion of the Little Patuxent Drainage Area upstream from Oakland Mills as shown on a map prepared by Whitman, Reardon and Associates dated September 28, 1959 and also referred to in a letter dated October 15, 1959 from Bernard L. Werner, Director of Public Works of Baltimore City, to the Chairman of the Howard County Metropolitan Commission; and

WHEREAS, said Baltimore County and Howard County are desirous of entering into an agreement to construct the Patapsco River Interceptor beginning at the confluence of Herbert Run and Patapsco River and running upstream to the confluence of Sucker Branch and said Patapsco River for the purpose of conveying sewage originating in said counties through the said interceptor and thence downstream from said Herbert Run to the facilities of Baltimore City for the eventual disposal thereof;

WHEREAS, Howard County is the applicant for all State and Federal grants available to both parties hereto for the said interceptor and said parties agree to share said State and Federal grants determined by the ratio of the design capacity for each county to the total design capacity for both counties. In each contract Baltimore County and Howard County will initially provide sufficient local funds to cover the cost of the entire project in proportion to their ultimate responsibilities. As grants are received by Howard County, Howard County will remit to Baltimore County the Baltimore County share of the grants.

NOW, THEREFORE, THIS AGREEMENT WITNESSETH, that in consideration of the premises and mutual benefits accruing to each of the parties hereto, they agree to and covenant one with the other as follows:

ITEM 1. Howard County agrees to solicit bids for and award the contract for the construction of the interceptor from its present terminus approximately 200 feet north of Deep Creek upstream to the confluence of Oak Forest Branch and the said Patapsco River; said interceptor to be 48-inches and 54-inches in diameter. Administrative, legal and engineering services for the design and construction of this portion of the interceptor will be furnished to Howard County by Baltimore County. The cost to be pro-rated in accordance with the designed capacities as set forth below:

- a) Oak Forest Branch to Dairy Branch (Santee Branch) the design capacity for Howard County is 12.0 mgd and for Baltimore County 27.6 mgd.
- b) Dairy Branch (Santee Branch) to Bull Branch, the design capacity for Howard County is 12.0 mgd and 29.4 mgd for Baltimore County.
- c) Bull Branch to Stillhouse Run, the design capacity for Howard County is 13.0 mgd and for Baltimore County 30.8 mgd.
- d) Stillhouse Run to a point approximately 200' north of Deep Creek the design capacity for Howard County is 13.0 mgd and for Baltimore County 31.5 mgd.

ITEM 2. Howard County agrees to undertake at a time mutually agreed upon the construction of a 42-inch interceptor beginning at the confluence of Oak Forest Branch and Patapsco River and extending to the temporary treatment plant located approximately 3,000 feet south of the Tiber Branch. The total cost shall be apportioned in accordance with the design capacities noted below:

- a) From the treatment plant to Thistle Branch, the design capacity for Howard County is 12.0 mgd and for Baltimore County 25.9 mgd.
- b) Thistle Branch to Oak Forest Branch, the design capacity for Howard County is 12.0 mgd and for Baltimore County 26.0 mgd.

ITEM 3. Howard County agrees to pay Baltimore County upon invoicing the cost of operation and maintenance of the said Patapsco River Interceptor and pumping facilities in said Baltimore County and to reimburse Baltimore County for the operation and maintenance costs of Baltimore City's system, said reimbursement to be at the same rate as that in effect at the time Baltimore City bills Baltimore County. The amount of Howard County's share of above said costs will be determined by the volume of sewage flowing through the various metering devices located in Howard County at the points of discharge of Howard County interceptors into the said Patapsco Interceptor.

ITEM 4. It is mutually understood and agreed by the parties hereto that Howard County's previously set forth capacities in the permanent facilities above mentioned upstream from the connection with the Deep Run Interceptor with the said Patapsco River Interceptor shall be provided for in the interceptors, pumping stations and treatment facilities of both Baltimore County and Baltimore City.

ITEM 5. At such time as Howard County transmits a volume of sewage through the existing Patapsco Pumping Station and Force Main system owned and operated by Baltimore County, Howard County will be responsible for debt service charges on the jointly used system. The appropriate debt service charge shall apply to the unamortized cost of the facilities and shall be computed by the ratio which the annual sewage flow from Howard County bears to the total annual sewage flow through the jointly used facility.

ITEM 6. Whenever it shall be necessary to enlarge existing facilities, construct or install any addition to the sewerage system under the supervision of Baltimore County or Baltimore City, which receive, transmit, pump, treat and/or dispose of sewage from Howard County, debt service will be payable to Baltimore County in the same ratio that the designed ultimate capacity allotted to Howard County bears to the total designed ultimate capacity allotted to serve all the parties through the jointly used facility.

IN WITNESS WHEREOF, the parties hereto have properly executed this Agreement as of the day, month and year first above written.

ATTEST:

s/Thornton M. Mouring

s/Albert B. Kaitenbach
ALBERT B. KALTENBACH
Director, Department of Public Works

ATTEST:

s/Edward J. Jones

BALTIMORE COUNTY, MARYLAND

s/William Fornoff 8-2-68
for DALE ANDERSON, County Executive

Approved as to Form and Legal Sufficiency
this 31st day of July, 1968

s/
County Solicitor

ATTEST:

HOWARD COUNTY METROPOLITAN COMMISSION

s/
Acting Secretary-Treasurer

s/J. Calvin Voris
J. CALVIN VORIS, Chairman

Approved as to Form and Legal Sufficiency
this 23rd day of July, 1968

s/
Member

s/Robert E. Wieder
Counsel for the Commission

s/

BOARD OF COUNTY COMMISSIONERS OF
HOWARD COUNTY

s/Harry T. Murphy
Chairman

s/
Member

s/
Member

SEWERAGE AGREEMENT
BALTIMORE COUNTY AND HOWARD COUNTY

JUNE 4, 1979

THIS AGREEMENT, made this 4th day of June, 1979, by and between BALTIMORE COUNTY, MARYLAND, hereinafter referred to as the FIRST PARTY, and HOWARD COUNTY, MARYLAND, hereinafter referred to as the SECOND PARTY, each of said Parties a body corporate and politic of the State of Maryland.

WHEREAS, the First and Second Parties entered into agreements dated May 6, 1963 and August 2, 1968 providing for discharge of sewage from certain sewerage systems of Second Party into certain sewerage systems of the First Party; and

WHEREAS, the First Party has entered into agreements with Baltimore City for the disposal of sewage; and

WHEREAS, there have been substantial increases in population, volume of sewage, operation and maintenance costs, and costs of construction of jointly-used facilities since the agreements were executed on May 6, 1963 and August 2, 1968, and the Parties thereto desire to update said Agreements; and

WHEREAS, it is the intent of the parties hereto that the sewerage system of the First Party shall continue to receive sewage from the Second Party and that a method for the computation and payment of costs incurred by the First Party for construction of jointly-used facilities and for collection, transmission and disposal of sewage from the Second Party be established:

NOW, THEREFORE, THIS AGREEMENT WITNESSETH:

THAT IN CONSIDERATION of the covenants, agreements and payments hereinafter set forth, it is mutually covenanted and agreed as follows:

ARTICLE I, DEFINITIONS

A. "Capital Expenditure" is hereby defined as the net costs involved in the construction and/or installation of any sewerage facility and shall include, but not be limited to, the sum of the following items; Land and/or easements, consultants' fees, material, labor, utility relocations, overhead which may include a proportionate allocation of in-house costs associated with design, field engineering, surveys, borings, materials testing, maps and record maintenance, inspection, right-of-way expenses, advertising, administrative, clerical, and stenographic services, office space use and building operation and maintenance; and all other contributing costs or expenses. Capital expenditures shall be exclusive of grants from the Federal Government, the State of Maryland, or any capital contributions by others than the parties to this Agreement. For the purposes of this Agreement, capital expenditure shall also mean any cash contribution by the First Party to Baltimore City for the construction and/or improvement of a City-owned jointly-used facility.

B. "City" is hereby defined as the City of Baltimore, Maryland.

C. "Debt Service" is hereby defined as the sum of interest and principle for a specific capital expenditure.

D. "Design Flow Method" is a method of cost allocation determined from a tabulation of the projected volume of sewage to be contributed by each party to this Agreement that was used to design the proposed jointly-used facility. Ratios of cost responsibility of

additional facilities, including the addition of secondary and advanced waste treatment, are developed by dividing capacity allocated to each party having a beneficial interest by the projected total designed capacity allocated to all beneficially interested. Ratios of cost responsibility for the expansion of existing facilities are developed by dividing the increase in flow projected for each beneficially interested party to the design year by the total increase in flow projected to the design year for all beneficially interested parties.

E. "Director" shall mean the Director of Public Works of either the First or Second Parties, or their duly authorized representatives or agents.

F. "Facility" for the purpose of this Agreement shall mean any installation, including real and personal property, that is used or useful for the purpose of receiving, transmitting, pumping, treating and/or disposing of sewage or sludge.

G. "Jointly-used Facility" is hereby defined as any facility that receives, transmits, pumps, treats, and/or disposes of the sewage from both parties to this Agreement.

H. "Major Repair and/or Rehabilitation" is hereby defined as any restoration of a facility which does not increase the capacity of the facility and which is not considered a routine maintenance item.

J. "Sanitary Sewer" is a pipe or conduit, the specific purpose of which is to carry waste water as defined below.

K. "Purchase Design Capacity" of a jointly-used facility is hereby defined as that portion of the total design capacity of a jointly-used facility that the principal payments of either or both parties bear to the total capital expenditures for construction, improvements, and/or installation of said facility.

L. "Waste Water or Sewage" consists of the water-carried waste discharged from the dwellings, governmental and commercial business buildings, institutions and industrial establishments, together with industrial wastes, surface and sub-surface waters and storm waters which may be present.

M. "Storm Water" is excess water running off from the surface of a drainage area during and immediately following rainfall, snowfall, or other meteorological precipitation.

N. "Storm Drain" is a drain through which storm water, storm run-off, condensate, cooling water, street wash and other wash waters or drainage flow and from which waste water is excluded.

O. "Subsurface Water" is water that occurs in the lithosphere. It comprises suspended water and ground water.

P. "Surface Water" is water that rests on or flows over the surface of the lithosphere.

Q. "Volumetric Method" is a method determined by an annual calculation of the volume of sewage contributed by each party to this Agreement to each jointly-used facility. Ratios of cost responsibility are developed by dividing the volume of sewage contributed by each Party to this Agreement to the total volume of sewage that is received, transmitted, pumped, treated and/or disposed of by each jointly-used facility.

R. "Constructed and/or improved" is hereby defined as any construction or improvement, which increases the designed capacity of the facility.

ARTICLE II. RIGHTS OF EITHER PARTY NOT TO BE ABROGATED

A. Nothing in this Agreement shall limit or abrogate any right or rights delegated to either Party by Acts of the General Assembly of the State of Maryland.

B. It is further understood and agreed that the police, legislative and governmental power of either Party are in no sense attempted to be abridged or restricted by this Agreement.

C. Each Party hereto agrees to recognize all rights and privileges acquired by acquisition of property and/or rights-of-way, each from the other and/or from other parties.

ARTICLE III. RIGHT OF REVIEW

The Second Party shall, upon request, have the right to review reports, plans, bids and financing for major repairs and/or rehabilitation and construction and/or improvement of any jointly-used facility owned or operated by the First Party.

Any costs associated with said review shall be borne exclusively by the reviewing party.

Nothing in this Agreement shall limit or abrogate any right or rights of either Party to enter into other separate agreements for the planning, designing and constructing of sewerage facilities, one with the other or with other parties, providing such separate agreements do not conflict with or serve to negate prior agreements made between the two parties to this agreement.

ARTICLE IV. LIMITATION OF TERRITORY

This Agreement applies only to that portion of Howard County which is served or will be served by the Baltimore County Patapsco Pumping Station.

ARTICLE V. CONNECTIONS TO SEWERAGE SYSTEM

A. The sanitary sewers of the Second Party shall be connected with the jointly-used facilities of the First Party only at such points and as may be agreed to in writing.

B. The Second Party shall notify the First Party in writing at least five (5) days before making any connection to the jointly-used facilities of the First Party so as to allow the inspection of construction of said connections at the site of said work.

C. At no time may the First or Second Party's use of a jointly-used facility exceed their respective purchased design capacity, as between the parties hereto, of said facility without the expressed written permission of the other Party.

D. The Second Party's Director shall transmit to the First Party's Director, not later than November 1 of each year, projections of flows from the Second Party to the First Party by point of entry. Based upon said projections, the respective Directors shall prepare a Six Year Capital Improvement Program designed to accommodate the projected flows in the jointly-used facilities. The Director of the First Party shall transmit to the Director of the Second Party, by November 1 of each year, a listing of expected major repairs and/or rehabilitations and respective Directors shall prepare a schedule of such work and include their respective cost sharing in the adopted Fiscal Budget.

E. Upon approval of the annual budget, the Directors shall notify their counterparts of those system facilities that have been included in the officially adopted Capital Improvement Program and shall also provide data by years on flows to be accommodated at each point of entry and capacities to be made available for the Second Party's flows, all

predicated upon the completion of such improvements. Each such annual notification will be deemed to supersede all prior such notifications and shall be binding for the ensuing period.

F. At least bi-monthly the Second Party shall forward to the Director of the First Party, a listing of allowed individual connections which admit flows into the sewerage system of the First Party. The list shall include connection locations and anticipated average and peak flows along with any seasonal variations.

G. The parties to this Agreement do hereby acknowledge the statutory responsibility of the State Department of Health and Mental Hygiene in reference to the adequacy of the jointly-used facilities and agree to submit any disputes concerning the physical aspects of the facilities to said Department for adjudication.

ARTICLE VI. STORM WATER, SURFACE WATER AND
OTHER MATERIALS NOT TO BE DISCHARGED
INTO SANITARY SEWERS

A. Storm water, surface water, subsurface water and other nonpolluted wastes shall not be discharged into those sanitary sewers which drain into the jointly-used facilities of the First Party. No street inlet, catch basin, storm drain, rain leader, cellar drain, garage drain, or any other connection through which storm water, surface water, ground water or any other water not classified as waste waters can flow, shall be connected to the aforesaid sanitary sewers which drain into the jointly-used facilities of the First Party.

B. The Second Party agrees to use every effort to prevent the owners of properties in Howard County from discharging storm water into the sanitary sewers connecting with the sanitary sewers of the First Party, and if any such connections are detected, the Director of the Second Party shall require that such connections, including storm inlets and other points of entry, are otherwise diverted or abandoned and sealed.

C. No person, firm, corporation, manufacturing plant, or other establishment, shall be permitted to discharge into any sanitary sewer of the Second Party, which drains into a sanitary sewer of the First Party, any flammable liquids, acids, chemicals and/or materials or solids not normally present in domestic sewage, which, in the judgment of the Directors of the Parties hereto, jointly or severally, may be detrimental to the sewerage system, or any part thereof, of the First Party or the operation thereof. The Second Party agrees that its Industrial Waste Ordinances shall conform to at least the minimum provisions of the First Party's Industrial Waste Ordinances, as such provisions apply to waste waters flowing from the Second Party's system into the First Party's system.

D. The discharge of radioactive wastes into any of the sanitary sewers of the Second Party shall be limited as to quantity and character in accordance with the latest rules and regulations of the State Department of Health and Mental Hygiene, Deputy State or County Health Officer of Howard County, and the Deputy State or County Health Officer of Baltimore County, Maryland, whichever of these rules and regulations are most stringent.

ARTICLE VII. CONSTRUCTION OF SANITARY SEWERS

All sanitary sewers, house sewers, interceptors, manholes, bell-mouths and connections between the sanitary sewers of both Parties shall be designed and constructed in accordance with the applicable codes, rules and regulations of the party within whose boundaries the construction is located.

ARTICLE VIII. INSPECTION OF PREMISES

The premises of the properties in the territory defined in Article IV, which drain into sewers of the First Party, may be entered with previous written notice and inspected jointly

by the Directors or their representatives. Private premises are excluded from the foregoing stipulations and may be entered only after proper authorization has been secured.

ARTICLE IX. REPAIRS AND REHABILITATIONS

A. Whenever it becomes necessary for the First Party to make major repairs and/or rehabilitations to any part of any jointly-used facility which receives, transmits, pumps, treats and/or disposes of sewage, the Second Party shall contribute its proportionate share of all costs resulting from the planning, designing and construction of the said repair and/or rehabilitation, including all materials, labor, engineering and any and all other costs involved therein. The cost of items referred to in this Article shall be apportioned according to the Volumetric Method using the quantities of sewage contributed by both parties to this Agreement, for the fiscal year preceding that in which the costs were incurred.

B. Payment by the Second Party to the First Party for repairs and/or rehabilitations covered by this Article shall be made as the work progresses. Such payment, billed each month for the proportionate share of payment for the work completed, shall be due within 30 days of the rendering of such bill.

C. Upon agreement between both parties to this Agreement, expenditures for repairs and/or rehabilitation to jointly-used facilities may be considered capital expenditures, if paid from bond money, the repayment for which to be made by the Second Party to the First Party, shall be included in the annual debt service charge as calculated by the Volumetric Method.

ARTICLE X. FINANCING OF ADDITIONAL FACILITIES

A. The capital expenditures for jointly-used sewerage facilities constructed and/or improved after June 30, 1969, except as hereinafter provided, shall be apportioned to each party to this Agreement by the Design Flow Method.

Payment by the Second Party to the First Party for the Second Party's share of improvements to City-owned jointly-used facilities for which the First Party will have paid the City the Second Party's share, will be based on the Design Flow Method. In this case, the share of the Second Party's cost responsibility shall be developed by dividing the design capacity to be contributed by the Second Party by the sum of the design capacities to the jointly-used facility, exclusive of Baltimore City's projected flow. To calculate the Second party's financial responsibility multiply its share as calculated above by the First Party's payment to the City.

Payment by the Second Party to the First Party for the Second Party's share of improvements to jointly-used facilities owned by the First Party will be based on the Design Flow Method. In this case, the share of the Second Party's cost responsibility shall be developed by dividing the design capacity to be contributed by the Second Party by the sum of the design capacities to the jointly-used facility. To calculate the Second Party's financial responsibility, multiply its share as calculated above by the First Party's capital expenditures associated with the improvements.

B. Before the First Party commences construction or installation of any additional sewerage facilities or improvements to existing sewerage facilities that may be jointly-used by the parties to this Agreement, the Second Party shall certify that funds for its share of participation are available. In the event that funds are not available, the Second Party agrees to attempt to obtain funds as quickly as possible or to make other mutually agreeable arrangements for payments.

C. Payment to the First Party by the Second Party shall be made as the work progresses. Such payment, billed each month for the proportionate share of payment for work completed, shall be due within 30 days of the rendering of such bill.

D. Upon agreement between both parties of this Agreement, any capital expenditure for a jointly-used facility may be entirely funded with the bond money of the First Party, and repayment by the Second Party to the First Party shall be included in the annual debt service charge as calculated in Article XII, paragraph B.b. of this Agreement.

E. Whenever both Parties agree to increase either Party's purchased design capacity, as between the Parties hereto, of a jointly-used facility, as stipulated in Article V, the financial responsibility for the construction, improvements, and/or installation of said facility shall be adjusted accordingly. The Party liable for the adjustment shall remit the owing amount to the other Party in a lump-sum cash payment no later than sixty (60) days after notice of said adjustment.

ARTICLE XI. DETERMINATION OF SEWAGE FLOW

A. In order to measure and record automatically the volume of sewage flowing from the sewerage system of the Second Party into the sewerage system of the First Party, recording and registering flow meters, satisfactory to and approved by the Directors of both Parties, shall be constructed, installed, and ready for regular continuous service at or near points of entry of sewage from the Second Party to the sewerage system of the First Party within one year from the date of this Agreement. The cost of said meters, their installation, and their operation and maintenance shall be borne entirely by the Second Party.

B. In the event of failure of meters installed per paragraph A above, the Second Party agrees to proceed with repairs within 60 days or to order replacements within 60 days.

C. If the Second Party cannot demonstrate progress towards replacing or repairing meters is being made within 60 days, as outlined in paragraphs A and B above, the First Party may cause said installation and/or repairs, including design, purchase of equipment and materials, labor, and entrance by the First Party unto the premises of the Second Party. The Second Party shall be liable for all of the above referred to costs and expenses incurred by the First Party for the installation and/or repairs referred to in this paragraph.

D. At least once monthly, the Second Party shall forward to the First Party the actual meter readings and recordings for each identified meter at each point of entry. By August 15 of each year, the Second Party shall also forward to the First Party an annual summary of meter readings and flows at each point of entry for the preceding fiscal year and reconciliations for any differences between the annual figures and the cumulative monthly figure.

E. In the event of meter failure, replacement, and/or repairs, where the sewage flow has been accurately metered for a minimum of 200 days in any twelve-month period, then the daily flows for the entire year shall be considered to be the same as the average daily flow of that period of the year that has been metered. In the event meter failure, replacement, and/or repairs where the sewage flow has been accurately metered for less than 200 days, then the sewage flow will be determined by a method mutually agreed upon by the two parties.

F. Until flow meters are installed, as stipulated in Paragraph A above, the calculation of the total annual sewage flow from the sewerage system of the Second Party to the sewerage system of the First Party shall be based on 100% of the metered water consumption of the contributing areas of the Second Party or on any other method mutually considered to be a more accurate representation of actual sewage flows.

ARTICLE XII. DETERMINATION OF SEWERAGE SERVICE CHARGES

The calculations for charging the Second Party for sewerage services rendered by the First Party shall be composed of a sewerage service charge for the Second Party's share of operation and maintenance expenses of jointly-used facilities and an annual charge for debt

service for the Second Party's share of the debt service of the First Party as applied to the jointly used facilities.

The Second Party shall pay to the First Party annually a Sewerage Service Charge representing the Second Party's share of direct costs incurred by the First Party for transporting, pumping, treating and/or disposing of sewage during the preceding fiscal year. The aforementioned direct costs shall include all the operating and maintenance costs for jointly-used facilities, reduced by the amount of direct costs recovered as surcharges under the Industrial Waste Ordinance. Direct costs shall include all payroll expenses (i.e. payroll, pensions, FICA payments, Workmen's Compensation payments, leave with pay and fringe benefits), rentals, contractual services, supplies, materials, equipment expenses (i.e. maintenance and minor repairs), utilities, and other expenses, as well as other indirect Bureau expenses properly chargeable.

The Second Party shall also pay to the First Party that amount of surcharge collected from industry for reason of excessive Biological Oxygen Demand, suspended solids, or other constituents above that limit established by law of the First Party or as may be amended from time to time, as that permitted without payment of a surcharge. Such surcharge shall be in accordance with the charges established by the First Party.

If at any time a jointly-used facility is no longer used by the Second Party, the Second Party will no longer be charged for the use of the facility from the time of non-use but will be responsible for the previous period of use.

All sewerage service charges shall be computed as follows:

A. Computation of annual Operation and Maintenance Costs.

a. Determine the First Party's costs for:

1. Operation and maintenance of Patapsco Pump Station.
2. Operation and maintenance of jointly-used sewers.
3. Six percent (6%) of the sum of (1) and (2) above, which represents other indirect Bureau charges relating to sewerage services.
4. Divide the total annual sewage flow contributed by the Second Party to the Patapsco Pump Station (as stipulated in Article XI) by the total annual metered flow through the Patapsco Pump Station to obtain a factor expressed as a percentage appropriately adjusted for outages and overflows. Multiply the sum of 1, 2, and 3 above by the percentage factor so derived, to obtain the Second Party's proportionate share in the operation and maintenance of Patapsco Pump Station and jointly-used sewers.

- b. Divide the total annual sewage flow contributed by the Second Party (as stipulated in Article XI) by the total annual sewage flow contributed by Anne Arundel County, Baltimore County, and Howard County, to the City's Patapsco Waste Water Treatment Plant through the Patapsco Pump Station to obtain a factor expressed as a percentage appropriately adjusted for outages and overflows. Multiply the amount that the First Party paid the City for treatment and disposal of sewage at the City's Patapsco Waste Water Treatment Plant by the percentage factor so derived, to obtain the Second Party's proportionate share in the treatment and disposal of sewage at the City Plant.

- c. The sum of the costs derived in a and b above represents the Second Party's proportionate share in the First Party's operation and maintenance costs.

B. Computation of Debt Service

- a. The Second Party's annual share of debt service resulting from bonds issued by the First Party for improvements to jointly-used facilities completed before June 30, 1969, except as hereinafter provided, shall be based on the Volumetric Method and shall be calculated as follows:

1. Construction and Improvements to Patapsco Pump Station and Force Main.

Divide the total annual sewage flow contributed by the Second Party to the Patapsco Pumping Station (as stipulated in Article XI) by the total annual metered flow through the Patapsco Pumping Station to obtain a factor expressed as a percentage appropriately adjusted for outages and overflows. To obtain the Second Party's proportionate share in the First Party's annual debt service for the pumping station and force main, multiply the factor so obtained above by the product of the quotient of \$795,000.00 (the cost of said facilities) and \$5,000,000.00 (proceeds of the Baltimore County Metropolitan District 17th Serial Bond Issue) and the First Party's annual debt service for the unamortized amount of the Baltimore County Metropolitan District 17th Serial Bond Issue. These payments by the Second Party shall continue until the facilities are abandoned or until the 17th Serial Bond Issue is fully amortized. To calculate the Second Party's share in the First Party's imputed annual debt service for the installation of an additional pump at the Patapsco Pumping Station, divide the total annual sewage flow contributed by the Second Party to the Patapsco Pumping Station (as stipulated in Article XI) by the total annual metered flow through the Patapsco Pumping Station to obtain a factor expressed as a percentage appropriately adjusted for outages and overflows; then multiply factor so obtained by \$19,588.00. Such annual share of debt service shall be calculated for four (4) years.

2. Two Additional Primary Settling Tanks at the City's Patapsco Waste Water Treatment Plant.

Divide the total annual sewage flow contributed by the Second Party to the Patapsco Pump Station (as stipulated in Article XI) by the total annual sewage flow contributed by the First Party to the City's Patapsco Waste Water Treatment Plant to obtain a factor expressed as a percentage appropriately adjusted for outages and overflows. Multiply the First Party's annual debt service for their cash contribution for Primary Settling Tanks 5 and 6 at the City's Patapsco Waste Water Treatment Plant by the factor so derived, to obtain the Second Party's proportionate share for the additional tanks. Both Parties agree that the First Party's annual debt service for its cash contribution for the Primary Settling Tanks is \$1,890.00 for 30 years.

3. Patapsco Interceptor (from Herbert Run downstream to Patapsco Pump Station)

The Second Party shall, annually and for forty (40) years from the date of this Agreement, pay the First Party the sum of Two Thousand and One Hundred and Fifty dollars (\$2,150.00) which represents the Second Party's share of the First Party's annual debt service for the construction of the Patapsco Interceptor from Herbert Run downstream to the Patapsco Pumping Station. This amount is based upon the First Party's annual debt service of \$36,660 and the Second Party's design flow allocation of 5.86% of the total ultimate design flow of the Interceptor.

4. The sum of the costs derived in 1, 2 and 3 above represents the Second Party's proportionate share in the First Party's debt service for improvements to jointly used facilities.

- b. If both parties agree that repayment by the Second Party to the First Party for a capital expenditure for a jointly used facility made after June 30, 1969 shall be included in the annual debt service charge, as stipulated in Article X, paragraph D, of this Agreement, the Second Party shall pay debt service on their share of the capital expenditure as determined by the Design Flow Method.

C. The sum of the costs derived in A and B above shall constitute the Second Party's annual obligation for sewerage services provided by the First Party.

ARTICLE XIII. CHARGES TO BE RECALCULATED ANNUALLY

A. The Second Party shall, by August 15 of each year, submit in writing to the First Party the readings of all sewage flow meters at points of entry to the First Party's sewerage system as stipulated in Article XI. The report submitting the meter readings and flows shall specify such locations and points of entry into the sewerage system as herein provided.

B. On or before the 15th day of January of each year, the Director of the First Party shall submit to the Director of the Second Party a statement showing computations of the Second Party's share of costs for the preceding fiscal year. The statement and computations shall be jointly prepared by both parties and shall show the net total of the various sums by the Second Party to the First Party arrived at by the methods outlined in Article XII. Said sums, so due and owing by the Second Party to the First Party, shall be payable within sixty (60) days after the date of submittal of the statements.

ARTICLE XIV. ACCESS TO RECORDS

Each party to this Agreement shall have ready access to all plans, office and field records, costs accounts, records and files for jointly used sanitary sewerage facilities and installations of the other party.

Either party shall have ready access to all design data, schedules, programs and costs estimates relating to altering or enlarging the jointly used sanitary sewerage system, or any part thereof, that serves or will serve both parties.

Each party shall have ready access to all information, records, calculations and data used to determine the total annual charge for sewerage service.

Each party shall have the right to audit the other Party's statements and accounts useful and/or necessary to the performance of this Agreement. Such audits shall be made at the auditing party's expense.

ARTICLE XV. OPERATION AND MAINTENANCE OF FACILITIES

It is agreed by both parties that each party shall supervise the operation and maintenance of the various facilities of their respective sewerage systems.

ARTICLE XVI. PATAPSCO SEWERAGE PUMPING STATION AND FORCE MAIN IMPROVEMENTS

The Second Party recognizes the benefits it will receive from the replacement of and improvement to the First Party's Patapsco Sewage Pumping Station and Force Main to be partially financed under Environmental Protection Agency's Grant No. C-240470010. Pursuant to P. L. 92-500, the Second Party recognizes the following obligations and agrees to the following provisions:

A. The Second Party agrees to limit its peak flow at any one time to 17.8 mgd during the service life of the initial pumping facilities. The initial pumping facilities are designed for a peak flow of 45 mgd to be allocated as follows:

Baltimore County	20.7 mgd
Howard County	17.8 mgd
Anne Arundel County	6.5 mgd

The Second Party agrees to fund 39.6% of the local costs associated with the improvements included within the scope of EPA Grant No. C240470010. This percentage is based upon the Design Flow Method of financing new facilities.

B. The Second Party agrees to levy a sewer user charge on each of its customers whose wastewaters flow into the First Party's Patapsco Sewerage System. Said user charge shall be designed to assure that each customer will pay its proportionate share of the Second Party's share of the First Party's cost of operation and maintenance (including replacement) of all waste treatment services provided by the First Party.

The Second Party further agrees to levy an extra-strength surcharge on each of its customers in accordance with Baltimore County's Sewer Ordinance (Bill No. 135-76). All revenue collected therefrom by reason of Baltimore County's costs in transporting and treating said extra-strength sewage shall be remitted to the First Party.

C. The Second Party agrees to enforce all the provisions of Baltimore County's Sewer Ordinance (Bill No. 135-76) as they apply to customers under the Second Party's jurisdiction.

The Second Party further agrees to report to the First Party the introduction of toxic, incompatible, or significant industrial wastes at least six (6) months prior to their acceptance into the sewerage system.

D. The Second Party agrees to develop and maintain an Industrial Cost Recovery System applicable to Grant No. C-240470010 which shall require all present and future industrial users to pay that portion of the grant amount allocable to the treatment of wastes from such users in conformance with all applicable Federal requirements.

ARTICLE XVII. ARBITRATION

In the event of any disagreement between the Parties of this Agreement over the terms of the Agreement, the Parties shall submit, on the demand of either, the matter to arbitration in the following manner: The First Party shall appoint one arbitrator, and the Second Party shall appoint one arbitrator. The two arbitrators so appointed shall select a third, who shall be chairman of the board of arbitration. If the two arbitrators are unable to agree upon the third arbitrator, the Secretary of Health and Mental Hygiene of the State of Maryland shall be requested to designate such third arbitrator; and the written decision of the majority of the board of arbitration shall be final and binding upon both Parties.

ARTICLE XVIII. TERMS OF AGREEMENT

The Parties hereto mutually agree to update the Agreements dated May 6, 1963 and August 2, 1968 between Baltimore County and Howard County relating to sewerage services provided the Second Party by the First Party, effective the date of this Agreement, and further agree that any payments provided for in this Agreement shall be retroactive to July 1, 1975 and shall continue in force and effect until the parties hereto amend this Agreement or execute a new Agreement.

If it becomes necessary or desirable, in the opinion of either party, to amend this Agreement or execute a new Agreement, such party shall so notify the other in writing at least 30 days before the end of any calendar year. Such party shall accompany its written notification with a draft of its desired amendment or new Agreement. If the parties are unable to agree, the present Agreement shall continue in force. In the case of disagreement, either party may initiate arbitration proceedings according to Article XVII, above.

IN WITNESS WHEREOF, the Parties hereto have properly executed this Agreement as of the day, month and year first above-written.

Original Agreement approved by:
County Executive of Baltimore County
County Executive of Howard County

AMENDMENT TO SEWER AGREEMENT
BETWEEN BALTIMORE AND HOWARD COUNTIES
FOR CAPITAL EXPENDITURE ALLOCATION OF THE PATAPSCO RELIEF INTERCEPTOR

JUNE 5, 1982

THIS AGREEMENT, made this fifth day of June, 1982 by and between BALTIMORE COUNTY, MARYLAND, hereinafter referred to as the FIRST PARTY, and HOWARD COUNTY, MARYLAND, hereinafter referred to as the SECOND PARTY, each of said Parties a body corporate and politic of the State of Maryland.

WHEREAS, the First and Second Parties entered into an Agreement, dated June 4, 1979, to continue the operation of the jointly used sewerage system in the Patapsco Drainage Area between the Metropolitan District of Baltimore County and Howard County, and to establish methods for the computation and reimbursement of the costs incurred by the First Party in providing sewerage services to the Second Party; and

WHEREAS, the First Party will construct a Relief Interceptor paralleling the existing original Patapsco Interceptor from the confluence of Deep Run and Patapsco River downstream to the First Party's new Patapsco Pumping Station; and

WHEREAS, the First Party has designed said Facilities to accommodate certain existing and future flows from the territory of the Second Party; and

WHEREAS, the Second Party desires to connect to or otherwise use said Facilities; and

WHEREAS, Article X of the Sewer Agreement dated June 4, 1979 stipulates that the capital expenditures of jointly used sewerage facilities of the type herein referred to shall be allocated by the Design Flow Method as defined in said Sewer Agreement; and

WHEREAS, the U.S. Environmental Protection Agency, as a condition to awarding Grant No. C-240470010 for financial aid for the Facilities pursuant to P.L. 92-500, requires an amendment to said Sewer Agreement to include certain provisions; and

WHEREAS, Article XVIII of said Sewer Agreement provides that mutually agreeable amendments may be made to the Sewer Agreement;

NOW, THEREFORE, THIS AGREEMENT WITNESSETH:

THAT IN CONSIDERATION of the covenants, agreements and payments hereinafter set forth, it is mutually covenanted and agreed as follows:

A. The Sewer Agreement between Baltimore County and Howard County dated June 4, 1979 is hereby amended.

B. DEFINITION

"Capital expenditure" is hereby defined as in the Sewer Agreement.

C. PATAPSCO RELIEF INTERCEPTOR

a. The peak design-flow allocation of the reinforced Patapsco Interceptor System for each jurisdiction by manhole (MH) designation as described by the attached schematic is as follows:

See Page P-7.15

(Copied from the original document for publication in the Water & Sewerage Plan)

Section	Baltimore County (mgd)	Howard County (mgd)	Anne Arundel County (mgd)	BWI Airport (mgd)
MH 34848 to MH 49188	13.80	16.10	- mgd	- mgd
MH 49188 to MH 49187	13.80	27.60	3.22	- mgd
MH 49187 to MH 49185	13.80	27.60	3.22	2.30
MH 49185 to MH 49180	13.80	27.60	6.78	2.30
MH 49180 to MH 49171	24.98	27.60	6.78	2.30
MH 49171 to MH 49170	26.85	27.60	6.78	2.30
MH 49170 to MH 49165	29.11	27.60	7.93	2.30
MH 49165 to Pump Station	29.56	27.60	7.93	2.30

b. In accord with paragraph a. above, the Second Party's percentage share of capital expenditures by manhole sections is calculated as follows:

Section	Equity in Old Pipe (mgd-peak) (2)	Ultimate Requirement (mgd-peak) (3)	Capacity Increase (mgd-peak) (4)	Relief Capacity (mgd-peak) (5)	HOWARD County's Share (4) ÷ (5) = % (6)
MH 34838 to MH 49188	10.00	16.10	6.1	17.48	34.90%
MH 49188 to MH 49187	16.0	27.60	11.6	17.48	66.36%
MH 49187 to MH 49185	16.0	27.60	11.6	17.48	66.36%
MH 49185 to MH 49180	16.5	27.60	11.1	17.48	63.50%
MH 49180 to MH 49171	1.0	27.60	26.6	46.71	56.95%
MH 49171 to MH 49170	1.0	27.60	26.6	48.00	55.42%
MH 49170 to MH 49165	1.0	27.60	26.6	50.26	52.92%
MH 49165 to Pump Station	1.0	27.60	26.6	50.71	52.46%

c. The percentages in paragraph b. above shall be applied to capital expenditures as defined in the Sewer Agreement. For monthly progress billing purposes, an overall weighted average percentage shall be calculated for the Second Party by applying the percentages in paragraph b. to the bid price of each Section. At the completion of construction, actual shares shall be calculated, using the percentages in paragraph b. and actual costs for each Section. For common costs that cannot be assigned to specific Sections (such as administrative and/or engineering costs, etc.), an actual overall weighted-average percentage shall be determined from those costs which can be assigned. Any difference between billed shares and actual shares shall be settled at the time that the project is closed out.

d. The Second Party agrees to limit its peak flows in the reinforced Patapsco Interceptor System at any one time to its allocations as described in paragraph a. above during the service life of the System.

D. The Second Party recognizes the benefits it will receive from the construction of the Patapsco Relief Interceptor to be financed partially under U.S. Environmental Protection Agency's Grant No. C-240470010 to the First Party. Pursuant to the requirements of Public Law 92-500, the Second Party recognizes and accepts its obligation to impose appropriate sewer use charges and surcharges with constituent threshold limits as set forth in the Howard County Code at Section 20.307. Said threshold limits shall be in conformance with the Baltimore County Code (1978), Article 34, Division 5, as may be amended from time to time. The Second Party recognizes and accepts its obligation to enforce provisions with regard to industrial wastes as set forth in the Howard County Code, Section 18.122A. Said provisions shall be at least as stringent as those set forth in the Baltimore County Code.

Article 34, Division 5, as may be amended from time to time. The Second Party recognizes and accepts its obligation to implement whatever industrial cost recovery systems or pretreatment requirements may be required in the premises and territory by the U.S. Government Protection Agency.

IN WITNESS WHEREOF, the parties hereto have properly executed this Agreement as of the day, month and year first above written.

APPROVED:
BALTIMORE COUNTY, MARYLAND

ATTEST:

Patricia L. Gubner

By: Donald P. Hutchinson (Seal)
DONALD P. HUTCHINSON
County Executive 1-27-82

APPROVED AS TO FORM
AND LEGAL SUFFICIENCY:

Harold S. Shuman
Off. of Balt. County Solicitor

APPROVED: 1/18/82

Harry J. Pispel
HARRY J. PISPEL
Director of Public Works

ATTEST:

William E. Eagle
WILLIAM E. EAGLE
County Administrator

APPROVED:
HOWARD COUNTY, MARYLAND

By: J. Hugh Nichols (Seal)
J. HUGH NICHOLS
County Executive

APPROVED FOR SUFFICIENCY OF FUNDS:

Darrell Campbell
DARRELL CAMPBELL, Director
Office of Finance

RECOMMENDED FOR APPROVAL:

George F. Neimeyer 4-10-82
GEORGE F. NEIMEYER, Director
Department of Public Works

APPROVED FOR LEGAL SUFFICIENCY:

Timothy E. Welch
TIMOTHY E. WELCH
County Solicitor

PATAPSCO SYSTEM DESIGN FLOWS
DEEP RUN TO ANNAPOLIS ROAD

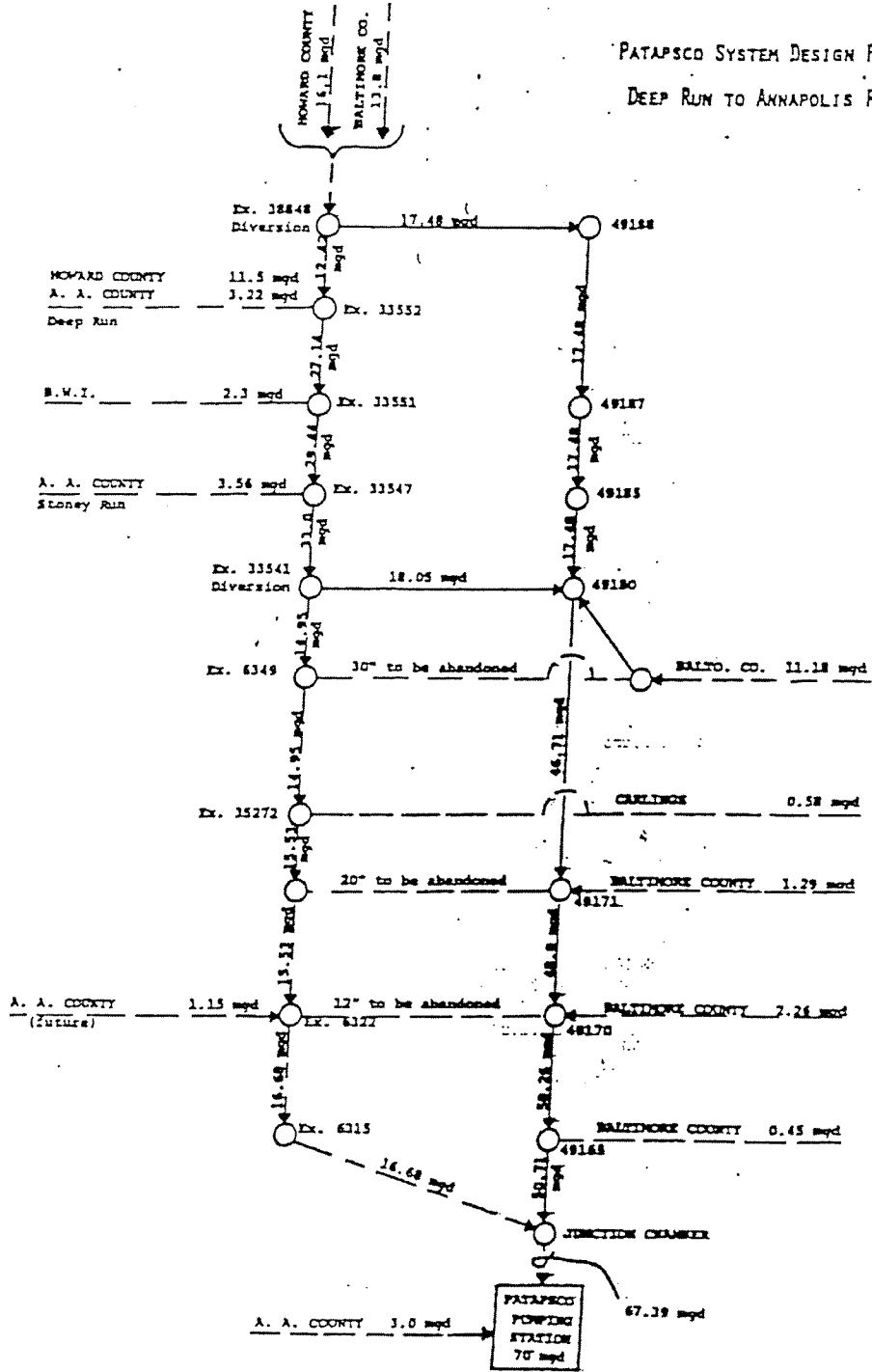

SEWERAGE AGREEMENT
BETWEEN BALTIMORE COUNTY AND HOWARD COUNTY

MAY 3, 1982

THIS AGREEMENT, made this third day of May, 1982, by and between Baltimore County, Maryland, a municipal corporation, hereinafter called "Baltimore County", and HOWARD COUNTY, MARYLAND, a body corporate and politic, hereinafter called "Howard County".

WHEREAS, Baltimore County and Howard County entered into two Agreements for the construction of the Patapsco Interceptor from Herberts Run to Suckers Branch (hereinafter referred to as "Patapsco Interceptor") which Agreements were dated May 6, 1963 (with a subsequent modification thereto dated February 28, 1964) and August 2, 1968 (hereinafter referred to respectively as the "1963 and 1968 Agreements"); and

WHEREAS, during the design of the Patapsco Interceptor the capacity was revised in two reaches without amending the Agreement and the actual cost sharing was based on the revised design capacity which is shown on Attachment A; and

WHEREAS, the Patapsco Interceptor from Herberts Run to Suckers Branch was constructed in accordance with the revised design capacity for both Baltimore County and Howard County for each reach of the Interceptor as shown on Attachment A; and

WHEREAS, the Baltimore County design sewage flow is less than projected and Baltimore County does not have the need for all the design capacity specified in the before stated Agreements in the Patapsco Interceptor from upstream of Deep Run to the Tiber Branch; and

WHEREAS, Howard County is desirous of purchasing some of Baltimore County's unneeded design capacity in the Patapsco Interceptor from upstream of Deep Run to Tiber Branch.

NOW, THEREFORE, THIS AGREEMENT WITNESSETH, that in consideration of the promises and conditions contained herein and other good and valuable consideration, the sufficiency of which is hereby acknowledged, the parties agree and covenant as follows:

1. The design capacity in the 1963 and 1968 Agreements are hereby amended to reflect the revised design capacity shown on Attachment A.
2. Baltimore County agrees to sell to Howard County the design capacity in the Patapsco Interceptor upstream of Deep Run to Tiber Branch as shown in Attachment B.
3. Howard County agrees to pay Baltimore County the sum of \$260,488 which is the cost of the design capacity shown on Attachment B. The cost of the design capacity includes the actual construction costs, engineering fees, right-of-way costs, etc., and is exclusive of Federal and State grants received for funding the various reaches of the Patapsco. The derivation of this cost is shown on Attachments C and D.

4. Howard County agrees to pay Baltimore County the dollar amount stated in Item 2 within sixty (60) days of the date of execution of this Agreement.
5. This Agreement shall inure to and be binding upon the parties hereto, their successors and assigns.
6. This Agreement was made and entered into in Maryland and is to be construed under the laws of Maryland.

IN WITNESS WHEREOF, the parties hereto have caused these presents to be executed by their proper officers thereunto duly authorized the day and year first above written.

ATTEST:

HOWARD COUNTY, MARYLAND

s/William E. Eakle
 William E. Eakle
 County Administrator

s/J. Hugh Nichols
 By: J. Hugh Nichols (Seal)
 County Executive

APPROVED:

APPROVED FOR LEGAL SUFFICIENCY
 this 6th day of April, 1982.

s/George F. Neimeyer 4-7-82
 George F. Neimeyer, Director
 Department of Public Works

s/Timothy E. Welsh
 Timothy Welsh
 County Solicitor

APPROVED FOR SUFFICIENCY OF FUNDS

s/J. D. Campbell 4-7-82
 J. Darrell Campbell, Director
 Office of Finance

ATTEST:

APPROVED:
 BALTIMORE COUNTY, MARYLAND

s/Patricia L. Kirkner

By: s/Donald P. Hutchinson (Seal)
 DONALD P. HUTCHINSON 5-3-82
 County Executive

APPROVED AS TO FORM
 AND LEGAL SUFFICIENCY:

APPROVED:

s/Stanley J. Schapiro

s/Harry J. Pistel
 HARRY J. PISTEL
 Director of Public Works

ATTACHMENT A

DESIGN CAPACITY BEFORE SALE IN THE PATAPSCO INTERCEPTOR
FROM HERBERTS RUN TO SUCKERS BRANCH

From	Reach To	Design Capacity (mgd)			
		Baltimore County Per Agreement	Revised*	Howard County Per Agreement	Revised*
Herberts Run	Deep Run	**	***	**	***
Deep Run	Stillhouse Run	31.5	-	13.0	-
Stillhouse Run	Bull Branch	30.8	-	13.0	-
Bull Branch	Santee Branch	29.4	-	12.0	-
Santee Branch	Oak Forest Branch	27.6	-	12.0	-
Oak Forest Branch	Thistle Branch	26.0	-	12.0	-
Thistle Branch	3000 feet east of Tiber Branch	25.9	-	12.0	-
3000 feet east of Tiber Branch	Tiber Branch	24.9	-	10.0	12.0
Tiber Branch	Suckers Branch	17.9	24.9	10.0	3.0

*Revised by letters. Actual cost sharing was based on revised design capacity.

**50% by each party.

***Design capacity is increased through the Amendment to Sewer Agreement dated June 4, 1979 between Baltimore and Howard counties for Capital Expenditure Allocation of the Patapsco Relief Interceptor which Amendment is dated April 1982.

ATTACHMENT B

DESIGN CAPACITY AFTER SALE IN THE PATAPSCO INTERCEPTOR
FROM DEEP RUN TO SUCKERS BRANCH

From	To	Design Capacity Being Sold	Design Capacity (mgd)	
			Baltimore County	Howard County
Upstream of Deep Run	Stillhouse Run	3.1	28.4	16.1
Stillhouse Run	Bull Branch	3.1	27.7	16.1
Bull Branch	Santee Branch	3.1	26.3	15.1
Santee Branch	Oak Forest Branch	3.1	22.9	15.1
Oak Forest Branch	Thistle Branch	3.1	22.9	15.1
Thistle Branch	3000 feet east of Tiber Branch	3.1	22.8	15.1
3000 feet east of Tiber Branch	Tiber Branch	3.1	21.8	15.1
Tiber Branch	Suckers Branch	1.0	23.9	4.0

ATTACHMENT C

DERIVATION OF CONSTRUCTION COSTS FOR THE ADDITIONAL CAPACITY

Contract No.	Contract Costs		Local Cost (2) - (3)	Baltimore County MCD- A	Cost/MCD \$ (7) + (5)	Additional Capacity for Howard County mgd (9)	Construction Cost \$ (8) x (9)
	Total (2)	Federal & State (3)					
1057 MCDAB8 to 39206							
	441,975	262,507	179,468	31.5-69.7	3,971	3.1	12,310
1058	510,971	354,655	156,316	30.8-70.3	3,568	3.1	11,061
1059	206,698	202,636	84,062	29.4-71.0	2,030	3.1	6,293
1060	508,515	393,946	114,569	27.6-69.7	2,893	3.1	8,968
145	1,124,503	859,075	265,428	26.0-64.4	6,982	3.1	21,644
146	792,817	611,672	181,145	25.9-64.3	4,777	3.1	14,809
25 Part A	-	-	-	24.9-67.5	6,044	3.1	18,736
25 Part B	-	-	-	24.9-69.3	3,199	1.0	3,199

Numbers in parentheses are column numbers.

ATTACHMENT D

DERIVATION OF THE SELLING PRICE

Contract No.	ENR Index	Escalated Cost	Age (Years)	Accumulated Depreciation (3) x (4) ÷ 75	Revised Selling Price (3) - (5)
(1)	(2)	(3)	(4)	(5)	(6)
1057 MH34848 to 39206	2.89	\$35,576	12	\$ 5,692	\$29,884
1058	3.20	35,395	13	6,135	29,260
1059	3.20	20,138	13	3,491	16,647
1060	2.89	25,918	12	4,147	21,771
145	3.20	69,261	13	12,005	57,256
146	3.20	47,389	13	8,214	39,175
25 Part A	3.92	73,445	17	16,648	56,797
25 Part B	3.92	<u>12,541</u>	17	<u>2,843</u>	<u>9,698</u>
		<u>\$319,663</u>		<u>\$59,175</u>	<u>\$260,488</u>

Numbers in parentheses are column numbers.

EXHIBIT 7

**Anne Arundel County &
Howard County Sewer Agreement**

AA - Howard Co.
Sewer Agreement

Contract 22-S

THIS AGREEMENT, made this 28 day of August, 1963 by and between the HOWARD COUNTY METROPOLITAN COMMISSION, hereinafter called "Howard" and the ANNE ARUNDEL COUNTY SANITARY COMMISSION, hereinafter called "Anne Arundel".

WHEREAS, Howard and Anne Arundel are desirous of constructing a sewerage system in the Deep Run Drainage Area, a part of the Patapsco River Drainage Area, and

WHEREAS, the Drainage Area of Deep Run lies within both Howard County and Anne Arundel County, and

WHEREAS, Howard and Anne Arundel are desirous of entering into an agreement to construct the Deep Run Interceptor beginning in the vicinity of the confluence of Deep Run and the Patapsco River and running upstream to the upper reaches of Deep Run for the purpose of conveying sewage originating in both Counties through the said interceptor and thence downstream from said confluence of Deep Run and the Patapsco River to the facilities of Baltimore County and Baltimore City for the eventual disposal thereof;

WHEREAS, the said parties have agreed hereto that the capital costs and other charges and expenses in connection therewith shall be apportioned among them;

NOW, THEREFORE, THIS AGREEMENT WITNESSETH, that in consideration of the premises and the mutual benefits accruing to each of the parties hereto, they agree and covenant as follows:

HOWARD AGREES:

Item 1 - To award Contract No. 22-S under which the Deep Run Interceptor will be constructed from the vicinity of Elkridge to Baltimore County's Patapsco Interceptor as outlined in the agreement between Baltimore County and Howard County dated May 6, 1963, and to furnish Anne Arundel with an itemized statement of the cost thereof, which said total cost will be paid by Howard and Anne Arundel as determined by the ratio of the respective

Counties' capacity of the total capacity of the constructed interceptor.

Item 2 - To provide Anne Arundel with a peak capacity of 4,42 mgd in that portion of the Deep Run Interceptor to be constructed under Contract No. 22-5.

Item 3 - To undertake at a future time the construction of the Deep Run Interceptor upstream from the terminus as constructed under Contract No. 22-5 to any point or points as mutually agreed upon and to provide Anne Arundel with such capacity in the extended interceptor as requested in writing by Anne Arundel and to furnish Anne Arundel with cost estimates which shall be the basis of deposits to be made by Anne Arundel prior to the award of construction contracts and to furnish an itemized statement of the final cost thereof, which said cost shall be apportioned at the same ratio as set forth in Item 1.

Item 4 - To apply for all available Federal and State Grants of aid to assist in the cost of construction of the Deep Run Interceptor and to credit Anne Arundel its proportionate share of the Grants where applicable.

Item 5 - To maintain and operate the Deep Run Interceptor.

ANNE ARUNDEL COUNTY:

Item 6 - To advance the sum of \$40,000 to Howard prior to the award of Contract No. 22-5 by Howard, said amount being the estimated cost of Anne Arundel's participation in the construction of the Deep Run Interceptor under the said contract and to pay Howard within 60 days upon receipt of final audit any moneys due Howard in the event that the advanced \$40,000 is not sufficient to cover Anne Arundel's cost of participation in Contract No. 22-5, it being understood, however, that in the event the advanced sum of \$40,000 is in excess of Anne Arundel's proportionate share of cost of the Deep Run Interceptor that Howard will return the difference between the advanced \$40,000 and the actual amount within 60 days upon completion of the contract.

Item 7 - To meter all sewage originating in Anne Arundel County at the various points of discharge into the Deep Run Interceptor, such metering to be the basis for determining the total volume of sewage discharged by Anne Arundel into the Deep Run Interceptor.

Item 8 - To pay Howard its proportionate share of the maintenance

and operating costs of the Deep Run Interceptor, such payment to be made semi-annually and within 60 days upon receipt of the bill from Howard.

Item 9 - To pay Howard all applicable charges which Howard will be assessed by Baltimore County for the conveyance and disposal of sewage originating in Anne Arundel County and conveyed by facilities in Baltimore County discharging into facilities of Baltimore City for disposal by Baltimore City, in accordance with the agreement between Baltimore County and Howard County dated May 6, 1963.

Item 10 - To pay Howard its proportionate share of project costs of extending the Deep Run Interceptor upstream from the terminus of Contract No. 22-5, the amount and method of such payment to be determined as outlined in Item 1 and Item 6 hereof.

HOWARD COUNTY

ATTEST:

Erskine B. Meyer
Secretary-Treasurer

Approved as to Form and Legal Sufficiency
this 2nd day of August, 1963.

Robert E. Wieder
Counsel for the Commission

ATTEST:

E. Hobson Hartman Jr.
Clerk

Approved as to Form and Legal Sufficiency
this 22nd day of August, 1963.

Robert E. Wieder
Counsel for the County Commissioners

HOWARD COUNTY METROPOLITAN COMMISSION

By: Roger V. Lamm
Chairman

John C. Moser
Member

J. P. [unclear]
Member

HOWARD COUNTY BOARD OF COUNTY COMMISSIONERS

By: Charles E. Miller
Chairman

J. Hubert Black
Member

David H. Zorn
Member

ANNE ARUNDEL COUNTY

ATTEST:

John F. [unclear]

Approved as to Form and Legal Sufficiency
this 2nd day of August, 1963.

John F. [unclear]
Counsel for the Anne Arundel County
Sanitary Commission

ATTEST:

Luoy H. [unclear]

Approved as to Form and Legal Sufficiency
this 2nd day of August, 1963.

James W. [unclear]
County Collector

ANNE ARUNDEL COUNTY SANITARY COMMISSION

By: George [unclear]
Chairman

ANNE ARUNDEL BOARD OF COUNTY COMMISSIONERS

By: James P. Collier
President

THIS AGREEMENT made this 30th day of March, 1979, by

and between HOWARD COUNTY, MARYLAND, party of the first part, and ANNE ARUNDEL COUNTY, MARYLAND, party of the second part, witnesseth that

WHEREAS, the Howard County Metropolitan Commission and the Anne Arundel County Sanitary Commission did, on the 28th day of August, 1963 (Contract No. 22-S), and the Howard County Metropolitan Commission and the Anne Arundel County Sanitary Commission did, on the 30th day of June, 1970, (Contract No. 181-S), and the Howard County Government and the Anne Arundel County Government did, on the 11th day of December, 1973, (Contract No. 291-S), enter into agreements to share the cost and equitable interest in a sewage system in the Deep Run Drainage Area, a part of the Patapsco Drainage Area and lying along the boundary between Howard County and Anne Arundel County, and

WHEREAS, a portion of the said improvement known as the Deep Run Interceptor has heretofore been constructed, pursuant to the agreements aforesaid, and

WHEREAS, the Howard County Metropolitan Commission has been superseded in its functions by the Charter Government of Howard County, and

WHEREAS, the Anne Arundel County Sanitary Commission has been superseded in its functions by the Charter Government of Anne Arundel County, and

WHEREAS, it has now been determined by the parties hereto to be necessary and desirable to construct a further section of the said Deep Run Interceptor, pursuant to contract specifications known as Capital Project S-4-6046, Licking Creek Interceptor, Contract No. 580-S, as prepared by Whitman, Requardt and Associates, Engineers of Baltimore, Maryland, as shown on Exhibit A within the noted limits, and

WHEREAS, Capital Project S-4-6046 is in part eligible for Federal grant funds under PL 92-500 and State grant funds under C-240365, and

WHEREAS, application for such grants has been made by Howard County and approved by the Environmental Protection Agency and State of Maryland;

NOW, THEREFORE, in consideration of the premises and the mutual

AA County -
Howard County
Sewer Agreement
Contract 580-S

405755 CP40 R02 T16:00
HQ4/23/79

benefits accruing to each of the parties hereto and other good and valuable consideration, it is hereby agreed and covenanted as follows:

1. Wherever the word "cost" is used in this Agreement, it shall mean all expenses, actual and constructive, necessary to the procurement, construction and installation of the designated sewerage system and appurtenances. The said expenses shall include, but are not limited to, such elements as follows: material, labor, inspection, acquisition of rights-of-way, land, office and field engineerings, extra work orders, and other expenses directly related to the project. Such costs do not include maintenance charges incurred after the completion and final acceptance of the project. Legal title to the sewerage system referred to in this Agreement shall be and remain in Howard County.

2. The party of the second part agrees to contribute as its share of the cost of the Licking Creek Interceptor as described in the specifications and plans, Howard County Contract No. 580-S, hereto attached, anticipating a total project cost of \$860,000 in the manner hereinafter set forth and which amount may be adjusted on the basis of actual costs as hereinafter described.

3. The said contract (Contract No. 580-S), for the construction of this section of the Deep Run Interceptor is to be separated into five (5) parts - Part A, B, C, D, and E. Part A is the segment of the interceptor to be constructed from Manhole No. 6569 of the existing sewer located at Deep Run and built under Howard County Contract No. 291-S to Manhole No. 7866 of Contract No. 580-S near the Howard/Anne Arundel County line. The cost of Part A shall be borne by both Anne Arundel County and Howard County in accordance to the percentages shown in item 4. The cost of Part B and C of the said contract, from Manhole No. 7866 near the County line to Montevideo Road and along Montevideo Road shall be borne entirely by Howard County. Part D is the house connections in Howard County; the cost of which shall be borne entirely by Howard County. Part E is a list of contingency unit price items for the entire contract. The cost of Part E shall be tabulated

by the actual use in conjunction with Parts A, B, C and D and the cost sharing shall be borne as specified in item 4 for each Part.

4. The party of the first part allocates the peak flow capacity in the following manner:

Part A - Deep Run to County Line

Howard County	1.76 MGD = 36.8%
Anne Arundel County	<u>3.02 MGD = 63.2%</u>
	4.78 MGD = 100.0%

Part B, C and D - County Line to Montevideo Road

Howard County	1.76 MGD = 100.0%
Anne Arundel County	<u>0.00 MGD = 0.0%</u>
	1.76 MGD = 100.0%

5. The anticipated cost of Contract No. 580-S, excluding the metering devices, is estimated at \$860,000 of which \$400,000 is estimated to be the cost of Part A. The cost to be borne by each of the parties hereto of Part A is based on the aforementioned estimate and the percentage of flow capacity allocated to each as follows:

Part A - Deep Run to County Line

Howard County	36.8%	\$147,200
Anne Arundel County	<u>63.2%</u>	<u>\$252,800</u>
Total	100.0%	\$400,000

6. The party of the second part shall pay to the party of the first part, on a cash need basis, within thirty (30) days after receipt of invoice, its pro rata share of project costs of Part A and Part E of Contract 580-S (Licking Creek Interceptor) as above described.

7. The party of the first part, upon receipt of grant monies from state and federal agencies shall pay unto Anne Arundel County its appropriate share, based upon allocations of capacities as set forth in Item 4 above.

8. In the event that the sum paid, pursuant to this Agreement, by the party of the second part on a cash need basis is in excess of the

proportionate share of costs to Anne Arundel County of Part A of the Licking Creek Interceptor, then the party of the first part will return the excess payment to Anne Arundel County within sixty (60) days after the completion of the final audit of the said contract by the Environmental Protection Agency and in the event that the said final audit of the said contract concludes that the sum paid by the party of the second part, on a cash need basis, is insufficient to cover the proportionate share of Anne Arundel County's costs of the Licking Creek Interceptor, then the party of the second part agrees to pay over to the party of the first part within (60) days of notification of said final audit the balance due by it thereon. In the event that additional funds are required in excess of those allocated by Anne Arundel County Council, sufficient additional time will be provided to Anne Arundel County to allocate the additional funds in accordance with legislation then in effect.

9. (a) The party of the first part agrees to install at Anne Arundel County cost, two metering devices estimated at \$30,000 each, one of which will be installed in the vicinity of Manhole 7867 of Contract No. 580-S and will measure flow from Howard County. The second metering device will be installed in the vicinity of Manhole No. 6569 of Contract No. 291-S to measure the total discharge of the Licking Creek Interceptor sewer. The party of the first part agrees to seek State and Federal grant funds for the metering devices and to credit any grant monies received in accordance with paragraphs 7 and 8. Maintenance and reading of the meters shall be performed by the party of the first part and paid for by the party of the second part. The party of the first part shall grant reasonable access to the party of the second part in order to inspect the facilities or to read the meters.

(b) The party of the first part shall bill the party of the second part annually for all wastes entering the Licking Creek Interceptor (Contract 580-S) from Anne Arundel County as determined by taking the difference between the readings of the aforementioned metering devices.

Manholes
 {
 Dorsey
Meters

This billing will be at the same unit rate paid by Howard County to Baltimore County for discharging said wastes into the Baltimore County system, plus the actual cost of billing and handling of invoices. This invoice will be furnished after each fiscal period for the preceding fiscal year charges.

(c) The party of the first part shall bill the party of the second part annually for Anne Arundel County's share of the costs of all maintenance performed on Part A of the Licking Creek Interceptor, such share to be based upon flow capacity allocated to Anne Arundel County in paragraph 4 above. The invoices for these costs will be furnished after each fiscal period for the preceding fiscal year charges.

10. Prior to initiation of construction of Part A, the party of the first part shall submit the plans and specifications to the party of the second part for review and approval.

AS WITNESS the Hand and Seals of the parties hereto.

ATTEST:

HOWARD COUNTY

William E. Eakle
William E. Eakle
County Administrator

By J. Hugh Nichols 3/30/79
J. Hugh Nichols (Seal)
County Executive

APPROVED:

George F. Neimeyer
George F. Neimeyer, Director
Department of Public Works

J. Darrell Campbell 3/30/79
J. Darrell Campbell, Director
Office of Finance

APPROVED for Legal Sufficiency this
30 day of March, 1979.

Richard J. Wilkinson
Richard J. Wilkinson
Office of Law

ALAN M. SCHWARTZ

ANNE ARUNDEL COUNTY

Mary W. Craig

By Robert A. Pascal (Seal)
Robert A. Pascal
County Executive

APPROVED:

Anthony T. Ferrara
Anthony T. Ferrara, Director
Department of Public Works

APPROVED AS TO FORM AND LEGAL
SUFFICIENCY

Judith W. Hy (Seal)
Anne Arundel County Solicitor

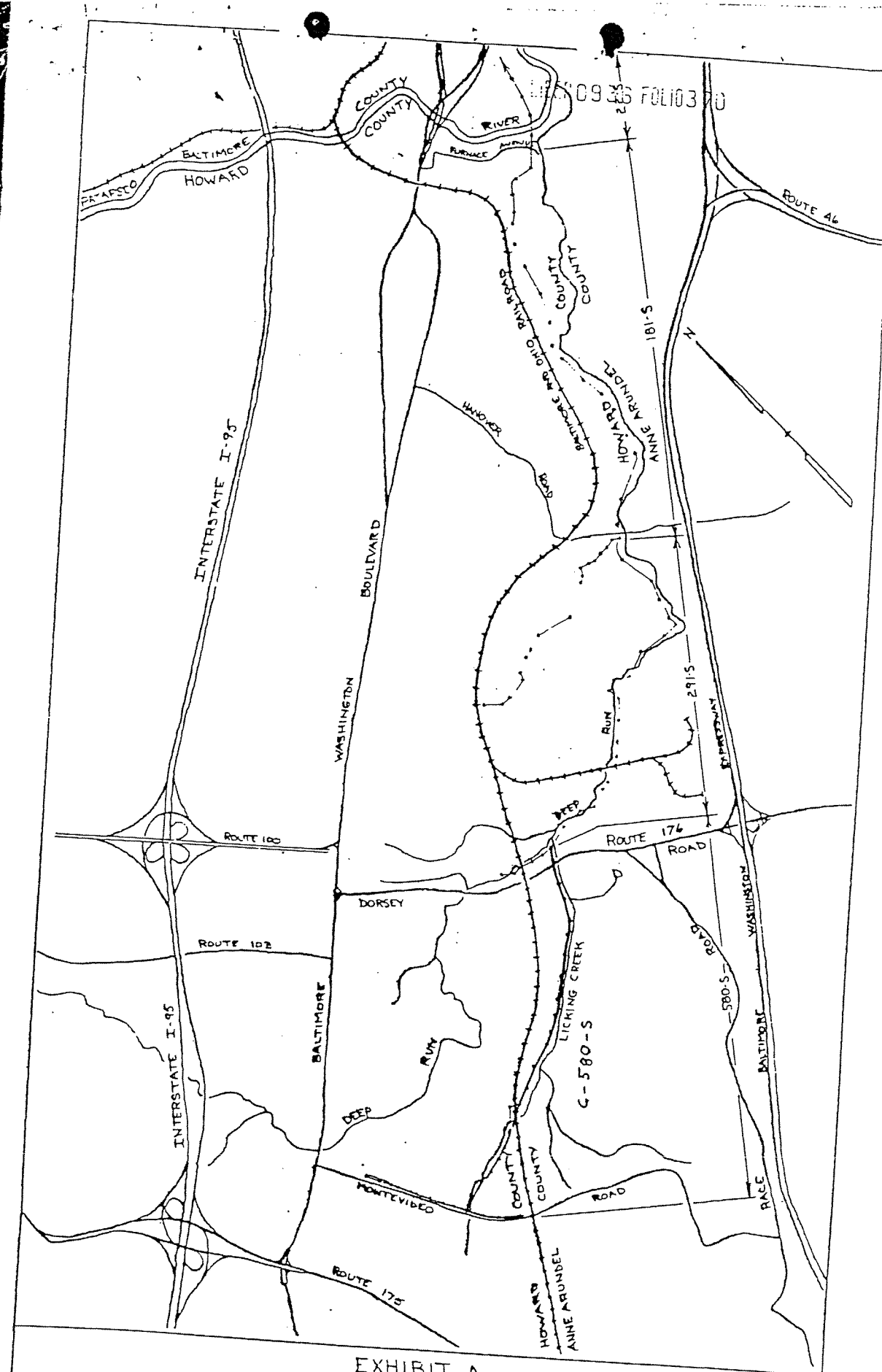

EXHIBIT A
 TO THE AGREEMENT MADE THIS 30TH DAY OF March, 1978.

Mailed to Dept of Public Works

SCALE: 1/2" = 1 MILE

AA County -
Howard County
Sewer Agreement
Contract
291-S

RECEIVED
JAN 3 1974
HOWARD COUNTY
DEPT. PUBLIC WORKS

THIS AGREEMENT made this 11th day of DECEMBER, in the year
Nineteen Hundred and Seventy - 73, by and between HOWARD COUNTY,
MARYLAND, party of the first part; and ANNE ARUNDEL COUNTY, MARYLAND,
party of the second part.

WITNESSETH:

WHEREAS, the Howard County Metropolitan Commission and the Anne
Arundel County Sanitary Commission did on the 28th day of August, 1962,
enter into an agreement to share the cost of construction and equitable
interest in a sewerage system in the Deep Run Drainage Area, a part
of the Patapsco River Drainage Area and lying along the boundary
between Howard County and Anne Arundel County; and

WHEREAS, the Howard County Metropolitan Commission has been
superseded in its functions by the Charter Government of Howard County;
and

WHEREAS, the Anne Arundel County Sanitary Commission has been
superseded in its functions by the Charter Government of Anne Arundel
County; and

WHEREAS, Howard County, Maryland and Anne Arundel County, Maryland,
did on the 30th day of June, 1970, enter into an agreement to share
the cost of construction and equitable interest in an extension of
the said sewerage system in the Deep Run Drainage Area; and

WHEREAS, a portion of the said improvements known as the Deep Run
Interceptor has heretofore been constructed pursuant to the agreements
aforesaid; and

WHEREAS, it has now been determined by the parties hereto to be
necessary and desirable to construct a further section of the Deep Run
Interceptor, pursuant to Contract Specifications known as Contract No.
291-S, as prepared by Whitman, Requardt & Associates, Engineers of
Baltimore City, Maryland, as amended through the date of November 1, 1972;
and

NOW, THEREFORE, in consideration of the premises and mutual benefits
accruing to each of the parties hereto and other good and valuable
considerations, it is hereby agreed and covenanted as follows:

1. Whenever the word cost is used in this agreement, it shall mean all expenses, actual and constructive, necessary to the procurement, construction and installation of the designated sewerage system and appurtenances. The said expenses shall include, but are not limited to, such elements as follows: material, labor, acquisition of rights-of-way, land, office and field engineering, inspection, extra work orders, and other expenses directly related to the project. Such costs do not include maintenance charges that occur after the completion and the final acceptance of the project. The legal title to the sewerage system referred to in this agreement shall be and remain in Howard County.

2. The party of the second part agrees to contribute as its share of the cost of construction of the Deep Run Interceptor as described in the Specifications and Plans, Howard County Contract 291-S, hereto attached, anticipating a total project cost of \$765,288.00 based on bids heretofore received by Howard County. The exact amount for which the party of the second part shall be responsible shall be determined in the manner hereinafter set forth, which amount may be adjusted on the basis of actual cost as described.

3. The said contract (Contract 291-S) for the construction of this section of the Deep Run Interceptor is to be separated into two (2) parts - Part A and Part B. Part A is that segment to be constructed from the existing sewer located at Hanover Road to a point at Licking Creek. The cost of the construction of Part A shall be borne by both Anne Arundel County and Howard County in a manner hereinafter described. The cost for the construction of Part B of the said contract, from Licking Creek to the vicinity of Dorsey, Maryland, shall be borne entirely by Howard County, Maryland.

4. Part A of the said contract is divided into two (2) design sections which establishes the peak design flow. The party of the first part allocates the flow capacity in the following manner:

Design Section I - Hanover Road to Piney Run

Howard County	12.48 MGD	=	46.22%
Anne Arundel County	14.52 MGD	=	53.78%
	27.00 MGD	=	100.00%

Design Section II - Piney Run to Licking Creek

Howard County	11.96 MGD	=	61.33%
Anne Arundel County	7.54 MGD	=	38.67%
	19.50 MGD	=	100.00%

5. The respective cost of construction to be borne by each of the parties hereto, based on the low bid cost of \$765,288.00 for Part A of the said contract, and based on the percentage of flow capacity allocated to each is as follows:

Design Section I - Hanover Road to Piney Run (\$276,287.40)

Howard County	46.22%	=	\$127,700.04
Anne Arundel County	53.78%	=	148,587.36
			\$276,287.40

Design Section II - Piney Run to Licking Creek (\$489,000.60)

Howard County	61.33%	=	\$299,904.07
Anne Arundel County	38.67%	=	189,096.53
			\$489,000.60

Items in Part A of the contract proposal applicable to Design Section I are: Item 1 through 4, Item 11, Item 14, Item 16, 21% of Item 18 and 36% of Item 19.

Items in Part A of the contract proposal applicable to Design Section II are: Item 5 through 10, Item 12, Item 13, Item 15, Item 17 and 79% of Item 18 and 64% of Item 19.

6. The party of the first part agrees to credit to Anne Arundel County's contribution to the construction of this section of the Deep Run Interceptor an appropriate share, based upon the allocation of capacities as set forth above, any grant monies received by the party of the first part from State and Federal Agencies for the construction cost of this section of the Deep Run Interceptor.

7. The party of the second part shall pay to the party of the first part, on a cash need basis, within 15 days after receipt of invoice, its pro-rata share of the construction cost of this section of the Deep Run Interceptor as above described.

8. In the event that the sum paid, pursuant to this Agreement, by the party of the second part on a cash need basis in an excess of the proportionate share of costs to Anne Arundel County of this section of the Deep Run Interceptor, then the party of the first part will return the excess payment to Anne Arundel County within sixty (60) days after the completion of the final audit of the said contract by the Environmental Protection Agency and in the event that the said final audit of the said contract shows that the sum paid by the party of the second part, on a cash need basis, is insufficient to cover the proportionate share of Anne Arundel County's cost of this section of the Deep Run Interceptor, then the party of the second part agrees to pay over to the party of the first part within sixty (60) days of notification of said final audit the balance due by it thereon.

9. (a) The party of the second part agrees to install at its cost metering devices at all points of connection to the Deep Run Interceptor.

(b) The party of the first part shall bill the party of the second part annually for all wastes entering the Deep Run Interceptor from Anne Arundel County through said metering devices at the same unit flow rate paid by Howard County to Baltimore County for discharging said wastes into the Baltimore County System, plus the actual cost of billing and handling of invoices. This invoice will be furnished after each fiscal period for the preceeding year's charges.

(c) The party of the first part shall bill the party of the second part annually for Anne Arundel County's share of the costs of all maintenance performed on the Deep Run Interceptor, such share to be based upon the percentage of flow capacity allocated to Anne Arundel County in paragraph 4 above. The invoices for these costs will be furnished after each fiscal period for the preceeding year's charges.

AS WITNESS the Hands and Seals of the parties hereto.

ATTEST:

HOWARD COUNTY, MARYLAND

Albert K. Wood
Albert K. Wood,
County Administrator

BY: Omar J. Jones (SEAL)
Omar J. Jones,
County Executive

APPROVED:

William A. Altman 11/27/73
William A. Altman, Director
Department of Public Works

APPROVED FOR FUNDS:

J. Darrell Campbell 12/1/73
J. Darrell Campbell, Director
Office of Finance

APPROVED for Legal Sufficiency this

21st day of November, 1973.

Robert E. Wieder
Robert E. Wieder,
Office of Law

ATTEST:

ANNE ARUNDEL COUNTY

Mary H. Gray

BY: James B. Stott (SEAL)
11/16/73 Anne Arundel County Executive

APPROVED:

George F. Neizer
Director of Public Works

APPROVED AS TO FORM AND
AND LEGAL SUFFICIENCY:

Robert J. Dore
Anne Arundel County Solicitor

APPROVED FOR AVAILABILITY OF FUNDS:

Donald P. Carter
Anne Arundel County Controller
(Subject to receipt of Aid Funds)

7A County - Howard
County Sewer
Agreement
Contract 181-S

THIS AGREEMENT, Made this 30th day of June, 1970, by and between HOWARD COUNTY, MARYLAND, party of the first part, and ANNE ARUNDEL COUNTY, MARYLAND, party of the second part, Witnesseth, that

WHEREAS, the Howard County Metropolitan Commission and the Anne Arundel County Sanitary Commission did, on the 28th day of August, 1963, enter into an agreement to share the cost of construction and equitable interest in a sewerage system in the Deep Run drainage area, a part of the Patapsco River drainage area and lying along the boundary between Howard County and Anne Arundel County, and

WHEREAS, a portion of the said improvement known as the Deep Run Interceptor has heretofore been constructed, pursuant to the agreement aforesaid, and

WHEREAS, it has now been determined by the parties hereto to be necessary and desirable to construct a further section of the said Deep Run Interceptor, pursuant to contract specifications known as Contract No. 181-S, as prepared by Whitman Requardt and Associates, Engineers, of Baltimore, Maryland, as amended through the date of August 6, 1969, and

WHEREAS, the Howard County Metropolitan Commission has been superseded in its functions by the Charter Government of Howard County, and

WHEREAS, the Anne Arundel County Sanitary Commission has been superseded in its functions by the Charter Government of Anne Arundel County,

NOW, THEREFORE, in consideration of the premises and the mutual benefits accruing to each of the parties hereto and other good and valuable consideration, it is hereby agreed and covenanted as follows:

1. Wherever the word "cost" is used in this Agreement, it shall mean all expenses, actual and constructive, necessary to the procurement, construction and installation of the designated sewerage system and appurtenances. The said expenses shall include, but are not limited to, such elements as follows: material, labor, acquisition of rights-of-way, land, office and field engineering, inspection, extra work orders, and other expenses directly

related to the project. Such costs do not include maintenance charges incurred after the completion and final acceptance of the project. Legal title to the sewerage system referred to in this Agreement shall be and remain in Howard County.

2. The party of the second part agrees to contribute as its share of the cost of construction of the Deep Run Interceptor as described in the specifications and plans hereto attached, anticipating a total project cost of \$1,000,000, based on estimates heretofore prepared by Howard County, the sum of \$423,300 in the manner hereinafter set forth and which amount may be adjusted on the basis of actual return costs as hereinafter described.

3. The party of the first part allocates to the party of the second part the availability of a peak capacity of 14.52 mgd, the said capacity representing current engineering estimate made by Anne Arundel County of the requirements of Anne Arundel County in the said Deep Run Interceptor, and also representing 42.33 per cent of the total designed capacity thereof.

Ho.Co. 19.78
AA Co. 14.52
34.30

4. The party of the first part agrees to credit to Anne Arundel County's contribution to the construction of the Deep Run Interceptor an appropriate share, based upon allocation of capacities as set forth above, of grant monies received by the party of the first part from state and federal agencies for the project costs of the second section of the Deep Run Interceptor, that is, the section between Elkridge and the confluence of Deep Run and Shallow Run.

5. The party of the second part shall pay to the party of the first part, on a cash need basis, within fifteen (15) days after receipt of invoice its pro rata share of project costs of construction of the Deep Run Interceptor as above described.

6. In the event that the sum paid, pursuant to this Agreement, by the party of the second part on a cash need basis is in excess of the proportionate share of costs to Anne Arundel County of the second section of the Deep Run Interceptor, then the party of the first part will return the excess payment

to Anne Arundel County within sixty (60) days after the completion of the final audit of the said contract by the FWPCA, and in the event that the said final audit of the said contract indicates that the sum paid by the party of the second part, on a cash need basis, is insufficient to cover the proportionate share of Anne Arundel County's costs of the Deep Run Interceptor, Section 2, then the party of the second part agrees to pay over to the party of the first part within sixty (60) days of notification of said final audit the balance due by it thereon.

HOWARD COUNTY

APPROVED:

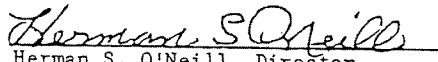
Herman S. O'Neill, Director
Department of Public Works

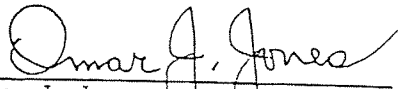

Omar J. Jones
County Executive

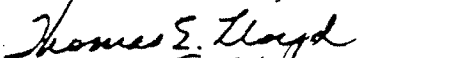
APPROVED:
For Legal Sufficiency:

County Solicitor

ANNE ARUNDEL COUNTY

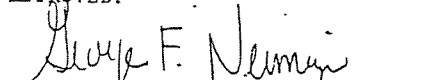
APPROVED:

George F. Neimeyer, Director
Department of Public Works

ANNE ARUNDEL COUNTY, MARYLAND

APPROVED FOR FUNDS:
(Funds not to exceed \$423,300.00)

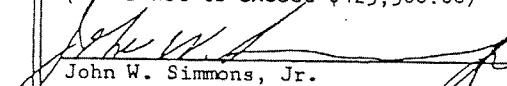
John W. Simmons, Jr.
Controller

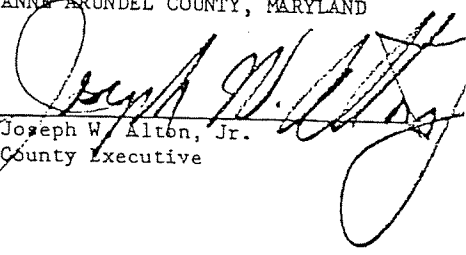
By: 
Joseph W. Altón, Jr.
County Executive

APPROVED FOR LEGAL FORM
AND SUFFICIENCY:



Robert E. Dammeier
Deputy Solicitor

EXHIBIT 8

**Patapsco WWTP Service Area
Memorandum of Understanding**

Patapsco Sewerage System
Memorandum of Understanding

Whereas, the multi-jurisdictional use of the Patapsco wastewater treatment facilities requires cooperative agreements for sharing the use of available sewage capacities, and

Whereas, Baltimore City, Baltimore County, Howard County, Anne Arundel County, and the Department of Health and Mental Hygiene agree that there is a need to formalize these cooperative agreements into a Memorandum of Understanding which specifies how capacities established by the State will be shared amongst the jurisdictions, and

Whereas, Baltimore City, Baltimore County, Howard County and Anne Arundel County recognize and agree that this Memorandum of Understanding does not supersede, amend, add to or delete from existing agreements for facilities covered by the Memorandum of Understanding and in the event of any conflict the terms of the existing contracts will govern, and

Whereas, the previous Memorandum of Understanding dated May 4, 1978, and revised June 16, 1978, has become obsolete, and

Whereas, the Patapsco Wastewater Treatment Plant expansion and upgrading to 70 mgd has been completed, and

Whereas, the Southwest Diversion project has been completed, and

Whereas, the Baltimore County Patapsco Pump Station, force main and Patapsco relief interceptor has been completed, and

Whereas, Baltimore City has been ordered by the Director of the Water Management Administration to complete construction of all three Gwynns Falls relief interceptor contracts by May 4, 1984, and

Whereas, the Environmental Protection Agency (EPA) and the State of Maryland have provided funding for the Patapsco Treatment Plant upgrading and expansion to 70 mgd, the Baltimore County Patapsco Pump Station, force main and relief interceptor, the Southwest Diversion, the Gwynns Falls relief sewer and various other projects in the Patapsco service area, and

Whereas, the State of Maryland, Department of Health and Mental Hygiene, has certain powers, duties and responsibilities, with regard to sewage collection, treatment, and disposal and are vested in and imposed upon the Secretary of Health by the provisions of Title 9 of the Health-Environmental Article, and more specifically, but not limited to Subtitles 2, 3, and 5, and the subsections as shown in Attachment I, and

Whereas, the Mayor and City Council of Baltimore owns, operates, and is responsible for the Patapsco Wastewater Treatment Plant and those portions of the Patapsco sewage conveyance system within the political boundaries of Baltimore City, and

Whereas, Baltimore County owns, operates, and is responsible for a sewage conveyance system, part of which is physically connected to the Baltimore City Patapsco conveyance system, and

Whereas, Howard County owns, operates, and is responsible for a sewage conveyance system of which portions are physically connected to the Baltimore County Patapsco Interceptor, and

Whereas, Anne Arundel County owns, operates, and is responsible for a sewage conveyance system of which portions are physically connected to the Baltimore City Patapsco system and portions are physically connected to the Baltimore County Patapsco Interceptor and portions are physically connected to the Howard County Deep Run Interceptor, and

Whereas, the State of Maryland, State Aviation Administration, owns, operates, and is responsible for a sewage conveyance system that is located in Anne Arundel County and is physically connected to the Baltimore County Patapsco Interceptor, and

Whereas, the Mayor and City Council of Baltimore and Baltimore County have entered into agreements dated December 6, 1945, January 30, 1963, and March 6, 1974, for the purposes of continuing the operation of sewerage systems jointly-used between the City and the Metropolitan District of the County (now Charter Government of Baltimore County), and to establish a method for the computation and payment of costs incurred by the City and

County in connection with the jointly-used sewerage systems, and

Whereas, the Mayor and City Council of Baltimore and the Anne Arundel County Sanitary Commission (now Charter Government of Anne Arundel County) entered into an agreement dated August 14, 1939, and updated August 28, 1963, for the purpose of continuing the operation of the integrated (jointly-used) sewerage systems between the City and the Brooklyn Park Sanitary District and to establish a new method for the computation and payment of costs incurred by the City and the Sanitary Commission (now Charter Government of Anne Arundel County) in connection with the integrated (jointly-used) sewerage system, and

Whereas, Baltimore County and Howard County have entered into agreements dated May 6, 1963, modified February 28, 1964, revised August 2, 1968, updated June 4, 1979, amended May 3, 1982, and further amended June 5, 1982, for the purpose of continuing the use of jointly-used facilities, establishing a method for the computation and payment of costs incurred by Baltimore County and Howard County for the construction of jointly used facilities and for the collection, transmission, and disposal of sewage from Howard County and establishing peak flow limits in certain cases that will be accepted by Baltimore County from Howard County, and

Whereas, Baltimore County and Anne Arundel County have entered into an agreement dated April 21, 1976, and amended October 20, 1981, for the purposes of terminating a previous agreement dated March 13, 1958, continuing the use of jointly-used sewer facilities, establishing a method for the computation and payment of costs incurred for the collection, transmission, and disposal of sewage from Anne Arundel County and establishing peak sewage flow limits that will be accepted by Baltimore County from Anne Arundel County, and

Whereas, Howard County and Anne Arundel County have entered into agreements dated August 28, 1963, June 30, 1970, December 11, 1973, and March 30, 1979, for the purpose of sharing the costs of construction and establishing

Peak design sewage flow for each jurisdiction in a jointly-used sewage conveyance system located in the Deep Run Drainage area, a part of the Patapsco Drainage area, portions lying within Howard County and portions within Anne Arundel County, and

Whereas, Baltimore County is currently negotiating an agreement with the State of Maryland, State Aviation Administration, for the purpose of establishing a method for the computation and payment of costs incurred by Baltimore County for the construction and use of jointly-used facilities for the collection, transmission, and disposal of sewage from the Baltimore and Washington International Airport complex, and

Whereas, the population, industrial, and commercial growth in the Patapsco Sewerage System Service area created a need for the expansion of sewage conveyance and treatment facilities, and

Whereas, the expanded sewerage facilities are necessary to adequately convey and treat sewage to protect the public health, safety, comfort, and water quality, and

Whereas, the Patapsco Wastewater Treatment Plant has encountered problems during the start-up of those new components intended to expand and upgrade the Plant to its 70 mgd design capacity, and

Whereas, the Baltimore City Gwynns Falls Relief sewer is under construction, and

Whereas, the aforementioned operational problems have caused the need for allocations and to limit sewage flows into the Patapsco sewerage service area, and

Whereas, the purpose of this Memorandum of Understanding is to establish an allocation figure for each jurisdiction benefiting from the 70 mgd Patapsco Wastewater Treatment Plant and to further establish the conditions governing these flow allocations, flow diversions, and flow monitoring, in the Patapsco Sewerage Service areas:

NOW, THEREFORE, THIS MEMORANDUM OF UNDERSTANDING WITNESSETH, that in consideration of the mutual benefits to each of the parties hereto it is hereby agreed as follows:

Item 1 -- The following words shall have the meaning indicated

Total design treatment capacity (TDTC) -- for the purposes of this Memorandum of Understanding is 70 mgd average daily flow.

Allowable operational capacity (AOC) -- The amount of sewage capacity as determined and set by the OEP that can be safely and lawfully processed and discharged by the Patapsco Wastewater Treatment Plant.

Useable capacity (UC) -- The portion of the allowable operational capacity that can be used by a jurisdiction.

Office of Environmental Programs (OEP)

Item 2 -- The previous Memorandum of Understanding dated May 4, 1978, and revised June 16, 1978, is no longer in effect.

Item 3 -- Each jurisdiction is allowed the following portion of the total design treatment capacity of 70 mgd at the Patapsco Wastewater Treatment Plant:

Baltimore City	19.6 mgd
Baltimore County	34.7 mgd
Howard County	10.0 mgd
Anne Arundel County	5.7 mgd

The derivation of the above figures is shown in Attachment II.

Item 4 -- The OEP, under the provisions of Title 9, Health-Environmental Article of the Annotated Code of Maryland, shall establish the allowable operational capacity of the Patapsco Wastewater Treatment Plant insofar as its ability to adequately treat sewage in a manner to protect the public health, safety, comfort, and water quality. The OEP in determining allowable operational capacity will consider, but is not limited to such factors as design capacity, the quantity and quality of existing sewage flows,

compliance with an NPDES discharge permit including any schedules of compliance, adherence to or any deviation from any schedules of proposed construction projects, adequacy of maintenance of a facility, adequacy of operation, reliability of a particular facility, history of operation, any water quality impacts, any public health impacts, and any other factor OEP considers appropriate in determining an allowable operational capacity.

The OEP will establish or set increases or decreases in the allowable operational capacity of Patapsco Wastewater Treatment Plant or declare a moratorium according to the following procedure:

A. The OEP will first notify by letter the Patapsco Task Force Committee, which consists of the directors of public works or the director of utilities or their designees, of any proposed increase or decrease in the allowable operational capacity or need for a moratorium at the Patapsco Wastewater Treatment Plant. In cases where the allowable operational capacity is proposed to be increased or decreased, the notice shall also show proposed new usable capacities for each jurisdiction. These proposed new usable capacities will be obtained by using the following formulas:

1. Increases in allowable operational capacity for each jurisdiction.

a. portion of TDTC - existing UC

$$\% \text{ increase of UC} = \frac{\text{TDTC} - \text{existing AOC}}{\text{existing UC}}$$

b. new UC = existing UC + (% increase in UC) x (increase in AOC)

2. Decreases in allowable operational capacity for each jurisdiction.

a. existing UC - actual flows from user

$$\% \text{ decrease of UC} = \frac{\text{existing UC} - \text{actual flow at WWTP}}{\text{existing UC}}$$

b. new UC = existing UC - (% decrease in UC) x (decrease in AOC)

3. Where problems with physical plant management or waste characteristics result in a Consent Agreement with the State Health Department, failure of a jurisdiction or jurisdictions to meet

compliance deadlines agreed to in the Consent Agreement may result in a reduction or loss of that jurisdiction's or jurisdictions' allocation.

B. The Patapsco Task Force Committee will be given 30 days from the notice date to revise the proposed new usable capacities as shown in the notice. The OEP will accept and recognize any revisions to the proposed new usable capacities provided that:

1. the total of the revised usable capacities do not exceed the proposed allowable operational capacity.
2. each jurisdiction agrees in writing to the revised new usable capacities.
3. OEP is provided a copy of the signed document.
4. It should be understood that the formula for distribution of each jurisdiction's usable capacity is for the period of time during which the Patapsco Wastewater Treatment Plant's allowable operational capacity is less than the total design treatment capacity and thereafter limits on each jurisdiction's allocation will be based on their portion of total plant capacity.

In the case where the OEP has indicated that a moratorium is necessary, the Patapsco Task Force Committee shall be given the opportunity to correct the problem or by signature of all the jurisdictions formulate a proposed solution that will alleviate the need for a moratorium.

C. If after 30 days the Patapsco Task Force Committee fails to revise the proposed new usable capacities or formulate an acceptable proposal to alleviate the need for a moratorium, the proposed new usable capacities as shown in the original notice, or moratorium shall automatically become effective.

Item 5 -- Each jurisdiction will not allocate or take any action that will cause the usable capacity it is allowed to be exceeded and will take all necessary actions, that are proper and legal, to prevent the usable capacity figure from being exceeded.

Item 6 -- This Memorandum of Understanding shall not be used as a basis

Patapsco Wastewater Treatment Plant and shall not amend, add to, delete from or supersede or stand in the place of any existing contractual agreements; however, Howard County's cost participation through Baltimore County shall be adjusted to reflect the decrease of the purchased design capacity through Baltimore County from 10.332 mgd average daily flow to 10.000 mgd average daily flow.

Item 7 -- The proportional figures for each jurisdiction set out in item 3 are valid until the Patapsco Wastewater Treatment Plant total design treatment capacity of 70 mgd is increased by the Office of Environmental Programs.

Item 8 -- Revised proportional figures for each jurisdiction shall be established prior to any future expansion, addition, or allowable capacity rating that increases the total design treatment capacity of the Patapsco Wastewater Treatment Plant above or greater than 70 mgd.

Item 9 -- The proportional figures for each jurisdiction set out in item 3 may or may not be fully utilized by one or more jurisdictions due to physical capacity limits of the Patapsco sewage collection and conveyance system or agreed to capacity limits between jurisdictions as set forth in the above-mentioned agreements.

Item 10 -- Baltimore City (Mayor and City Council of Baltimore) shall, with all urgency, take all practical steps and actions within their means to operate and improve the Patapsco Wastewater Treatment Plant to achieve compliance with the NPDES discharge permit.

Item 11 -- The current allowable operational capacity of the Patapsco Wastewater Treatment Plant is 39.795. This allowable operational capacity of 39.795 mgd includes existing 1983 Annual Average Flows of 36.9 mgd and 2.895 mgd which may be used immediately by the user jurisdictions as shown in Attachment III.

Item 12 -- Each jurisdiction shall provide a sewage flow monitoring program. This flow monitoring program will establish, with all practical precision, the

annual average daily amount of sewage flow each jurisdiction is contributing to the Patapsco Sewerage System. The flow monitoring program will be based on actual sewage flow measurements and may be supplemented with water consumption or water meter records. Each jurisdiction will take steps to insure that sewage flow meters are working, calibrated and located or placed at points within the system to allow the determination of the amount of sewage flow each jurisdiction is contributing to the Patapsco Sewerage System. In the event a flow meter is malfunctioning or not present, the best information available at the time will be used.

Item 13 — Each jurisdiction will establish an allocation program to track and account for all sewage allocations granted, given, or associated with future sewage flows in the Patapsco Service Area. This flow allocation program is intended to provide a mechanism by which each jurisdiction and the OEP can show compliance with Title 9, Subtitle 9-512, and not exceed its useable capacity. Each jurisdiction's allocation program will consider and address the following elements:

- A. The jurisdictions useable capacity.
- B. Conveyance system capacity and limitations.
- C. The allowable operational capacity established by OEP.
- D. The actual sewage flows as provided from the sewage flow monitoring program.
- E. Increases in sewerage system flows as a result of "wet years" also decreases in sewerage system average flows as a result of repairs or modifications to the sewage conveyance system.
- F. Previously-approved projects.
- G. Subdivision plats.
- H. Building permits.

- I. Connection permits.
- J. New Federal, State, or local government facilities that will generate sewage flows.
- K. Failing onsite sewage disposal systems that will be required to connect to the Patapsco Sewerage System.
- L. Any activity or proposal that will, when completed, generate sewage flows into the Patapsco Sewerage Service Area.

Item 14 -- Each jurisdiction shall develop reports of both their flow monitoring program and their allocation program at least annually. The flow monitoring report will be based on measured or estimated annual average daily flows, and shall contain measured or estimated peak flows. Four copies of these reports will be submitted to OEP who will act as a clearinghouse and distribute the copies of these reports to each jurisdiction. The date for submitting these reports shall be determined by the OEP.

Item 15 -- Baltimore City will not divert flows from the Gwynns Falls (High Level system currently going to Back River WWTP) and/or the Maidens Choice Run System (currently going to Back River WWTP) to the Southwest Diversion, which flows to the Patapsco WWTP, until:

- A. The portions of sanitary contract 628 are constructed and operational that provide the facilities needed in order to control the amount of flow going to the Back River Wastewater Treatment Plant.
- B. Accurate and up-to-date flow measurements of the flow going to high level system to be diverted and the existing flow going to the Southwest Diversion have been provided.

- C. All parties to this Memorandum of Understanding have been notified in writing by Baltimore City at least 30 days prior to the actual diversion and the flow amounts stated in B will have been included with the notice; and
- D. Baltimore City and Baltimore County have obtained sufficient useable capacities to allow the diversions, without exceeding their respective useable capacities.

Item 16 -- Howard County will not activate the Route 108 pump station or cease operation of the Deep Run Interim Sewage Treatment Plant, until:

- A. Howard County has obtained sufficient useable capacity to allow the diversion, without exceeding its useable capacity;
- B. Accurate and up-to-date measurements of the flows to be immediately or initially added to the Patapsco sewerage system by the start of operation of the Route 108 pump station and/or the diversion of flows from the Deep Run Interim Sewage Treatment Plant into the Patapsco sewerage system have been provided; and
- C. All parties to this Memorandum of Understanding have been notified in writing by Howard County at least 30 days prior to the actual addition of flows into the Patapsco Sewerage System, and flow amounts as stated in b) have been included with the notice.

Item 17 -- This Memorandum of Understanding will be reviewed at least annually, but may be reviewed any time, and any changes, revisions, or modifications may be proposed by any party, at any time, and may become incorporated into this Memorandum of Understanding according to the following procedure:

- A. A draft in writing of the proposed changes, revisions, or modifications must be sent to all parties.
- B. A meeting must be held so that all parties may have the opportunity to discuss the proposed changes, revisions, or modifications. At least 30 days written notice must be given to all parties prior to the meeting.
- C. Once the proposed changes, revisions, or modifications are agreed to in writing by all parties, then the changes, revisions, or modifications will become part of this Memorandum of Understanding.

Item 18 -- All parties of this Memorandum of Understanding realize and understand that this Memorandum of Understanding shall in no way relieve the City of Baltimore, Baltimore County, Anne Arundel County, or Howard County of any obligations to comply with any State or Federal laws, nor does this Memorandum of Understanding in any way abrogate or limit any other requirements which may now exist or hereafter be imposed by the State or the Environmental Protection Agency pursuant to conditions or requirements made a part of a grant relevant to the construction of sewage treatment works. This includes the requirement that Baltimore City and Baltimore County enter into a new service agreement as required by the step 3 grant condition of the Gwynns Falls relief interceptor.

Item 19 -- All parties agree and understand that this Memorandum of Understanding shall in no way affect the powers and duties of the Secretary including the exercise of any authority to protect the public health, safety, or comfort, or the waters of the State.

Item 20 -- All parties to this Memorandum of Understanding shall have the right to appeal any action taken by the Secretary of Health pursuant to the establishment of the allowable operating capacity of the Patapsco Wastewater Treatment Plant.

Item 21 -- In the event of any disagreement between the user jurisdictions' signatory to this Memorandum of Understanding over the terms of the Memorandum of Understanding, the user jurisdictions shall submit, on the demand of either, the matter to arbitration in the following manner: The First Party shall appoint one arbitrator, and the Second Party shall appoint one arbitrator. The two arbitrators so appointed shall select a third, who shall be chairman of the board of arbitration. If the two arbitrators are unable to agree upon the third arbitrator, the Secretary of Health and Mental Hygiene of the State of Maryland shall be requested to designate such third arbitrator; and the written decision of the majority of the board of arbitration shall be final and binding upon both Parties.

SIGNATORIES

State of Maryland

William M. Eichbaum 6/4/84
Date
Assistant Secretary for
Environmental Programs

Approved as to form
and legal sufficiency

Marc K. Col

Richard B. Sellars Jr. 5/21/84
Date
Director
Water Management Administration

Baltimore City

MAYOR AND CITY COUNCIL OF BALTIMORE

[Signature]
Custodian of City Seal

Approved as to form and legal sufficiency

William Donald Schaefer
Date
Mayor, City of Baltimore

[Signature]
Assistant City Solicitor

APPROVED:

Approved by the Board of Estimates
this day of 1984

Francis W. Kuchta 5/13/84
Date
Director
Department of Public Works
City of Baltimore

Richard A. Lidinsky
Deputy Comptroller
and Clerk to the Board of Estimates

Baltimore County

Donald P. Hutchinson 5/22/84
Date
County Executive
Baltimore County

Approved as to form
and legal sufficiency

William F. [Signature] 5/22/84

Harry J. Pissel 5/21/84
Date
Director
Department of Public Works
Baltimore County

SIGNATORIES/2

Anne Arundel County

Approved as to form and
legal sufficiency

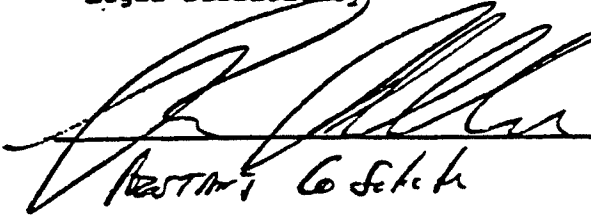

William C. Schick 5/23/84

for 

James Lighthizer 5/23/84
County Executive
Anne Arundel County Date



Thomas Neel, Director 5/23/84
Department of Utilities Date
Anne Arundel County

Howard County

Approved as to form and
legal sufficiency

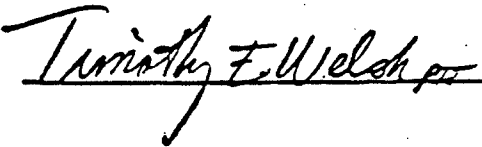

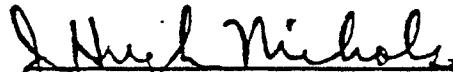

J. Hugh Nichols 5-18-84
County Executive Date
Howard County

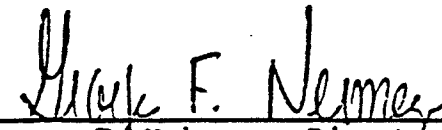

George F. Neimeyer, Director 5-18-84
Department of Public Works Date
Howard County

ATTACHMENT I

Relative Subtitles and Sections of Title 9

Subtitle 2 - Regulation by State

- Section 9-204 - Powers and Duties of Secretary
- Section 9-207 - Order by Secretary when operation inefficient; action by Secretary if results not produced.
- Section 9-208 - Order for alterations or extensions when Department finds improvements cannot be made by change of manner of operation; powers of local health officer
- Section 9-209 - Installation of system if Secretary finds conditions dangerous to health
- Section 9-210 - Permits required to install, alter, or extend system or handle, burn, or store sewage sludge; landfills near hospitals; landfills for hazardous wastes.
- Section 9-225 - Civil Penalty
- Section 9-228 - Secretary Designated as State Water Pollution Control Agency.

Subtitle 3 - Water Pollution Control

- Part III - Powers and Duties of Department
- Part V - Enforcement

Subtitle 5 - County Plans

- Section 9-505 - Rules and Regulations of the Department
- Section 9-512 - Conformance to Approved Plans Required

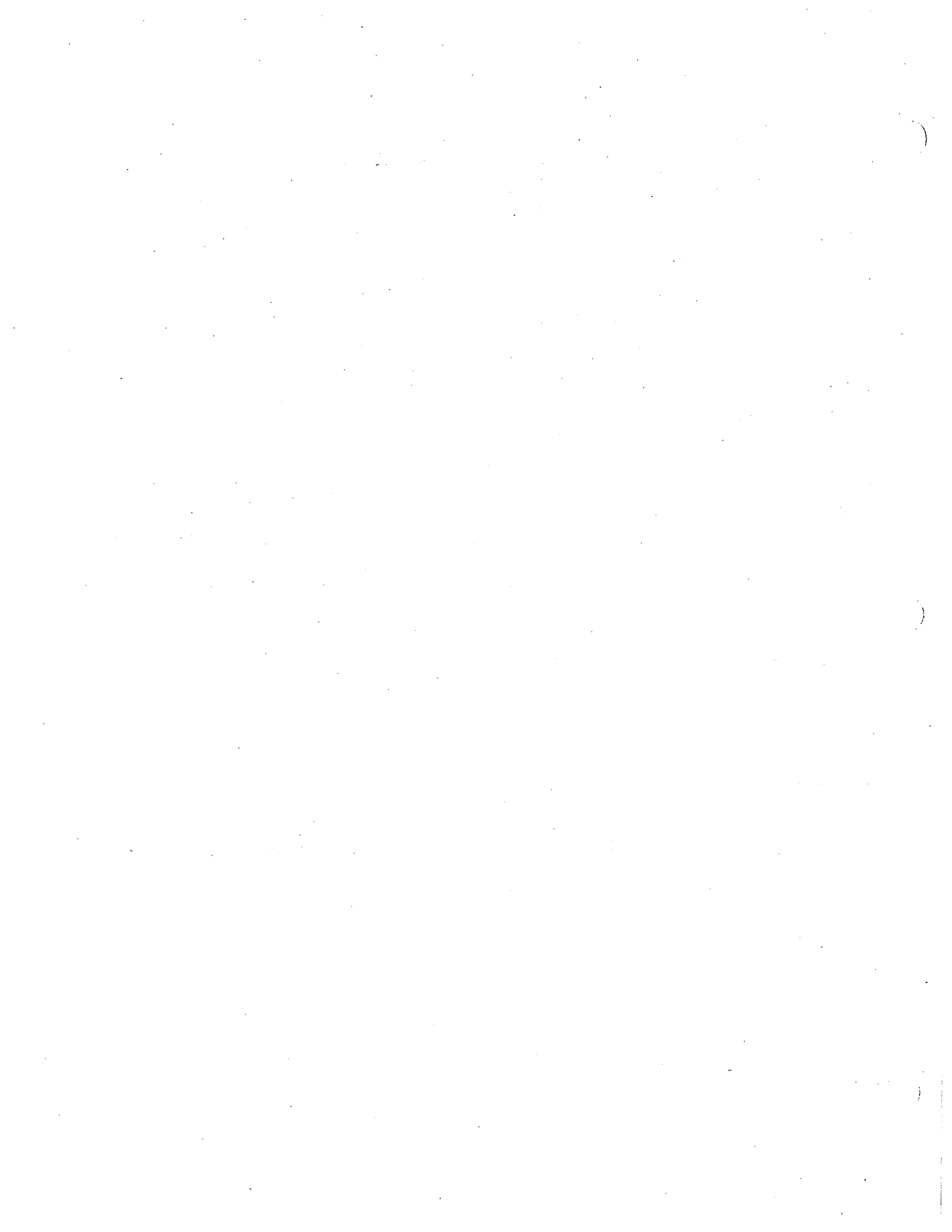

Memorandum of Understanding

Attachment II

Derivation of Each Jurisdiction's Portion of the 70 mgd Design
Treatment Capacity

Each jurisdiction's portion of the 70 mgd design treatment capacity is partially based on a percentage of the total cost or local share each jurisdiction was charged for or contributed to directly or indirectly for the three 70 mgd design capacity components of the treatment plant expansion. The allowance figure obtained by the percentage of the costs or contribution is then adjusted to reflect the direct flows from Anne Arundel County to Baltimore City.

The cost figures used in determining the percentage figure for each jurisdiction were obtained from a "Local Share Cost" table prepared by Baltimore County and dated December 13, 1979.

The steps used to obtain each jurisdiction's portion of the TDTC figures are explained below and are supplemental to the "Table for Derivation of Portion of TDTC."

A. The three 70 mgd design capacity elements are:

1. Secondary Treatment Facilities.
2. Sludge Processing Facilities, etc.

Note: The costs shown on this line include the sludge processing facilities that were built on the basis of 70 mgd and the Administration and Maintenance Building, which were built on the basis of 210 mgd. This inclusion is recognized and accepted.

3. Sludge Thickeners and Power Facilities.

Note: The costs for this line include the sludge thickeners which were built on the basis of 70 mgd and the power facilities that were built on the basis of 210 mgd. This inclusion is recognized and accepted.

- B. Each of the jurisdictions total cost or contribution for the three elements in A was obtained.
- C. The total local cost for the three elements in A was obtained.
- D. A percentage figure for each jurisdiction was obtained by dividing each jurisdiction's total cost or contribution for the three elements (B) by the total local costs (C).
- E. The percentage figure obtained (D) was then multiplied by 70 to obtain the initial portion.
- F. The initial portion figure (E) was then adjusted to account for the 1 mgd flow Anne Arundel County is contributing directly to Baltimore City.

TABLE FO. ALLOCATION OF EACH JURISDICTION'S PROPORTION OF D.C.

	Baltimore City	Baltimore County	Howard County	Anne Arundel County	Totals
Secondary Treatment					
Cost/Contribution -	1,345,200	2,224,500	611,200	333,200	4,514,100
% of element -	29.8	49.3	13.5	7.4	100
mgd of element -	20.06	34.51	9.45	5.18	70
Sludge Processing, etc.					
Cost/Contribution -	652,600	1,219,300	409,200	147,700	2,428,800
% of element -	26.9	50.2	16.8	6.1	100
mgd of element	18.83	35.14	11.76	4.27	70
Sludge Thickeners					
Power Facilities -					
Cost/Contribution -	167,800	340,900	101,400	48,100	658,200
% of element -	25.5	51.8	15.4	7.3	100
mgd of element -	17.85	36.26	10.78	5.11	70
Total Cost/Contribution for 3 elements -					
	2,165,600	3,784,700	1,121,800	529,000	7,601,100
Cost of 3 elements -					
	7,601,100	7,601,100	7,601,100	7,601,100	7,601,100
Initial					
	28.49	49.79	14.76	6.96	100.0
	X 70	X 70	X 70	X 70	
	19.943	34.853	10.332	4.872	70
May 8, 1984 adjustments					
	19.6	34.7	10.0	5.7	70

to each jurisdiction's portion of T.D.T.C. as agreed to by all parties to this Memorandum of Understanding



Available Operational Capacity of the Patuxent Wastewater Treatment Plant and Usable Capacities for Each Jurisdiction as of the Date of this Memorandum

	Baltimore City	Baltimore County	Howard County	Anne Arundel County	Totals
Whitman & Requardt Flow Monitoring Report 1981 early 1982)	SWD 2.7 direct 6.5 <u>9.2</u>	SWD 5.6 P.P.S. 9.9 DWI <u>1.7</u> 16.2	P.P.S. 1.7 <u>1.7</u> .370	P.P.S. 1.9 direct 1.3 <u>3.2</u> .697	<u>30.3</u> 6.6
Proportional Increase in Flows since Whitman Report (See Note A)	2.004	3.529			
1983 Annual Average Flow (Measured at the WWTP)	11.204	19.729	2.070	3.897	36.9
Remaining 1983 Usable Capacities to be Intro- duced into the Sewerage System (See Note B)	0.385	0.420	0.420	0.420	1.645
Existing Usable Capacity Existing Flows & 1983 Remaining Usable Capacities	11.589	20.149	2.490	4.317	Existing AOC 38.545
March 1984 Increase in Usable Capacities Using Memorandum Formula (See Note C)	.255	.462	.239	.044	Increase in AOC + 1.25
		<u>.250</u> .489			
Total Usable Capacities	11.844	20.611	2.979	4.361	Total Allowable Operational Capacity 39.795

*Special one time allocation of 250,000 gallons to Howard County not subject to formula.



Note A - Flow distributions were developed by using the Whitman and Requardt 1981 and early 1982 flow monitoring data and proportioning the 6.6 mgd increase in 1983 and average flows at the Patapsco Wastewater Treatment Plant to each jurisdiction. This method was used since actual meter data for all the jurisdictions' flow contributions was not available. The calculations are shown below.

Baltimore City
 $\frac{9.2}{30.3} \times 6.6 = 2.004$

Baltimore County
 $\frac{16.2}{30.3} \times 6.6 = 3.529$

Howard County
 $\frac{1.7}{30.3} \times 6.6 = 0.370$

Anne Arundel County
 $\frac{3.2}{30.3} \times 6.6 = 0.697$

Note B - During 1983 the Office of Environmental Programs granted increases in the usable capacity for each jurisdiction. Some of this capacity has been used and is included in 1983 Annual Average flow of 36.9 mgd. For the purposes of computing the unused portion of these increases, it is assumed that 30% of the increase is reflected in the 1983 Annual Average Flow of 36.9 mgd or 70% of the increases has not yet been used and each jurisdiction is entitled to this capacity.

	<u>Balto. City</u>	<u>Balto. Co.</u>	<u>Howard Co.</u>	<u>A.A. Co.</u>	<u>Total</u>
OEP letter May 11, 1983	None	0.050	0.050	0.050	0.150
OEP letter May 27, 1983	0.050	0.050	0.050	0.050	0.200
Balto. City letter June 15, 1983	<u>0.500</u>	<u>0.500</u>	<u>0.500</u>	<u>0.500</u>	<u>2.000</u>
	0.550	0.600	0.600	0.600	2.35
	<u>X .70</u>	<u>X .70</u>	<u>X .70</u>	<u>X .70</u>	<u>X .70</u>
Unused Capacity	0.385	0.420	0.420	0.420	1.645

Note C - Increases in usable capacities using the Memorandum Formula.

A) Formula $\% \text{ increase of U.C.} = \frac{\text{Portion of TDTC} - \text{existing U.C.}}{\text{TDTC} - \text{existing AOC}}$

New U.C. = existing U.C. + $\{(\% \text{ increase of U.C.}) \times (\text{increase in AOC})\}$

B) Known variables:

Jurisdiction	Portion of TDTC	Existing U.C.
Balto. City	19.6	11.589
Balto. Co.	34.7	20.149
Howard Co.	10.0	2.490
A.A. Co.	5.7	4.317

TDTC = 70
 Existing AOC = 38.545
 Increase in AOC = 1.000

C) Calculation

Baltimore City $\% \text{ increase in U.C.} = \frac{19.6 - 11.589}{70 - 38.545} = \frac{8.011}{31.455} = .255$

New U.C. = 11.589 + (.255 X 1)

New U.C. = 11.844

Baltimore County $\% \text{ increase in U.C.} = \frac{34.7 - 20.149}{70 - 38.545} = \frac{14.551}{31.455} = 0.462$

New U.C. = 20.149 + (0.462 X 1)

New U.C. = 20.611

Howard County $\% \text{ increase in U.C.} = \frac{10.0 - 2.490}{70 - 38.545} = \frac{7.51}{31.455} = .239$

New U.C. = 2.490 + (0.239 X 1)

New U.C. = 2.729

Anne Arundel County $\% \text{ increase in U.C.} = \frac{5.7 - 4.317}{70 - 38.545} = \frac{1.383}{31.455} = 0.044$

New U.C. = 4.317 + (0.044 X 1)

New U.C. = 4.361

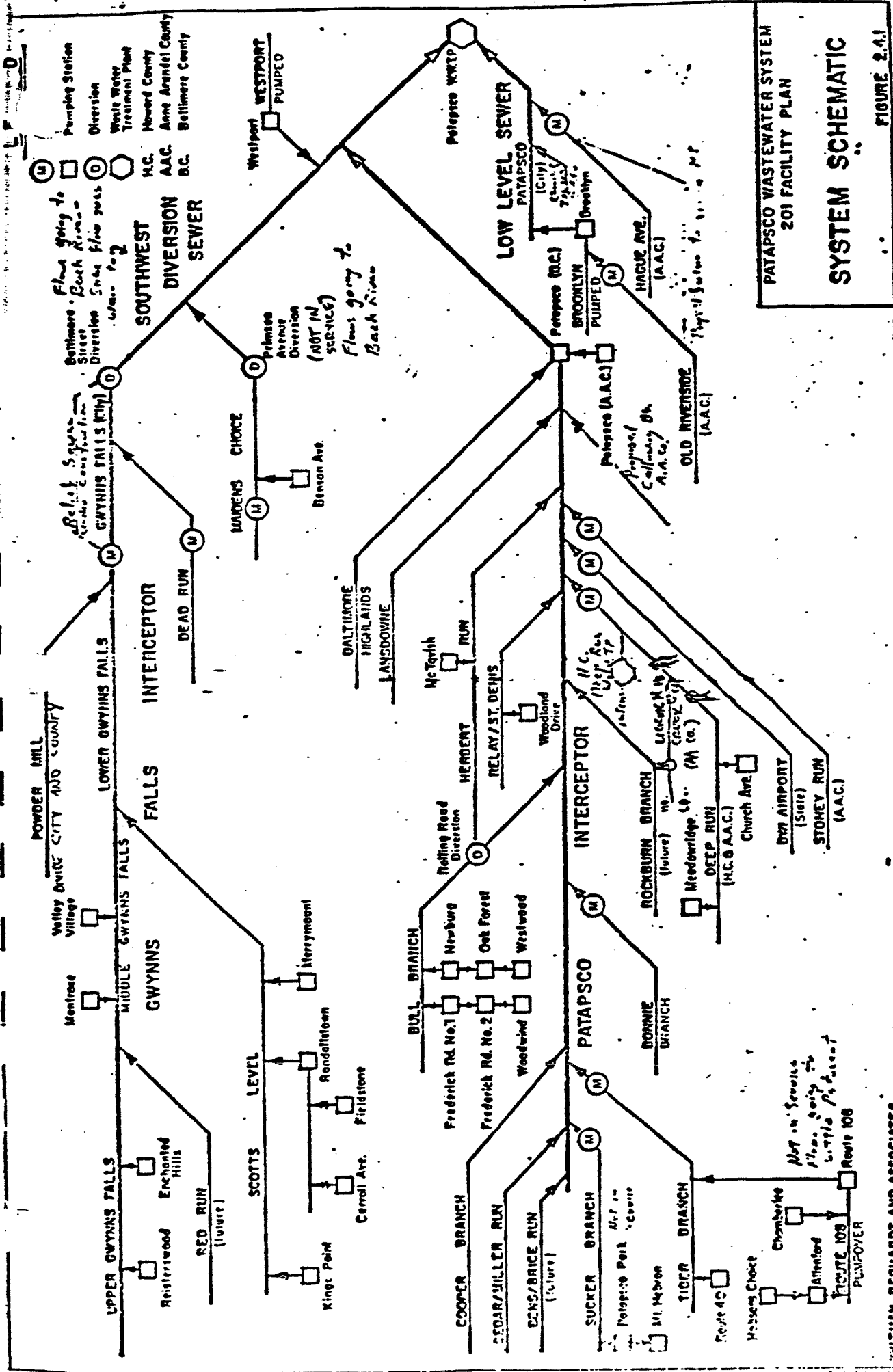

PATAPSCO WASTEWATER SYSTEM
201 FACILITY PLAN
SYSTEM SCHEMATIC
FIGURE 2.4.1

Attachment 2D

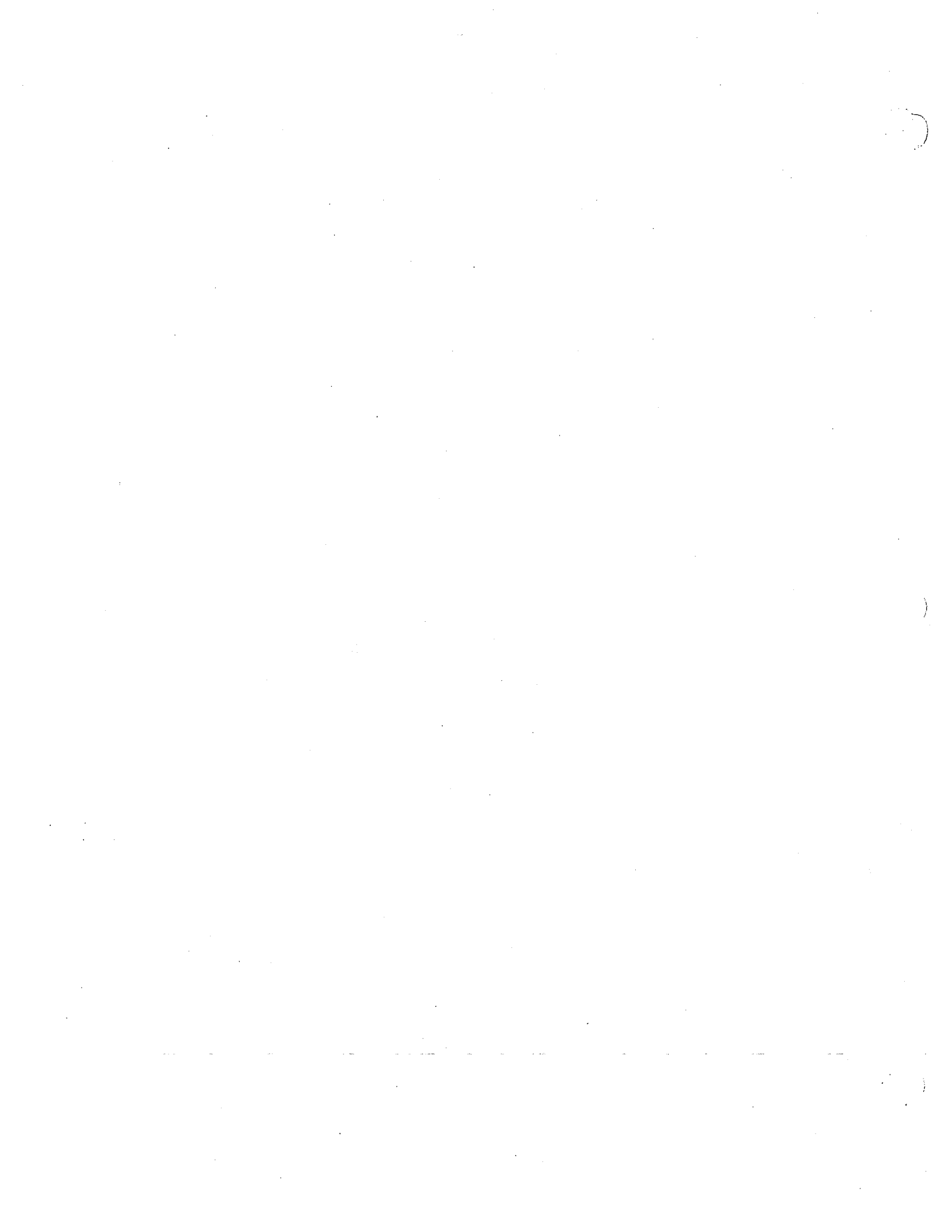

EXHIBIT 9

**LPWRP
NPDES Discharge Permit**

cc. Steve



MARYLAND DEPARTMENT OF THE ENVIRONMENT

1800 Washington Boulevard • Baltimore MD 21230
410-537-3000 • 1-800-633-6101 • www.mde.maryland.gov

Martin O'Malley
Governor

Robert M. Summers, Ph.D.
Secretary

Anthony G. Brown
Lieutenant Governor

SEP - 2 2014

2014 SEP 12 PM 12:00
RECEIVED
DEPT. OF PUBLIC WORKS
DIRECTOR'S OFFICE

CERTIFIED MAIL

Mr. James M. Irvin, Director
Howard County Dept. of Public Works
3430 Court House Drive
Ellicott City, Maryland 21043

RE: Discharge Permit for the Little Patuxent Water Reclamation Plant
State Discharge Permit 13-DP-1421, NPDES Permit MD0055174

Dear Mr. Irvin:

Enclosed is the above discharge permit with the effective date indicated on the cover page. The permittee is responsible for complying with all permit conditions. You are therefore advised to read the permit carefully and become thoroughly familiar with the requirements in order to maintain compliance with the permit.

Attached please find a copy of blank and sample forms for your use to calculate monthly load, year-to-date cumulative load and annual maximum load for Total Nitrogen, Total Phosphorus and Total Suspended Solids (TSS). At the end of each calendar year, the permittee will be required to fill out and submit this form along with the Discharge Monitoring Report (DMR) for the month of December. You may contact the Project Manager to obtain this form in an electronic version (EXCEL SPREADSHEET). In conjunction with the State's conversion to Watershed-based Permitting, the reapplication due date for this permit renewal will be 04/01/2017, unless the Department has granted permission for a later date.

Also enclosed are Discharge Monitoring Report Forms (EPA No. 3320-1), which must be completed for each reporting period and submitted (or electronically submitted through NetDMR) to the Department in accordance with the requirements of the permit. Please direct all future correspondence regarding permit compliance, unless directed otherwise by the discharge permit, to the following address:

Page- 2
Mr. Irvin

Attention: Discharge Monitoring Reports
WMA - Compliance Program
Maryland Department of the Environment
1800 Washington Boulevard, STE 425
Baltimore, MD 21230-1708

You will also find enclosed a copy of the Code of Federal Regulations, Part 136 - "Guidelines Establishing Test Procedures for Analysis of Pollutants". The most current version of 40 CFR, Part 136 can be found online at U.S Government Printing Office (GPO) website. The link is: http://bit.ly/40CFR_Part136 (This link is case-sensitive). Unless otherwise specified, these guidelines are to be used for the analyses required by this permit.

In addition, we enclosed a copy of the table of the Minimum Monitoring Requirements, a copy of Department's "Toxic Pollutant Monitoring Protocol and Reporting Requirements for Toxic Chemical Testing Analytical Data (amended on 05/18/2011)" and a copy of the WWTP Effluent Toxic Chemical Monitoring Data Transmittal Cover Sheet.

If you have any questions, please contact Chris Okoye, Project Engineer, Surface Discharge Permits Division, at (410) 537-3677.

Sincerely,

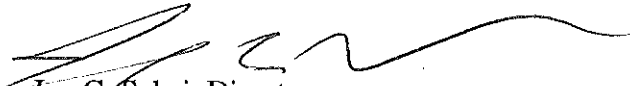

Jay G. Sakai, Director
Water Management Administration

Enclosures

cc: Mr. Mark Smith, U.S. Environmental Protection Agency
Mr. Bert Nixon, Director, Howard County Health Department
Mr. Dave Lyons
Ms. Cindy Harris (Permit cover page only)
Mr. Bill Lee (with a copy of Summary Report & Fact Sheet)
Mr. Donald Currey, SSA
Mr. Dennis Rasmussen



MARYLAND DEPARTMENT OF THE ENVIRONMENT

1800 Washington Boulevard • Baltimore MD 21230
410-537-3000 • 1-800-633-6101 • www.mde.maryland.gov

Martin O'Malley
Governor

Robert M. Summers, Ph.D.
Secretary

Anthony G. Brown
Lieutenant Governor

DISCHARGE PERMIT

NPDES Discharge Permit Number: MD0055174	State Discharge Permit Number: 13-DP-1421
Effective Date: 10/01/2014	Expiration Date: 09/30/2019
Modification Date: (Not applicable)	Reapplication Due Date: 04/01/2017

Pursuant to the provisions of Title 9 of the Environment Article, Annotated Code of Maryland, and regulations promulgated thereunder, and the provisions of the Clean Water Act, 33 U.S.C. Section 1251 et seq., and implementing regulations 40 CFR Parts 122, 123, 124 and 125, the Department of the Environment hereby establishes conditions and requirements pertinent to the wastewater treatment plant and collection system and authorizes:

Howard County Department of Public Works
3430 Court House Drive
Ellicott City, Maryland 21043

TO DISCHARGE FROM: Little Patuxent Water Reclamation Plant

LOCATED AT: 8900 Greenwood Place
Savage, Howard County, Maryland 20763

THROUGH OUTFALL: 001 (WWTP Effluent)
102 (Re-claimed water pumping station)

TO: the Little Patuxent River which is Use-IP designated waters protected for water contact recreation and nontidal warmwater aquatic life, and to the Federal Reclaim Water Cooling System at the discharge point 102; in accordance with the following special and general conditions and a map incorporated herein and made a part hereof. |

I. DEFINITIONS

- A. "Ambient temperature" of the effluent receiving stream means the water temperature that is not impacted by a point source discharge, and it shall be measured in areas of the stream representative of typical or average conditions of the stream segment in question.
- B. "Bypass" means the intentional diversion of pollutants from any portion of a treatment or collection facility.
- C. "BOD₅ (Biochemical Oxygen Demand)" means the amount of oxygen consumed in a standard BOD₅ test without the use of a nitrification inhibitor at 20 degree centigrade on an unfiltered sample.
- D. "Clean Water Act" means the Federal Water Pollution Control Act, as amended, 33 U.S.C. Section 1251 *et seq.*
- E. "CFR" means the Code of Federal Regulations.
- F. "COMAR" means the Code of Maryland Regulations.
- G. "Department" means the Maryland Department of the Environment (MDE).
- H. Discharge Limits
1. "Daily *maximum* or (*minimum*)" limitation means the *highest* (or *lowest*) allowable daily discharge in a calendar month. The daily discharge expressed as concentration (in mg/l) shall be calculated by dividing the total of measurement readings by the number of samples collected during a calendar day or any 24-hour period that reasonably represents the calendar day for purposes of sampling. The daily discharge expressed as loading rate of a parameter (in pounds/day) is calculated by using this formula: {daily average concentration (mg/l) x the same day total flow (in million gallons) x 8.34}.
 2. "Weekly average (*maximum* or *minimum*)" limitation means the *highest* or *lowest* allowable average of "daily discharges" over a calendar week, calculated as the sum of all "daily discharges" measured during a calendar week divided by the number of "daily discharges" measured during that week. Each of the following 7-day periods is defined as a calendar week: Week 1 is Days 1 - 7 of the month; Week 2 is Days 8 - 14; Week 3 is Days 15 - 21; and Week 4 is Days 22 - 28. *For weekly average maximum*, if the "daily discharge" on days 29, 30 or 31 exceeds the "weekly average" discharge limitation, MDE may elect to evaluate the last 7 days of the month as Week 4 instead of Days 22 - 28. *For weekly average minimum*, if the "daily discharge" on days 29, 30 or 31 is lower than the "weekly average" discharge limitation, MDE may elect to evaluate the last 7 days of the month as Week 4 instead of Days 22 - 28.

I. DEFINITIONS

3. “Monthly average *maximum* (or *minimum*)” limitation means the *highest* (or *lowest*) allowable monthly average concentration or waste load of a parameter over a calendar month. The monthly average is calculated as the sum of all daily discharges for a parameter sampled and/or measured in that calendar month divided by the number of days on which monitoring was performed.
4. “Credit load (CL)” means the total nitrogen load reduction credit resulting from connected retired on-site sewage disposal systems (OSDS) expressed as a total monthly loading rate (lbs/month).

See Footnote (10) in Special Condition II.A.2 for the “CL” applicable under this permit

5. (a) “Monthly total loading rate (in pounds/month)” means the total load of a parameter calculated for that calendar month. It is calculated using the formula “{(monthly average concentration in mg/l) x (Total monthly flow in Million Gallons) x 8.34}” only when sampling frequency is less than four days per week, otherwise, it is calculated as the sum of all daily discharge expressed in units of mass divided by the number of days on which monitoring was performed, times the number of days in the month. For any outfall or monitoring point where the required parameter is not monitored for concentration, a specific method of calculation is provided for that outfall in Part II.B of this permit.
- (b) “NET monthly total loading rate (in pounds/month)” means monthly total loading rate of Total Nitrogen calculated for that calendar month as 5(a) above less any onsite septic disposal system credit load (CL) in lbs/month.
6. (a) “Annual Maximum Loading Rate (in pounds/year)” limitation means the highest allowable year-to-date cumulative load of a parameter for a calendar year. It is calculated as the sum of the individual monthly total loading rates from January through the reporting month in a calendar year.
- (b) “Net Annual Maximum Loading Rate (in pounds/year)” limitation means the highest allowable year-to-date (net) cumulative load of a parameter for a calendar year. It is calculated as the sum of the individual “net monthly total loading rates” from January through the reporting month in a calendar year.
7. “Monthly log mean (Monthly geometric mean)” limit means the highest allowable value calculated as the logarithmic or geometric mean of all samples taken in the calendar month. The geometric mean is the antilogarithm of the mean of the logarithms.

I. DEFINITIONS

Discharge Monitoring

8. "Composite sample" means a combination of individual samples obtained at hourly or smaller intervals over a time period. Either the volume of each individual sample is proportional to discharge flow rates or the sampling interval (for constant volume samples) is proportional to the flow rates over the time period used to produce the composite.
 9. "Grab sample" means an individual sample collected over a period of time not exceeding 15 minutes.
 10. "Estimated flow" value means a calculated volume or discharge rate which is based on a technical evaluation of the sources contributing to the discharge including, but not limited to, pump capabilities, water meters, and batch discharge volumes.
 11. "Measured flow" value means any method of liquid volume measurement, the accuracy of which has been previously demonstrated in engineering practice, or for which a relationship to absolute volume has been obtained.
 12. "Recorded flow" means any method of providing a permanent, continuous record of flow including, but not limited to, circular and strip charts.
 13. "Monthly average flow" means the total flow for a calendar month divided by the number of days in the same month.
- I. "i-s (immersion stabilization)" means a calibrated device immersed in the effluent or stream, as applicable, until the temperature reading is stabilized.
- J. "NPDES (National Pollutant Discharge Elimination System)" means the national system for issuing permits as designated by the Clean Water Act.
- K. "Nondetectable Level" for total residual chlorine means a residual concentration of less than 0.10 mg/l as determined using either the DPD titrimetric or chlorimetric method or an alternative method approved by the Department.
- L. "Outfall" means the location where the effluent is discharged into the receiving waters.
- M. "Overflow" means any loss of wastewater or discharge from a sanitary sewer system, combined sewer system or wastewater treatment plant bypass (as defined in I.B) which results in the direct or potential discharge of raw, partially treated wastewater into the waters of the State.
- N. "Permittee" means an individual or organization holding the discharge permit issued by the Department.

I. DEFINITIONS

- O. "POTW" means a publicly owned treatment works.
- P. "Sampling Point" means the effluent sampling location in the outfall line(s) downstream from the last addition point or as otherwise specified.
- Q. "Sanitary Sewer Overflow (SSO)" means a discharge of untreated or partially treated sewage from a separate sewer system before the sanitary wastewater reaches the headworks of a wastewater treatment facility, pursuant to COMAR 26.08.10.01.
- R. "Significant Industrial User (SIU)" is defined as any industrial user (IU) that:
1. is subject to national categorical standards; and
 2. any other IU that:
 - a. discharges an average of 25,000 gallons per day or more of process wastewater (excluding sanitary, non-contact cooling and boiler blowdown wastewater); or
 - b. contributes a process wastestream that makes up 5% or more of the average dry weather hydraulic or organic capacity of the POTW; or
 - c. is designated as such by the POTW on the basis that the IU has a reasonable potential for adversely affecting the POTW's operation or for violating any pretreatment standard or requirement; or
 - d. is found by the POTW, the Department, or the Environmental Protection Agency (EPA) to have significant impact either individually or in combination with other contributing industries to the POTW, on the quality of the sludge, the POTW's effluent quality, or air emissions generated by the system.
- T. "TKN (Total Kjeldahl Nitrogen)" means organic nitrogen plus ammonia nitrogen.
- U. "TSS (Total Suspended Solids)" means the residue retained on the filter by an analysis done in accordance with Standard Methods or other approved methods.
- V. "Upset" means the exceptional incident in which there is unintentional and temporary noncompliance with technology-based permit effluent limitations because of factors beyond the reasonable control of the permittee. An upset does not include noncompliance to the extent caused by operational error, improperly designed treatment facilities, inadequate treatment facilities, lack of preventive maintenance, or careless or improper operation.

II. SPECIAL CONDITIONS

A.1 Effluent Limitations (Nutrient and TSS loads), Monitoring Point 101(Final Effluent Sampling Point) ⁽¹⁾⁽²⁾⁽³⁾⁽⁴⁾⁽⁵⁾⁽⁹⁾

This location includes an annual loading cap for TN, TP and TSS based on the Bay TML and actual flow ⁽⁵⁾. The quality of the effluent from the facility shall be limited at all times as shown below:

Effluent Characteristics	Maximum Effluent Limits			
	Monthly Total Loading Rate (Pounds/ Month)	Net Monthly Total Loading Rate, ⁽¹⁰⁾ (Pounds/Month)	Annual Maximum Loading Rate, ⁽¹⁰⁾ (Pounds/Year)	Net Annual Maximum Loading Rate (Pounds/Year)
Total Phosphorus ⁽⁶⁾⁽⁷⁾⁽⁸⁾	Report	---	23,358	---
Total Nitrogen ⁽⁶⁾⁽⁷⁾⁽⁸⁾	Report	Report	309,715	Report ⁽¹⁵⁾
Total Suspended Solids ⁽⁵⁾	Report	---	2,284,170	---

Effluent Characteristics	Effluent Limits	
	Maximum	Minimum
E. Coli	126 MPN/ 100 ml monthly geometric mean value	N/A
Total Residual Chlorine ⁽¹¹⁾	UV used	N/A
pH	8.5	6.5
Dissolved Oxygen	N/A	5.0 mg/l at anytime 6.0 mg/l daily average.

An annual average flow of 29 million gallons per day (mgd) was used in waste allocation calculations to establish the effluent limitations specified in A.1 and A.2 and this unit should be used when reporting on the Discharge Monitoring Report (DMR), (EPA Form 3320-1, Rev. 01/06). Notification is to be provided to the Department at least 180 days before the annual average flow is expected to exceed this flow level. If a permit modification is required, the Department will initiate the public participation NPDES process.

II. SPECIAL CONDITIONS

A.2 Effluent Limitations, Outfall 001 ⁽¹⁾ ⁽²⁾ ⁽³⁾ ⁽⁴⁾

The quality of the effluent discharged by the facility at Outfall 001 shall be limited at all times as shown below:

Effluent Characteristics	Maximum Effluent Limits			
	Monthly Average Loading Rate, Pounds/day	Weekly Average Loading Rate, Pounds/day	Monthly Average Concentration, mg/l	Weekly Average Concentration, mg
BOD ₅	4/1 to 10/31	1200	5.0	7.5
	11/1 to 3/31	6300	26	39
Total Ammonia				
Nitrogen as N	4/1 to 10/31	180	0.75	1.1
	11/1 to 3/31	1700	7.0	---
Total Suspended Solids (TSS)	6300	9400	26	39

	Monthly Total Loading Rate	Annual Maximum Loading Rate
Total Nitrogen	Report ⁽²⁶⁾	Report
Total Phosphorus	Report ⁽²⁶⁾	Report

An annual average flow of 29 million gallons per day (mgd) was used in waste allocation calculations to establish the effluent limitations specified in A.1 and A.2 above and this unit should be used when reporting on the Discharge Monitoring Report (DMR), (EPA Form 3320-1, Rev. 01/06). Notification is to be provided to the Department at least 180 days before the annual average flow is expected to exceed this flow level. If a permit modification is required, the Department will initiate the public participation NPDES process.

- (1) When this permit is renewed, the new limitations might not be equal to the above limitations.
- (2) There shall be no discharge of floating solids or visible foam other than trace amounts.
- (3) The permit may also be reopened in accordance with the requirements of MDE's Watershed Permitting Plan under which all discharge permits in a watershed are issued the same year.
- (4) The Little Patuxent River is on the 303(d) list as impaired waters for nutrient, sediment, cadmium, and impact to biological communities. Centennial Lake located within the watershed was identified as impaired by nutrients and sediments, and have been addressed by TMDLs approved in 2002. The cadmium listing has been addressed by a Water Quality Analysis submitted in 2008 that showed no impairment. A Total Maximum Daily Load (TMDL), approved by the EPA on 9/30/2011 for nutrient and sediment, and the discharge permit TSS limit is in conformance with this TMDL.

When TMDLs for other remaining parameters are completed, limits may be imposed, after the public participation process, to incorporate any TMDL requirements.

II. SPECIAL CONDITIONS

- (5) This permit is in conformance with the "Chesapeake Bay TMDL for Nitrogen, Phosphorus and Sediment" established on December 29, 2010.
- (6) The Annual Maximum Loading Rate limits of 309,715 lbs/yr total nitrogen, and 23,358 lbs/yr total phosphorus include 5,159 lbs/yr TN and 516 lbs/yr TP WLA loads from the retirement and connection of the MD-VA Milk Producers WWTP (MD 0000469) to the Little Patuxent WRP.
- (7) The permittee shall operate the ENR facility in a manner that optimizes the nutrient removal capability of the facility.
- The first exceedance of the permit limit shall be counted and reported as daily exceedances beginning from the first exceedance, determined to the nearest day, through December 31. In addition, after any such exceedance, the permittee shall demonstrate to the Department's satisfaction that the facility is optimizing its nutrient removal capability, and neither the arrival of the next calendar year nor the issuance of a permit renewal during a period of noncompliance shall obviate continuance of any noncompliance status related to treatment optimization requirements.
- (8) For Outfall 101, at the end of each calendar year the permittee shall comply with the *concentration-based* limitations for the Annual Maximum Loading Rate defined below in addition to the TMDL-based loading rate limitations:
- (a) **TN Limitation (lbs/year):** 4.0 mg/l x annual total flow (calendar year based in million gallons per year) x 8.34 or the combination of total nitrogen waste load allocations specified in Special Condition I.A.1 and Onsite Septic Disposal System (OSDS) credit (see footnote 10), whichever is lower. To the extent that the permittee alleges that temperature levels of 12 degrees C or lower have diminished the treatment system's capability of complying with this *concentration-based* loading rate limitation for Total Nitrogen, the permittee shall provide notification beginning with the calendar year report under the "Upset" provision in Section III.B.6 of this permit. In any enforcement proceeding, the permittee seeking to establish the occurrence of an upset has the burden of proof.
- (b) **TP Limitation (lbs/year):** 0.30 mg/l x annual total flow (calendar year based in million gallons per year) x 8.34 or the total phosphorus waste load allocations specified in Special Condition I.A.1., whichever is lower.
- The details and results of the required annual calculations for the above concentration-based limits shall be submitted to the Department with the Discharge Monitoring Report for December.
- Note:** When the average annual wastewater flow approaches 29 MGD, an annual total nitrogen concentration of 3.5 mg/l and total phosphorus concentration of 0.25 mg/l would be necessary achieve an annual TN load of 309,715 lbs/yr and TP of 23,358 lbs/yr.
- (9) The permittee may request that the permit be reopened and modified to include nutrient trading consistent with the most current "Maryland Policy for Nutrient Cap Management and Trading in Maryland's Chesapeake Bay Watershed" in effect at that time.
- (10) A TN nutrient credit of 80.5 lbs/mon (no more than 966 lbs/year) applies for reporting and compliance purpose, resulting from retiring and connecting onsite sewerage disposal system (OSDS) to the Little Patuxent Water Reclamation Plant (See Special Conditions, footnote (15) and definitions I. H.4, I.H.5(b) and I.H.6(b).
- (11) Total residual chlorine limitation of 0.013 mg/l shall apply only if chlorine or chlorine-containing compound is used in the wastewater treatment. The minimum level (quantification level) for total residual chlorine is 0.10 mg/l. The permittee may report all results below the minimum level as <0.10 mg/l (less than 0.10 mg/l).

II. SPECIAL CONDITIONS

B.1 Minimum Monitoring Requirements - Monitoring Point 101⁽²⁹⁾:

The effluent characteristics listed below shall be monitored:

<u>Effluent Characteristics</u>	<u>Monitoring Period</u>	<u>Measurement Frequency</u>	<u>Sample Type</u>
BOD ₅ ⁽¹²⁾	All Year	5 Days per Week	24-hour composite
Total Suspended Solids ⁽¹²⁾⁽¹⁵⁾⁽¹⁸⁾	All Year	5 Days per Week	24-hour composite
Total Ammonia Nitrogen as N ⁽¹²⁾⁽¹⁴⁾	All Year	One per Day	24-hour composite
Total Phosphorus as P ⁽¹²⁾⁽¹⁵⁾	All Year	One per Day	24-hour composite
Total Nitrogen as N ⁽¹²⁾⁽¹⁴⁾⁽¹⁵⁾	All Year	One per Day	Calculated
(Nitrite + Nitrate) as N ⁽¹²⁾⁽¹³⁾⁽¹⁴⁾	All Year	One per Day	24-hour composite
Organic Nitrogen as N ⁽¹²⁾⁽¹³⁾⁽¹⁴⁾	All Year	One per Day	24-hour composite
Orthophosphate as P ⁽¹²⁾⁽¹³⁾	All Year	One per month	24-hour composite
Flow ⁽¹²⁾⁽¹⁹⁾⁽²⁰⁾	All Year	Continuous	Recorded ⁽²⁰⁾
Total Monthly Flow ⁽¹²⁾⁽²¹⁾	All Year	Monthly	Calculated ⁽²¹⁾
E. Coli ⁽¹²⁾⁽²¹⁾	All Year	Three per week	Grab
Total Residual Chlorine ⁽¹²⁾⁽¹⁶⁾	All Year	Three per day	Grab
Dissolved Oxygen ⁽¹²⁾⁽¹⁸⁾	All Year	Two per Day	Grab
pH ⁽¹²⁾⁽¹⁸⁾	All Year	Two per Day	Grab

II. SPECIAL CONDITIONS

B.2 Minimum Monitoring Requirements - Outfall 001:

The effluent characteristics listed below shall be monitored:

<u>Effluent Characteristics</u>	<u>Monitoring Period</u>	<u>Measurement Frequency</u>	<u>Sample Type</u>
BOD ₅ ⁽¹²⁾	All Year	5 Days per Week	Calculated
Total Suspended Solids ⁽¹²⁾⁽¹⁸⁾⁽²⁶⁾	All Year	5 Days per Week	Calculated
Total Ammonia Nitrogen as N ⁽¹²⁾⁽¹⁴⁾	All Year	One per Day	Calculated
Total Phosphorus as P ⁽¹²⁾⁽²⁶⁾	All Year	One per Day	Calculated
Total Nitrogen as N ⁽¹²⁾⁽¹⁴⁾⁽²⁶⁾	All Year	One per Day	Calculated
(Nitrite + Nitrate) as N ⁽¹²⁾⁽¹³⁾⁽¹⁴⁾	All Year	One per Day	Calculated
Organic Nitrogen as N ⁽¹²⁾⁽¹³⁾⁽¹⁴⁾	All Year	One per Day	Calculated
Orthophosphate as P ⁽¹²⁾⁽¹³⁾	All Year	One per month	Calculated
Flow ⁽¹²⁾⁽¹⁹⁾⁽²⁸⁾	All Year	Daily	Calculated
Total Monthly Flow ⁽¹²⁾	All Year	Monthly	Calculated ⁽²¹⁾

II. SPECIAL CONDITIONS

B.3 Non-Potable Water Requirements- Monitoring Point **102** (Pumping Station): The non-potable water flow and total residual chlorine (TRC) concentrations shall be monitored, and the other effluent characteristics listed below calculated:

<u>Effluent Characteristics</u>	<u>Monitoring Period</u>	<u>Measurement Frequency</u>	<u>Sample Type</u>
Total Suspended Solids ⁽¹²⁾⁽¹⁸⁾⁽²⁷⁾	All Year	5 Days per Week	Calculated
Total Phosphorus as P ⁽¹²⁾⁽²⁷⁾	All Year	One per Day	Calculated
Total Nitrogen as N ⁽¹²⁾⁽¹⁴⁾⁽²⁷⁾	All Year	One per Day	Calculated
Flow ⁽¹²⁾⁽¹⁹⁾⁽²⁰⁾	All Year	Continuous	Recorded ⁽²⁰⁾
Total Monthly Flow ⁽¹²⁾⁽²¹⁾	All Year	Monthly	Calculated ⁽²¹⁾
Total Residual Chlorine ⁽¹²⁾⁽¹⁷⁾	All Year	One per Day	Grab

Monitoring Requirements, Continued:

Footnotes for the monitoring requirement

- (12) "STORET" (short for STorage and RETrieval) is a widely-used repository for water quality data reporting and monitoring. The STORET codes for the effluent characteristics described as limitations and/or monitoring requirements are: BOD₅ (00310), Total Suspended Solids (00530), Total Ammonia Nitrogen as N (00610), Total Phosphorus as P (00665), Total Nitrogen as N (00600), (Nitrite + Nitrate) as N (00630), Organic Nitrogen as N (00605), Orthophosphate as P (04175), E. Coli (51040), Total Residual Chlorine (50060), Dissolved Oxygen (00300), pH (00400), Flow (50050), Total monthly flow (82220).
- (13) This parameter (without effluent limitations) must be monitored, and it shall be reported on the Monthly Operating Report (MOR) as individual results and on the Discharge Monitoring Report (DMR) (EPA Form 3320-1) as monthly average concentrations.
- (14) Total nitrogen as N (in mg/l) is a calculated parameter as the sum of individual results for total ammonia nitrogen as N, organic nitrogen as N and (nitrite + nitrate) as N. All the nitrogen species must be sampled on the same day.
- (15) (Monitoring Point 101 only): Prior to diverting reclaimed water to the Federal System, the permittee shall calculate and report the Monthly Total Loading Rates and the Cumulative Annual Loading Rates for nitrogen, phosphorus, and suspended solids on the DMR (see definition I.H.5.a and H.6.a).
The permittee shall also report on the DMR the Net Monthly Total Loading Rates and the Net Annual Maximum Loading Rates for nitrogen, calculated as the annual cumulated loading rate reported at Monitoring Point 101 LESS the approved OSDS credit load. The Net Monthly Total Loading Rate is the Monthly Total Loading Rate reported at Monitoring Point 101 LESS 80.5 lbs/month (See definition I.H.6), a monthly prorated load based on the approved 966 lbs/year annual credit load (see definition I.H.4).
- (16) The minimum monitoring requirements of three per day-grab samplings for total residual chlorine shall be applicable only when the wastewater at the Little Patuxent WRP is treated with chlorine or any chlorine compound. The minimum detection level (quantification level) for total residual chlorine is 0.10

II. SPECIAL CONDITIONS

- mg/l. The permittee may report all results below the minimum level as <0.10 mg/l. All results reported below the minimum level shall be considered in compliance.
- (17) Monitoring only parameter for effluent reuse purpose. The monitoring results shall be reported as daily minimum and monthly average concentrations (See Special Conditions II.J for additional details).
 - (18) If the monthly average limitations for TSS, dissolved oxygen and pH are exceeded while the monitoring frequency is at 5 per-week for TSS and 2 per-day for DO and pH, then the monitoring frequency for the violated parameter shall automatically revert to once per-day for TSS, and 3 per-day for DO and pH, and remain as such for the permit life cycle.
 - (19) Flows shall be reported in millions gallons per day (mgd) to at least the nearest 10,000 gallons per day. (Example: A flow of 1,524,699 gallons per day shall be reported as 1.53 mgd.). For each calendar month, flows shall be reported on the MOR as daily individual results and on the DMR as monthly average (mgd) and daily maximum (mgd).
 - (20) Continuous electronic flow measurement and recording which can produce a permanent record are acceptable to the Department.
 - (21) "Total monthly flow" is a calculated parameter equal to sum of the daily flow results in a calendar month. It shall be reported on the monthly DMR as Total monthly flow in millions gallons (MG) to at least the nearest 10,000 gallons. (Example: A flow of 1,524,699 gallons shall be reported as 1.53 MG).

B.4 Report Submittal Requirements

Report Description	Reporting Frequency	Report Submittal Deadline
Effluent Biomonitoring Study Plan and Toxic Chemical Testing Plan ⁽²²⁾⁽²³⁾	See footnote – 23	See footnote – 23
Effluent Biomonitoring Study Report ⁽²²⁾⁽²⁴⁾	See footnote- 24	See footnote- 24
Effluent Toxic Chemical Testing Report ⁽²²⁾⁽²⁵⁾	See footnote - 25	See footnote- 25

- (22) If the permittee has selected a third party for submitting reports to the Department, the permittee must provide to the third party with a document of authorization for report submission which is required with the report.
- (23) Within three months from the effective date of this permit, the permittee shall submit the Study Plans for effluent biomonitoring as well as toxic chemical testing and obtain approval from the Department.
- (24) After MDE's approval of the Effluent Biomonitoring Study Plan, the permittee shall perform the effluent biomonitoring study and submit the comprehensive report to the Department as per requirements of the Special Condition II.D. The reporting frequency of this report shall be once per year for four years beginning effective date of this permit. The report shall be submitted to the Department along with the DMR for the month during which the test was completed, and it shall be postmarked by the 28th of the month following the test completion month. (Example: If the test is completed in March, the comprehensive report shall be submitted with the March DMR postmarked by 28th April).
- (25) After MDE's approval of the Effluent Toxic Chemical Testing Plan, the permittee shall perform the effluent toxic chemical testing and submit the comprehensive report to the Department as per requirements of the Special Condition II.F. The reporting frequency of this report shall be once per year for three years beginning effective date of this permit. The report shall be submitted to the Department along with DMR for the month during which the test was completed, and it shall be postmarked by the 28th of the month

II. SPECIAL CONDITIONS

following the test completion month. (Example: If the test is completed in March, the comprehensive report shall be submitted with the March DMR postmarked by 28th April).

- (26) (Outfall 001 only): This monitoring point does not require effluent concentrations monitoring for all parameters. Each month the permittee shall calculate, and report on the DMR, the Monthly Total Loading Rates for all parameters listed in Outfall 001. The Monthly Total Loading Rates for parameters required at outfall 001 shall be calculated based on the effluent concentrations measured daily at monitoring point 101 and the daily flows measured at Outfall 001.
- (27) Monitoring Point 102 in Special Condition B.3: This monitoring point does not include monitoring requirements for concentration. Each month the permittee shall calculate and report on the DMR the TSS, nitrogen, and phosphorus Monthly Total Loading Rates and the Annual Maximum Loading Rates (see definitions H.5.a and H.6.a). The Monthly Total Loading Rates shall be calculated using the daily concentrations measured at MP 101 while applying the daily flows measured at Monitoring Point 102.
- (28) Outfall 001 Daily Flow shall be calculated as the measured flow at Monitoring Point 101 minus the measured flow at Monitoring Point 102.
- (29) The effluent samples at the Sampling Point 101 shall be representative of the effluent quality at Outfall 001. The permittee shall notify the Department and provide justification in accordance with conditions specified in Section III.B.11 of this permit when an alternative sampling location is selected.

C. Capacity Management Plan

The permittee shall report total cumulative flow for the each calendar year for the above referenced facility. The total cumulative flow should be reported in million gallons for the entire calendar year to the nearest ten thousand gallons. The annual total cumulative flow determination shall be provided to the Department by January 28 of the following year to the address below:

Attention: Calendar Year Total Cumulative Flow
WMA – Wastewater Discharge Permits Program
Maryland Department of the Environment
1800 Washington Boulevard, STE-455
Baltimore, MD 21230-1708

A Wastewater Capacity Management Plan must be submitted by January 28 of each calendar year if the most recent three year average flow is over 80% of its design capacity or if it is anticipated to exceed 80 % in the following year. (The Department has published a “Wastewater Capacity Management Plans” guidance document, which can be found on the Department’s web site as indicated below):

<http://www.mde.state.md.us/assets/document/water/WastewaterCapacityMgmtGuidance.pdf>.

II. SPECIAL CONDITIONS

D. BIOMONITORING PROGRAM

1. Within three months of the effective date of the permit, the permittee shall submit to the Department for approval a study plan to evaluate wastewater toxicity at Outfall 001 by using biomonitoring. The study plan should include a discussion of:
 - a. wastewater and production variability
 - b. sampling & sample handling
 - c. source & age of test organisms
 - d. source of dilution water
 - e. testing procedures/experimental design
 - f. data analysis
 - g. quality assurance/quality control
 - h. report preparation
 - i. testing schedule
2. The testing program shall consist of definitive four annual chronic testing events. The testing events shall be conducted annually during January or February of each of the first four years after approval of the study plan. This testing shall be initiated no later than the January or February following the Department's acceptance of the study plan. Each annual testing event shall include the Ceriodaphnia survival and reproduction test and the fathead minnow larval survival and growth test.)
3. The samples used for biomonitoring shall be collected at the same time and location as the samples analyzed for the effluent limitations and monitoring requirements for this outfall. For chlorinated effluents, samples shall be collected after dechlorination. The permittee shall collect 24-hour flow-proportioned composite samples unless the Department has given prior approval of an alternative sampling type.
4. The following EPA document discusses the appropriate methods:

Short-term Methods for Estimating the Chronic Toxicity of Effluents and Receiving Waters to Freshwater Organisms Fourth Edition, EPA-821-R-02-013, October, 2002

II. SPECIAL CONDITIONS

5. Test results shall be submitted to the Department within one month of completion of each set of tests.
6. Test results shall be reported in accordance with MDE/WMA "Reporting Requirements for Effluent Biomonitoring Data," 3/21/03.
7. As a minimum, the reported chronic results shall be expressed as NOEC, LOEC, ChV, and IC₂₅.
8. If a 50% mortality or greater occurs in one or more effluent concentrations during the first 48 hours of the chronic tests, 48-hour LC₅₀s shall be calculated and reported along with the chronic results
9. If testing is not performed in accordance with MDE-approved study plan, additional testing may be required by the Department.
10. If the test results of any two consecutive valid toxicity tests show acute or chronic toxicity (LC₅₀ equal to or less than 100% for acute tests and an IC₂₅ equal to or less than the in-stream waste concentration for chronic tests), the permittee shall repeat the test within 30 days to confirm the findings of acute or chronic toxicity. Intermittent toxicity or other concerns may require additional testing or limits. If acute and/or chronic toxicity is confirmed, the permittee shall:
 - a. Eliminate the source of toxicity through operational changes as soon as possible but in any case not longer than within three months, or
 - b. Perform a TRE. If the permittee repeats the toxicity testing as stated above and the results of the repeat test do not confirm the acute or chronic toxicity, the Department will require the permittee to repeat the toxicity testing as stated above to reconfirm a finding of no acute or chronic toxicity. After reconfirmation, the permittee shall complete any remaining quarterly testing required.
11. If the permittee completes a TRE in accordance with II.E.10.b and unacceptable toxicity is confirmed, a Whole Effluent Toxicity (WET) permit limit and a compliance schedule will be required.
12. To address federal NPDES requirements for WET testing and limits, MDE shall implement permit limits in a new or renewal permit when a WET test result shows reasonable potential for toxicity unless it can be demonstrated that the source of toxicity has been eliminated, inappropriate test procedures were utilized, or the source has been controlled via a chemical specific permit limitation. Where reasonable potential has been assumed based on one test result, the permit shall include a WET limit effective within three years unless

II. SPECIAL CONDITIONS

the effluent shows no toxicity in six follow-up quarterly tests. The permit may be modified to remove the WET limit if the six follow-up quarterly tests show no toxicity.

13. If plant processes or operations change so that there is a significant change in the nature of the wastewater, the Department may require the permittee to conduct a new set of tests.
14. If a significant industrial user locates within the service area so that significant change in the nature of the wastewater might be anticipated, MDE may require the permittee to conduct a new set of tests.
15. Submit all Biomonitoring related materials to:

Maryland Department of the Environment
Water Management Administration
Compliance Program
1800 Washington Blvd., Suite 420
Baltimore, MD 21230-1708

E. Toxicity Reduction Evaluation (TRE)

The permittee shall conduct a Toxicity Reduction Evaluation (TRE) when a review of toxicity test data by the Department indicates unacceptable acute or chronic effluent toxicity. A TRE is an investigation conducted to identify the causative agents of effluent toxicity, isolate the source(s), determine the effectiveness of control options, implement the necessary control measures and then confirm the reduction in toxicity.

1. Within 90 days of notification by the Department that a TRE is required, the permittee shall submit for approval by the Department a plan of study, schedule and completion date for conducting a TRE. The permittee shall conduct the TRE study consistent with the submitted plan and schedule.
2. This plan should follow the framework presented in Toxicity Reduction Evaluation Guidance for Municipal Wastewater Treatment Plants (EPA/833B-99/002) August 1999.

Additional Guidance documents on the TRE process are shown below:

Methods for Aquatic Toxicity Identification Evaluations Phase I Toxicity Characterization Procedures, Second Edition, United States Environmental Protection Agency Office of Research and Development Washington, DC 20460, EPA/600/6-91/003 February 1991.

II. SPECIAL CONDITIONS

Methods for Aquatic Toxicity Identification Evaluations Phase II Toxicity Identification Procedures for Samples Exhibiting Acute and Chronic Toxicity, United States Environmental Protection Agency Office of Research and Development, EPA/600/R-92/080 September 1993 Washington DC 20460.

Methods for Aquatic Toxicity Identification Evaluations Phase III Toxicity Confirmation Procedures for Samples Exhibiting Acute and Chronic Toxicity, United States Environmental Protection Agency Office of Research and Development Washington DC 20460, EPA /600/R-92/08 1 September 1993.

Clarifications Regarding Toxicity Reduction and Identification Evaluations in the National Pollutant Discharge Elimination System Program, March 27, 2001, U.S. Environmental Protection Agency, Office of Wastewater Management , Office of Regulatory Enforcement, Washington, DC 20460.

3. Beginning 60 days from the date of the Department's acceptance of the TRE study plan and every 60 days thereafter, the permittee shall submit progress reports including all relevant test data to the Department. This shall continue until completion of the toxicity reduction confirmation.
4. Within 60 days of completion of the toxicity identification or the source identification phase of the TRE, the permittee shall submit to the Department a plan, schedule and completion date for implementing those measures necessary to eliminate acute toxicity, an LC50 greater than 100%, and/or eliminate chronic toxicity, an IC25 greater than the in-stream waste concentration (IWC). The implementation of these measures shall begin immediately upon submission of this plan.
5. Within 60 days of completing the implementation of the control measures to eliminate or reduce toxicity, the permittee shall submit to the Department for approval a study plan to confirm the elimination or reduction of toxicity by using biomonitoring.
6. If, for any reason, the implemented measures do not result in compliance with the Department's toxicity limitations, the permittee shall continue the TRE and a Whole Effluent Toxicity (WET) permit limit and a compliance schedule will be required.
7. Submit all TRE-related materials to:

Maryland Department of the Environment
Water Management Administration
Compliance Program
1800 Washington Blvd., Suite 420
Baltimore, MD 21230-1708

II. SPECIAL CONDITIONS

F. Toxic Chemical Testing

1. Concurrent with the biomonitoring study plan, the permittee shall submit to the Department for approval, a study plan to perform three sets of analytical testing for toxic chemicals.
2. The toxic chemical testing study plan shall include a description of:
 - a. sampling methods;
 - b. analytical methods;
 - c. practical detection levels; and
 - d. quality control procedures.
3. Concurrently with the first three biomonitoring toxicity tests, the permittee shall perform analytical testing for the toxic chemicals identified in the Department's "Toxic Pollutant Monitoring Protocol and Reporting Requirements for Toxic Chemical Testing Analytical Data" (05/18/2011).
4. Substances other than those identified in Section 3 above may be detected in the effluent. If so, the permittee shall identify and quantify the ten present in highest concentration for those compounds for which standards are available.
5. Results of each toxic chemical test performed as per Sections II.F.3 and II.F.4 shall be submitted to the Department with results of the concurrent biomonitoring toxicity test.
6. Toxic chemical testing results shall be reported in accordance with the Department's "Toxic Pollutant Monitoring Protocol and Reporting Requirements for Toxic Chemical Testing Analytical Data" (05/18/2011).
7. If testing is not performed in accordance with the Department's approved study plan, additional testing may be required by the Department.
8. Submit all toxic chemical testing related materials to:

Attention: Toxic Chemical Data
Maryland Department of the Environment
Water Management Administration
Compliance Program
Montgomery Park Business Center
1800 Washington Boulevard, STE 420
Baltimore, MD. 21230-1708

II. SPECIAL CONDITIONS

G. Pretreatment Program

The permittee shall operate and maintain the pretreatment program in accordance with COMAR 26.08.08, the General Pretreatment Regulations for Existing and New Sources of Pollution (40 CFR Part 403) and the approved pretreatment program submission as approved on 08/07/1985 by the Department. The program must be updated if needed to comply with COMAR 26.08.08 or 40 CFR Part 403 or modifications to the State of Maryland Publicly Owned Treatment Works (POTW) Pretreatment Delegation Agreement signed on 11/07/1991 and as amended on 07/09/2001. The terms of the POTW Pretreatment Delegation Agreement are expressly incorporated herein as if set forth in full.

H. Protection Of Water Quality

It is a violation of this permit to discharge any substance not otherwise listed under the permit's "Effluent Limitations and Monitoring Requirements" special conditions at a level which would cause or contribute to any exceedance of the numerical water quality standards in COMAR 26.08.02.03 unless the level and the substance were disclosed in writing in the permit application prior to the issuance of the permit. If a discharge regulated by this permit causes or contributes to an exceedance of the water quality standards in COMAR 26.08.02.03, including but not limited to the general water quality standards, or if the discharge includes a pollutant that was not disclosed or addressed in the public record for the permit determination, the Department is authorized to modify, suspend or revoke this permit or take enforcement action to address unlawful discharges of pollutants.

I. Reapplication for a Permit

No later than 04/01/2017, unless permission for a later date has been granted by the Department, the permittee shall submit a new application for a permit or notify the Department of the intent to cease discharging by the expiration date. In the event that a timely and complete reapplication has been submitted and the Department is unable, through no fault of the permittee, to issue a new permit before the expiration date of this permit, the terms and conditions of this permit continue and remain fully effective and enforceable. The renewal application is required by that date in accordance with the requirements of MDE's Watershed Permitting Plan under which all discharge permits in a watershed should be issued in the same year.

II. SPECIAL CONDITIONS

J. Reclaimed Water Total Residual Chlorine Concentration and Turbidity Requirements.

- (a) The Permittee shall ensure that the effluent supplied from the Little Patuxent Water Reclamation Plant (WRP) is chlorinated and maintained with adequate level of free chlorine residual in the reclaimed water system when it reaches the receiving reclaimed water tank at the Federal Facility. The permittee shall monitor the residual chlorine in the reclaimed water sent to the Federal Facility continuously at the pumping station specified as Monitoring Point **102** in this permit. The results of the residual chlorine monitoring shall be reported in the Discharge Monitoring Report (DMR, EPA Form 3320-1) as monthly average concentrations and submitted to the Department. The permittee shall provide re-chlorination infrastructures at the elevated reclaimed water tank located inside the Federal Facility area to ensure additional chlorine, if necessary, can be added to the reclaimed water system to ensure that detectable chlorine residual level is maintained in the reclaimed water on-site storage and prior to use in the cooling water makeup system.
- (b) The permittee shall install a continuous on-line turbidity meter at the reclaimed water pumping station (Monitoring Point **102**) for continuous monitoring on the turbidity of the re-claimed water sent to the Federal facility in accordance with the procedures specified in 40 CFR 136. The monitoring records for turbidity shall be maintained by the facility to be available upon request from the Department. Data obtained from the continuous on-line analyzer shall be reported to MDE along with the monitoring data for free residual chlorine as specified above. In the event when turbidity exceeds 5 NTU in the supplied reuse water, the permittee shall notify the Federal Facility to use an alternative water source in lieu of the cooling tower storage tank reclaimed water. In addition, the Reclaimed Water Pumping Station shall be temporarily shut-off until proper turbidity level is restored". The results of the turbidity monitoring shall be reported in the Discharge Monitoring Report (DMR, EPA Form 3320-1) as daily maximum NTUs and submitted to the Department.

K. Reclaimed Water Supplier and User Obligations.

To ensure mutual understanding on the obligations to comply with the total residual chlorine and turbidity requirements specified in this permit. The permittee shall submit a "Memorandum of Understanding" (MOU) between the supplier and user of the reclaimed water to the Department with the above permit requirements incorporated.

III. GENERAL CONDITIONS

A. Monitoring and Reporting

1. Representative Sampling

Samples and measurements shall be taken at times that are representative of the quantity and quality of the discharge, and at evenly spaced intervals.

2. Monthly Monitoring Results

a. Discharge Monitoring Reports

Monitoring results obtained each month shall be summarized on a Discharge Monitoring Report form (EPA No. 3320-1). The permittee shall submit the Discharge Monitoring Reports to the Department postmarked no later than the 28th of the month following the reporting month. A signed original plus a copy of these reports shall be submitted to:

Attention: Discharge Monitoring Reports
WMA - Compliance Program
Maryland Department of the Environment
1800 Washington Boulevard, STE-425
Baltimore, MD 21230-1708

A signed copy of these reports shall also be sent to:

U.S. Environmental Protection Agency, Region III
NPDES Enforcement Branch (3WP42)
1650 Arch Street
Philadelphia, Pennsylvania 19103-2029

Paper DMR submittal to MDE and U.S EPA as required above shall be applicable until the NetDMR submittal program is finalized and implemented by the Little Patuxent Water Reclamation facility. Upon the implementation, the permittee shall submit NetDMR to comply with the Discharge Monitoring Report (DMR) submittal requirements.

b. Monthly Operating Reports

The permittee shall submit monthly operating reports on a form acceptable to the Compliance Program. A signed original plus a copy of these reports shall be submitted to the Compliance Program postmarked no later than the 28th day of the month following the reporting month.

III. GENERAL CONDITIONS

c. Toxic Chemical Reporting

Any data collected according to the Department's "Toxic Pollutant Monitoring Protocol and Reporting Requirements for Toxic Chemical Testing Analytical Data" (05/18/2011) being submitted to the Department, either in fulfillment of Special Conditions II.B or pursuant to the toxic chemical testing requirement, pretreatment requirements or toxic metals or organic data collected on a voluntary basis, must be accompanied by laboratory data reports. At a minimum, these reports shall include, the name of the facility, the date(s) of sampling, beginning and ending sample time, place of sampling collection, the sample type (grab, composite, etc.), the sample description (influent or effluent), the preservation method, the analytical method used for each parameter, the analytical method detection limit, the date of analysis, the name of person performing the analysis, the analytical result, and the name and address of the laboratory performing the analyses. Chain-of-custody forms shall also be submitted. This information, along with the supporting documentation, shall be submitted to:

Attention: Toxic Chemical Data
WMA – Compliance Program
Maryland Department of the Environment
1800 Washington Boulevard, STE 420
Baltimore, Maryland 21230-1708

3. Sampling and Analysis Methods

Analytical and sampling methods shall conform to test procedures for the analysis of pollutants as identified in 40 CFR Part 136 - "Guidelines Establishing Test Procedures for the Analysis of Pollutants."

4. Analytical Laboratory

Within 30 days after the effective date of this permit, the permittee shall submit to the Department the name and address of the analytical laboratory (including the permittee's own laboratory) which is used to perform the monitoring required by this permit.

If the laboratory changes during the effective period of this permit, the permittee shall notify the Department of the new laboratory within 30 days after the change.

III. GENERAL CONDITIONS

5. Monitoring Equipment Maintenance

- a. The permittee shall calibrate and maintain all monitoring and analytical instrumentation to ensure accuracy of measurements.
- b. Environment Article, Section 9-343 provides that any person who falsifies, tampers with, or knowingly renders inaccurate, any monitoring device or method required to be maintained under this permit shall, upon conviction, be punished by a fine of not more than \$10,000 per violation, or by imprisonment for not more than six months per violation, or by both.

6. Recording of Results

For each measurement or sample taken pursuant to the requirements of the permit, the permittee shall record the following information:

- a. the date, exact place and time of sampling or measurement;
- b. the person(s) who performed the sampling or measurement;
- c. the dates analyses were performed;
- d. the person(s) who performed each analysis;
- e. the analytical techniques or methods used; and
- f. the results of such analyses.

7. Additional Monitoring by Permittee

If the permittee monitors any pollutant at the location(s) designated herein more frequently than required by this permit, using approved analytical methods as specified above, the results of such monitoring shall be included in the calculation and reporting of the values required in the Discharge Monitoring Report form (EPA No. 3320-1). The increased frequency shall also be reported. The results of any other monitoring performed by the permittee shall be made available to the Department upon request.

8. Record Retention

All data used to complete the permit application and all records and information resulting from the monitoring activities required by this permit, including all records of sampling and analyses performed, calibration and maintenance of

III. GENERAL CONDITIONS

instrumentation, and recordings from continuous monitoring instruments, shall be retained for a minimum of three years. This period shall be extended automatically during the course of litigation or when requested by the Department.

B. General Requirements

1. Permit Noncompliance - Notification Requirements

All discharges authorized herein shall be consistent with the terms and conditions of this permit. If, for any reason, the permittee does not comply with or will be unable to comply with any permit condition, the permittee shall, within 24 hours, notify the Department by telephone at (410) 537-3510 during work hours or at (866) 633-4686 during evenings, weekends, and holidays. The permittee shall provide the Department with the following information in writing within five days of such oral notification.

- a. a description of the noncomplying discharge including the name of the stream and the impact upon the receiving waters;
- b. cause of noncompliance;
- c. the duration of the period of noncompliance and the anticipated time the condition of noncompliance is expected to continue;
- d. steps taken by the permittee to reduce and eliminate the noncomplying discharge;
- e. steps to be taken by the permittee to prevent recurrence of the condition of noncompliance;
- f. a description of the accelerated or additional monitoring to determine the nature and impact of the noncomplying discharge; and
- g. the results of the monitoring described in f. above.

2. Change in Discharge

The permittee shall report any anticipated facility expansions, production increases, or process modifications which will result in new, different or an increased discharge of pollutants by submitting a new application at least 180 days prior to the commencement of the changed discharge except that if the change only affects a listed pollutant and will not violate the effluent limitations specified in this permit, by providing written notice to the Department. Following such notice, the permit may be modified by the Department to include new effluent limitations on those pollutants.

III. GENERAL CONDITIONS

3. Facility Operation and Quality Control

All waste collection, control, treatment and disposal facilities shall be operated in a manner consistent with the following:

- a. Facilities shall be operated efficiently to minimize upsets and discharges of excessive pollutants.
- b. The permittee shall provide an adequate operating staff qualified to carry out operation, maintenance and testing functions required to ensure compliance with this permit. Superintendents and operators must be certified by the Board of Waterworks and Waste Systems Operators located at Montgomery Park Business Center, 1800 Washington Boulevard, STE- 410, Baltimore, Maryland 21230 in accordance with Title 12 of Environmental Article, Annotated Code of Maryland, and Section 26.06.01 of the COMAR.
- c. Facility maintenance work, which adversely affects or may adversely affect the discharge quality shall be scheduled during non-critical water quality periods.

4. Adverse Impact

The permittee shall take all reasonable steps to minimize any adverse impact to waters of this State, human health or the environment resulting from noncompliance with any effluent limitations specified in this permit, and must perform accelerated or additional monitoring as necessary to determine the nature and impact of the noncomplying discharge.

5. Bypassing

Any bypass of treatment facilities is prohibited unless the bypass does not cause any violations of the effluent limitations specified in Special Condition II.A, and is for essential maintenance to assure efficient operation, or unless the permittee can prove that:

- a. the bypass is unavoidable to prevent loss of life, personal injury, or substantial physical damage to property, damage to the treatment facilities which would cause them to become inoperable, or substantial and permanent loss of natural resources; and
- b. there are no feasible alternatives to the bypass; and

III. GENERAL CONDITIONS

- c. the Department receives notification pursuant to General Condition III.B.1 above. Where the need for a bypass is known (or should have been known) in advance, this notification shall be submitted to the Department for approval at least ten days before the date of the bypass or at the earliest possible date if the period of advance knowledge is less than ten days; and
- d. the bypass is allowed under conditions approved by the Department to be necessary to minimize adverse effects.

6. Conditions Necessary for Demonstration of Upset

An upset shall constitute an affirmative defense to an action brought for noncompliance with technology-based effluent limitations only if the permittee demonstrates, through properly signed, contemporaneous operating logs, or other relevant evidence, that:

- a. an upset occurred and that the permittee can identify the specific cause(s) of the upset;
- b. the permitted facility was at the time being operated in a prudent and workman-like manner and in compliance with proper operation and maintenance procedures;
- c. the permittee submitted a 24-hour notification of upset in accordance with the reporting requirements of General Condition III.B.1 above;
- d. the permittee submitted, within five calendar days of becoming aware of the upset, documentation to support and justify the upset; and
- e. the permittee complied with any remedial measures required to minimize adverse impact.

In any enforcement proceeding, the permittee seeking to establish the occurrence of an upset has the burden of proof.

7. Sewage Sludge Requirements

The permittee shall comply with all State and federal laws and regulations regarding Sewage Sludge Management, and with any regulations promulgated pursuant to Environment Article, Section 9-230 et seq. or to the Clean Water Act, Section 405 (d). A Sewage Sludge Utilization Permit is required for the collection, handling, burning, storage, treatment, land application, disposal, or transportation of sewage sludge, processed sewage sludge, or any product containing these materials in Maryland.

III. GENERAL CONDITIONS

8. Power Failure

The permittee shall maintain compliance with the effluent limitations and all other terms and conditions of this permit in the event of a reduction, loss or failure of the primary source of power to the wastewater collection and treatment facilities.

9. Right of Entry

The permittee shall allow the Secretary of the Department, the Regional Administrator of the Environmental Protection Agency, and their authorized representatives, upon the presentation of credentials to enter upon the permittee's premises and:

- a. to have access to and to copy any records required to be kept under the terms and conditions of this permit;
- b. to inspect any monitoring equipment or monitoring method required in this permit;
- c. to inspect any collection, treatment, pollution management, or discharge facilities required under this permit; or
- d. to sample any discharge of pollutants.

10. Property Rights/Compliance With Other Requirements

The issuance of this permit does not convey any property rights in either real or personal property, or any exclusive privileges, nor does it authorize any injury to private property, invasion of personal rights, or any infringement of federal, State or local laws or regulations.

11. Reports and Information

- a. Upon request, the permittee shall provide to the Department, within a reasonable time, copies of records required to be kept by this permit. The permittee shall also furnish to the Department, within a reasonable time, any information which the Department may request to determine whether cause exists for modifying, revoking and reissuing, or terminating this permit; or to determine compliance with this permit.
- b. All applications, reports or documents submitted to the Department shall be signed and certified as required by COMAR 26.08.04.01 and 40 CFR 122.22.

III. GENERAL CONDITIONS

- c. Except for data determined to be confidential under COMAR 26.08.04.01, all data shall be available for public inspection at the Department and the Office of the Regional Administrator of the Environmental Protection Agency. Effluent data shall not be considered confidential.
- d. Environment Article, Section 9-343 provides that any person who knowingly makes any false statement, representation, or certification in any record or other document submitted or required to be maintained under this permit, including monitoring reports or reports of compliance or noncompliance, shall upon conviction be punished by a fine of not more than \$10,000 or by imprisonment for not more than six months or by both.

12. Transfer of Ownership or Control

In the event of any change in ownership or control of facilities from which the authorized discharge emanates, the permit may be transferred automatically to another person only if:

- a. the current permittee notify the Department, in writing, of the proposed transfer at least 30 days prior to the proposed transfer date;
- b. the notice includes a written agreement between the existing permittee and a new permittee containing the specific date of proposed transfer of permit coverage, and of responsibilities and liabilities under the permit; and
- c. neither the current permittee nor the new permittee receive notification from the Department, within 30 days of the Department's receipt of the agreement, of its intent to modify, revoke, reissue or terminate the existing permit. If this notice is not received, the transfer is effective on the date specified in the agreement mentioned in paragraph 12(b) above.

13. New Effluent Standards

This permit shall be revoked and reissued or modified to meet any effluent standard, water quality standard or prohibition established under the Environment Article, the Clean Water Act, or regulations promulgated thereto, and the permittee shall be so notified.

III. GENERAL CONDITIONS

14. Industrial Users

The permittee shall require all industrial users of the wastewater treatment facility to comply with user charges as established by the permittee, pursuant to Section 9-326(a)(i) of the Environment Article.

15. Noncompliance

Nothing in this permit shall be construed to preclude the institution of any legal action for noncompliance with State, federal or local laws and regulations.

16. Oil and Hazardous Substance Liability

Nothing in this permit shall be construed to preclude the institution of any legal action against the permittee or to relieve the permittee from any responsibilities, liabilities, or penalties to which the permittee is or may be subject under Section 311 of the Clean Water Act or under the Environment Article.

17. Waterway Construction and Obstruction

The permit does not authorize the construction or placing of physical structures, facilities, debris, or the undertaking of related activities in any waters of this State including the 100 year flood plain.

18. Construction Permit

This permit is not a permit to construct. For a new facility, in order to make this permit valid, a construction permit shall be obtained to meet the requirements of COMAR 26.03.12.03(A) and Environment Article, Section 9-204(d).

19. Severability

If any provision of this permit shall be held invalid for any reason, the remaining provisions shall remain in full force and effect, and such invalid provisions shall be considered severed and deleted from this permit.

III. GENERAL CONDITIONS

C. Wastewater Collection System

This permit shall not authorize discharges from the wastewater collection system for this facility.

1. Reporting Requirements

Pursuant to Environment Article Sub title 9-331.1, the permittee must report sanitary sewer overflows (SSOs) which result in the direct or potential discharge of raw or diluted sewage into the surface waters or ground waters of the State to the Water Management Administration's Compliance Program. Concurrently, the permittee shall also notify the local health department. Such reports must be made via telephone as soon as practicable, but no later than 24 hours after the time that the permittee became aware of the event. Reportable SSOs include, but are not limited to, overflows into the surface of the ground, into waterways, storm drains, ditches or other manmade or natural drainage conveyances to surface or ground waters which are reasonably likely to reach waters of the State. Overflows that are wholly contained within buildings and not likely to discharge to waterways need not be reported. Treatment plant bypasses shall be reported under General Condition III.B.1. Telephone reports shall be made to (410) 537-3510 on weekdays between 8:00 a. m. and 5:00 p.m. After hours telephone notification shall be made to emergency response number at (866) 633-4686.

When the incident is reported to the Department, the following information needs to be included:

- a. the location of the overflow, including city or county,
- b. the name of the receiving water, if applicable;
- c. an estimate of the volume of sewage discharged;
- d. a description of the sewer system or treatment plant component from which the overflow was released (such as manhole, crack in pipe, pumping station wet well or constructed overflow pipe);
- e. an estimate of the overflow's impact upon public health and to waters of the State;
- f. the cause or suspected cause of the overflow;
- g. the estimated date and time when the overflow began and stopped or the anticipated time the overflow is expected to continue;

III. GENERAL CONDITIONS

- h. if known at the time of reporting, the steps taken or planned to reduce, eliminate and prevent reoccurrence of the overflow and a schedule of major milestones for those steps; (if unknown at the time the telephone report is made, the steps must be included in the written reports submitted under general conditions III.C.2).
- i. if known at the time of reporting, measures taken or planned to mitigate the adverse impact of the overflow and a schedule of major milestones for those steps (if unknown at the time the telephone report is made, the steps must be included in the written reports submitted under general conditions III.D.2); and
- j. whether there has already been a notification to the public and other City or County Agencies or Departments and how notification was done.

2. Written Reports

Within 5 calendar days following telephone notification of the event, the permittee shall provide MDE with a written report regarding the incident that includes, at a minimum, the information cited above.

The permittee shall maintain copies of all overflow records and reports, work orders associated with investigation of overflows, a list and description of complaints from customers or others related to overflows (including backups of sewage in to houses or businesses), and documentation of performance and implementation measures for minimum period of three years and shall make this information available to MDE for review upon written request.

This wastewater collection system provision may be superseded by a general permit for collection systems, when such a permit is issued by MDE and the permittee have been accepted for registration under the permit.

3. Other Requirements

The permittee, as directed by the State or local health department, shall also be responsible for posting notification in close proximity to the affected area/stream and for conducting appropriate water quality sampling as deemed necessary.

III. GENERAL CONDITIONS

D. Permit Expiration, Modification, or Revocation

1. Expiration of Permit

This permit and the authorization to discharge shall expire at midnight on the expiration date of the permit unless the permittee has submitted a timely and complete reapplication pursuant to Section II.I.

2. [Reserved.]

3. Permit Modification - Request of Responsible Permittee

A permit may be modified by the Department upon the written request of the permittee and after notice and opportunity for a public hearing in accordance with the provisions set forth in COMAR 26.08.04.10.

4. Permit Modification, Suspension, Revocation - Violation of Laws

A permit may also be modified, suspended or revoked by the Department, in the event of a violation of the terms or conditions of the permit, or of State or federal laws and regulations and in accordance with the provisions set forth in COMAR 26.08.04.10. This permit may be suspended or revoked upon a final, unreviewable determination that the permittee lacks, or is in violation of, any federal, state, or local approval necessary to conduct the activities authorized by this permit. |

IV. CIVIL AND CRIMINAL PENALTIES

A. Civil Penalties for Violations of Permit Conditions

In addition to civil penalties for violations of State water pollution control laws set forth in Section 9-342 of the Environment Article, Annotated Code of Maryland, the Clean Water Act provides that any person who violates Section 301, 302, 306, 307, 308, 318 or 405 of the Act, or any permit condition or limitation implementing any of such sections in a permit issued under Section 402 of the Act or in a permit issued under Section 404 of the Act, is subject to a civil penalty not to exceed \$32,500 per day for each violation.

B. Criminal Penalties for Violations of Permit Conditions

In addition to criminal penalties for violations of State water pollution control laws set forth in Section 9-343 of the Environment Article, Annotated Code of Maryland, the Clean Water Act provides that:

1. any person who negligently violates Section 301, 302, 306, 307, 308, 318, or 405 of the Act, or any permit condition or limitation implementing any of such sections in a permit issued under Section 402 of the Act, or in a permit issued under Section 404 of the Act, is subject to a fine of not less than \$2,500 nor more than \$27,500 per day of violation, or by imprisonment for not more than one year, or by both.
2. any person who knowingly violates Section 301, 302, 306, 307, 308, 318 or 405 of the Act, or any permit condition or limitation implementing any of such sections in a permit issued under Section 402 of the Act, or in a permit issued under Section 404 of the Act, is subject to a fine of not less than \$5,000 nor more than \$50,000 per day of violation, or by imprisonment for not more than three years, or by both.
3. any person who knowingly violates Section 301, 302, 306, 307, 318 or 405 of the Act, or any permit condition or limitation implementing any of such sections in a permit issued under Section 402 of the Act, or in a permit issued under Section 404 of the Act, and who knows at that time that he thereby places another person in imminent danger of death or serious bodily injury, is subject to a fine of not more than \$250,000 or imprisonment of not more than 15 years, or both.
4. any person who knowingly makes any false material statement, representation, or certification in any application, record, report, plan, or other document filed or required to be maintained under the Act or who knowingly falsifies, tampers with or renders inaccurate any monitoring device or method required to be maintained under the Act, is subject to a fine of not more than \$10,000 or by imprisonment for not more than two years, or by both. |

V. MAP SHOWING DISCHARGE POINT LOCATION

FLOW DIAGRAM

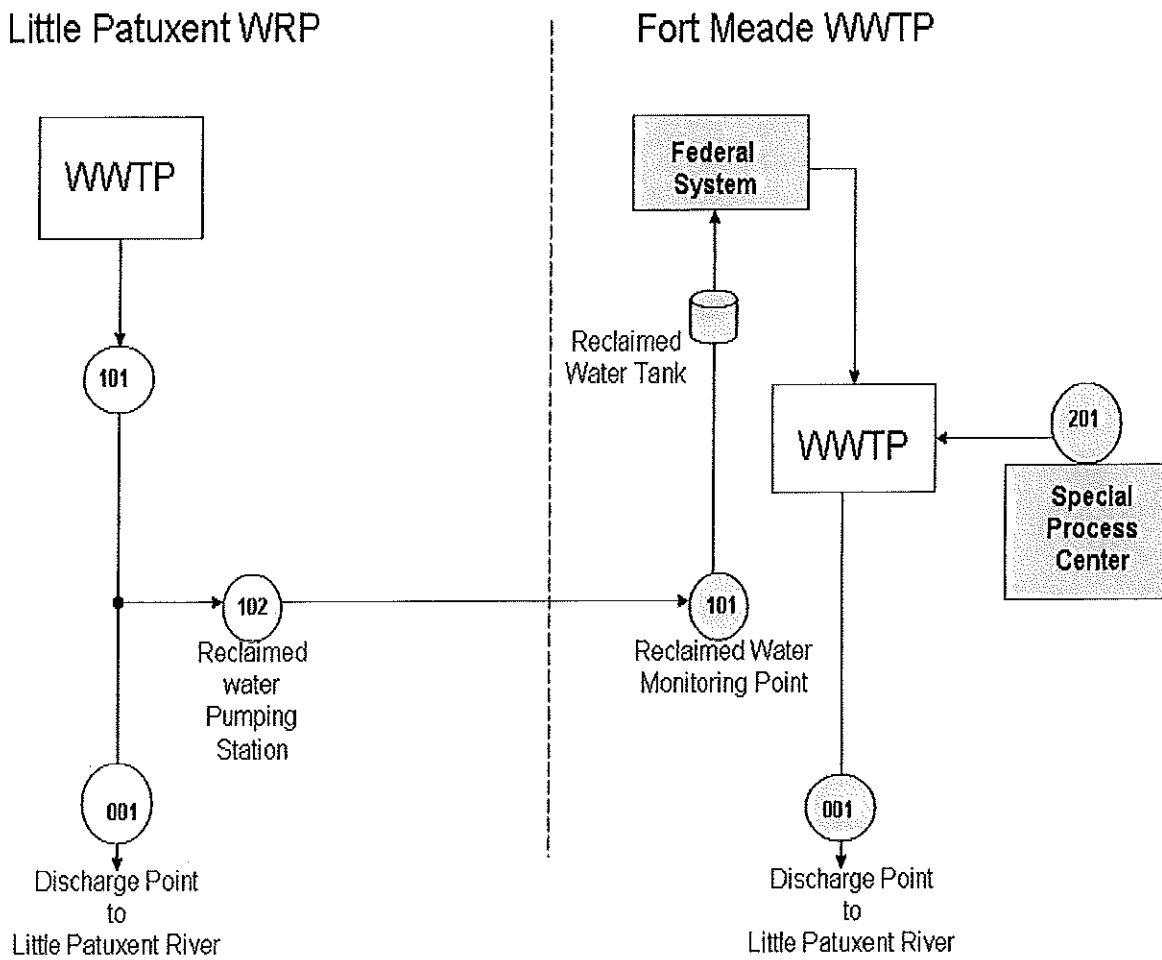

V. MAP SHOWING DISCHARGE POINT LOCATION

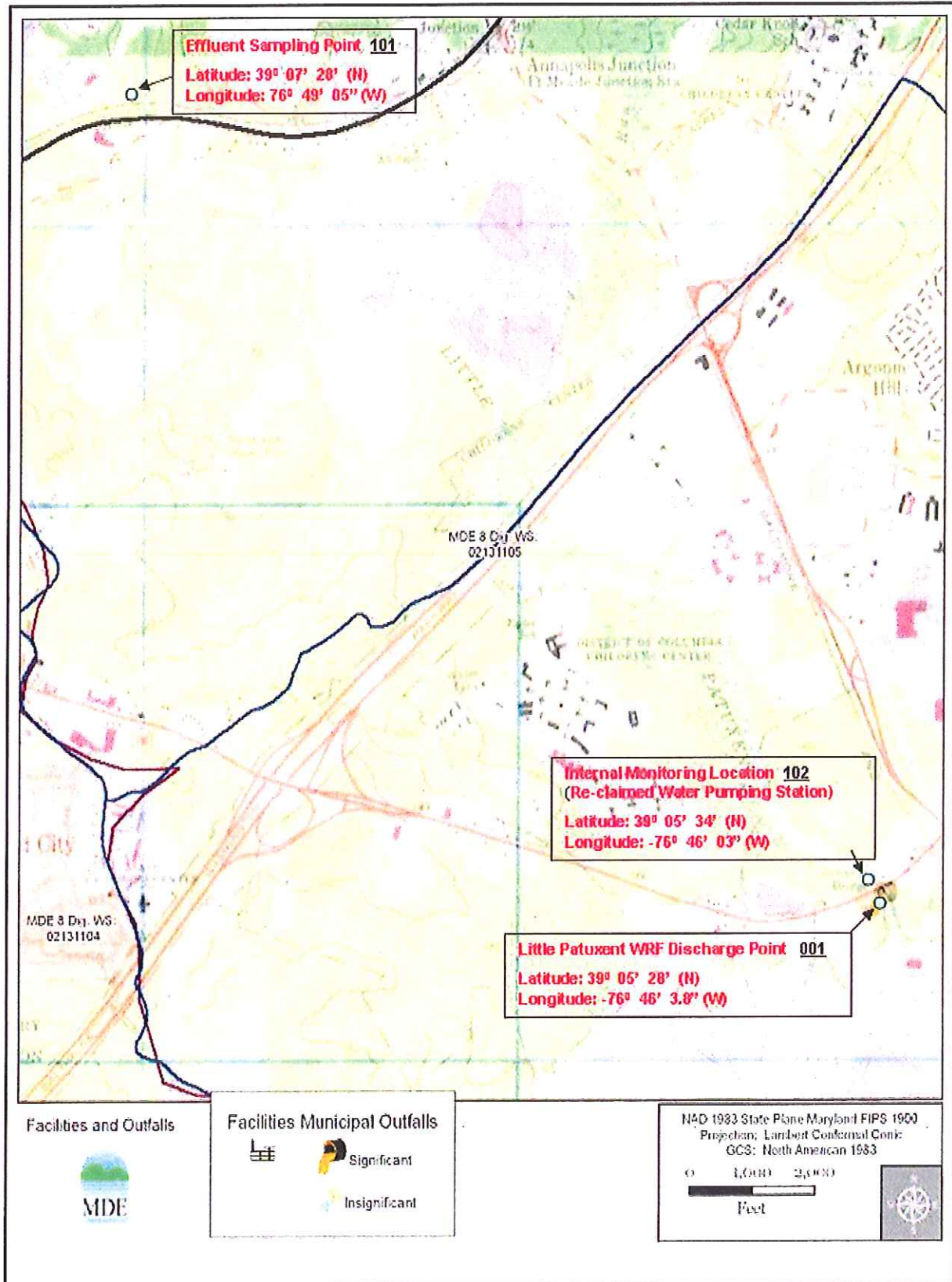

VI. NPDES PROGRAM

APPENDIX - A

Outfalls and Monitoring Points Locations

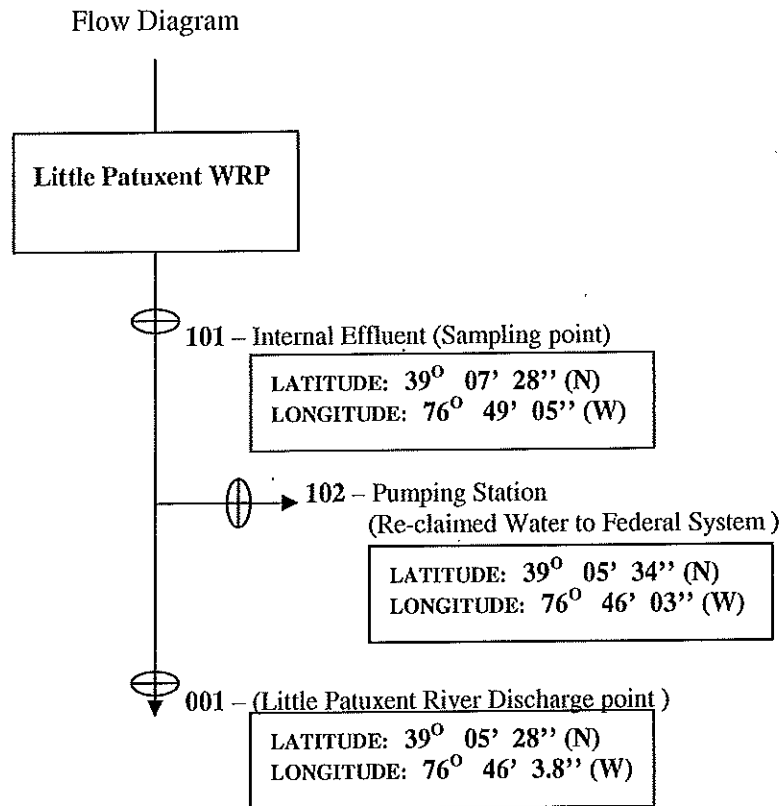

Internal Effluent Sampling Point 101 is the final effluent sample location prior to the diversion of the reclaimed water to the Federal System conveyance pipe (See Flow Diagram and Map, Section V.)

Internal Sampling Point 102 is the re-claimed water diversion location (See Flow Diagram and Map, Section V.)

Discharge Point 001 is the stream's point of discharge at the Little Patuxent River (See Flow Diagram and Map, Section V.)

VI. NPDES PROGRAM

On September 5, 1974, the Administrator of the U.S. Environmental Protection Agency approved the proposal submitted by the State of Maryland for the operation of a permit program for wastewater discharges pursuant to Section 402 of the Clean Water Act.

Pursuant to the aforementioned approval, this discharge permit is both a State of Maryland discharge permit and an NPDES permit.

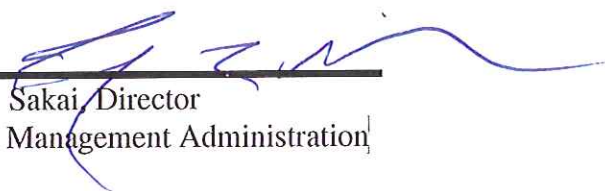

Jay G. Sakai, Director
Water Management Administration

EXHIBIT 10

Water Resources Element April 2010

WATER RESOURCES ELEMENT



An Amendment to
General Plan 2000



PREFACE

During the 2006 legislative session, the Maryland General Assembly enacted House Bill 1141 Land Use – Local Government Planning. HB 1141 requires that local jurisdictions adopt a water resources element in their comprehensive plans. The Howard County Water Resources Element (WRE) serves as an amendment to General Plan 2000 that adds Policies and Actions intended to ensure that the County has adequate water resource capacities to meet future growth needs through 2030.

The Howard County Environmental Sustainability Board, which is comprised of environmental experts that advise the County Executive on environmental matters, served as a citizen’s advisory committee for the Water Resources Element amendment. The Environmental Sustainability Board and Department of Planning and Zoning cosponsored two public meetings in fall 2009 to acquaint the public with the Draft WRE and to solicit comments. The Proposed WRE Amendment was presented to the Planning Board for review at a public hearing in December 2009. The Planning Board unanimously approved a motion to recommend County Council approval of the WRE. The County Council held a public hearing to consider the WRE Amendment in March 2010. By vote of the County Council and signature of the County Executive, the Amendment was approved on April 7, 2010 and became effective on June 8, 2010.

Additional information about the Water Resources Element amendment is available either by contacting the Department of Planning and Zoning or through the Howard County web site at:

<http://www.howardcountymd.gov/>

TABLE OF CONTENTS

EXECUTIVE SUMMARY.....	1
Water Resources Element	1
Drinking Water and Wastewater	1
Water and Related Land Resources.....	2
GENERAL PLAN 2000	5
General Plan Visions	5
The Water Resources Element	5
Planned Service Area and Priority Funding Area	6
Growth Projections	7
DRINKING WATER AND WASTEWATER	9
Introduction	9
The Provision of Public Water and Sewer Services	9
Drinking Water	10
The Public Water System	10
Outside the Planned Service Area	13
Source Water Assessments	14
Water Conservation	15
Wastewater	16
The Public Sewer System	16
Outside the Planned Service Area	19
Redevelopment within / Expansion of the Planned Service Area	21
Infrastructure Maintenance	23
<i>Policies and Actions</i>	23
WATER AND RELATED LAND RESOURCES.....	25
Introduction	25
Stormwater Management.....	25

The National Pollutant Discharge Elimination System	27
Stormwater Management Facilities	27
Water Quality in Local Streams	28
Tier II Waters	31
Land Use and Nutrient Load Changes	31
Impervious Cover	33
Development Regulations to Protect Water Resources	34
Watershed Planning and Management	34
Watershed Studies	35
Restoration Projects	36
Best Management Practices	37
Regional Water Resources	38
Total Maximum Daily Loads	39
Patuxent Reservoirs	41
Funding	41
<i>Policies and Actions</i>	42
APPENDIX A: GROWTH PROJECTIONS	45
Introduction	45
Projections	46
Residential Projections	46
Details by Water Pressure Zone and Sewer Service Areas	50
Nonresidential Projections	50
Modifications to the Growth Projections	51
APPENDIX B:	53
NONPOINT AND POINT SOURCE LOADINGS	53
Introduction	53
Land Use and Nonpoint Source Analysis	53
Land Use Change	54
Impervious Cover	57
Point and Nonpoint Source Loadings	60
Modifications to the Nonpoint and Point Source Loadings	61

EXECUTIVE SUMMARY

Water Resources Element

The Water Resources Element (WRE) is an amendment to the General Plan that is required by State legislation passed in 2006. The intent of the WRE is to ensure a safe and adequate supply of drinking water, and adequate land and water capacity for the treatment of wastewater and stormwater, to support future growth.

This Water Resources Element amendment incorporates and updates relevant Policies and Actions from General Plan 2000 and adds new Policies and Actions. These Policies and Actions are intended to help the County meet an overarching goal of managing our water resources more sustainably to ensure that as the County continues to grow, our water resources will be conserved, protected and restored to health. It is critical to ensure the health of our local and regional waters, if we are to restore the Chesapeake Bay.

Growth projections for the Water Resources Element extend to the year 2030 and are based on the General Plan 2000. The WRE projections were modified to address potential requests for new development or redevelopment in Columbia Town Center, the Village Centers and Doughoregan Manor.

Drinking Water and Wastewater

The water for Howard County's public water supply system is purchased from Baltimore City and the Washington Suburban Sanitary Commission (WSSC). More than 95% of the County's public water supply is provided through the Baltimore City Central System and less than 5% is provided by WSSC. The supply of public water is not expected to be a constraint on projected growth and development within the Planned Service Area (PSA) through the year 2030. Outside the PSA, there is generally an adequate supply of good quality groundwater to serve projected demand from individual and community wells.

Source: Versar, Inc.



Although the County only gets 5% of its drinking water from the WSSC reservoirs, about half the reservoirs watershed is in the County.

To manage water resources more sustainably, the County should encourage water conservation, which will also help reduce flows to the wastewater treatment plants. The County should also increase support for the Baltimore and Patuxent Reservoirs interjurisdictional watershed protection efforts, to maintain the high quality of these drinking water supply sources.

Wastewater treatment within the PSA is provided by the Little Patuxent Water Reclamation Plant (WRP), which is owned and operated by Howard County, and the Patapsco Wastewater Treatment Plant (WWTP), which is owned and operated by Baltimore City. The service areas for these plants are largely defined by the natural drainage areas for the Patuxent and

Patapsco Rivers. Capacity at the plants is expected to be adequate to meet projected growth and development within the PSA through the year 2030.

Source: Howard County Public Information Office



The Little Patuxent Water Reclamation Plant treats wastewater for about 70% of the County served by public sewer.

To meet Chesapeake Bay cleanup goals, Maryland has established annual nutrient (nitrogen and phosphorus) loading caps for all major wastewater treatment plants in the State. Once flows at the Little Patuxent WRP exceed the amount used to establish this cap, the plant must maximize treatment to ensure the cap is met. Capacity at the Patapsco WWTP may be reduced once treatment at the plant is upgraded to meet the cap, which may in turn reduce the County's capacity allocation at the plant.

The nutrient caps must be maintained to help restore the health of the rivers and the Bay, into which the plants discharge, while ensuring the County has adequate wastewater treatment capacity to allow continued growth. To help

maintain the nutrient cap at the wastewater treatment plants, development on properties added to the current PSA, large redevelopment sites within the PSA and large sites with zoning intensification within the PSA should minimize increases in flow and the nutrient concentration in flow sent to the plants. This can be achieved through a combination of water conservation and reuse, and on-site treatment of wastewater. In addition, the County should continue to look for opportunities to expand wastewater reuse and investigate options for nutrient trading.

Outside the PSA, County soils are generally capable of supporting individual and shared septic fields. The County should encourage the use of nitrogen reducing treatment for new and upgraded septic systems, to reduce nitrogen loads to groundwater and surface water.

Water and Related Land Resources

The County develops watershed management plans to set priorities and guide efforts to protect, restore and improve the County's water resources. These efforts help the County meet Federal and State requirements to improve water quality. Most water bodies in the County have degraded water quality and habitat for aquatic life, although there are also stream segments with excellent water quality and habitat. The watershed management plans have generated an extensive list of restoration projects that far exceeds the current capital budget for these projects. It is easier and more cost effective to protect high quality resources in a watershed than to allow resources to become degraded and then attempt restoration. To manage water resources more sustainably, the County should strengthen resource protection measures and enhance watershed restoration efforts.

The County should continue to prepare watershed management plans for all County watersheds. The Middle Patuxent River watershed should be a priority for future study, because it is projected to have the largest percentage of the County's future land use change. Watershed management plans should also be expanded to address wetland resources, and establish goals for forest cover and riparian forest buffers.

Development regulations can help protect water resources from impacts caused by development. New State stormwater management regulations increase pollutant removal, groundwater recharge and stream channel protection requirements for new development and redevelopment. Howard County must adopt these new regulations by May 2010. The County should also strengthen buffer requirements to enhance protection of streams, wetlands and floodplains.

EXECUTIVE SUMMARY

Development regulations must be properly implemented and enforced to be effective. The County should ensure there are adequate resources to monitor and enforce development regulations and to effectively educate developers and contractors. The County must also ensure that stormwater management facilities, which will increase significantly in number as a result of the new stormwater management regulations, are inspected regularly and maintained over time.

The majority of land in the County is privately owned, so implementing best management practices (BMPs) on private residential, business and agricultural property is critical to improving water quality and habitat. Current outreach and education efforts should be expanded and new programs initiated to increase BMP implementation on private property. The County can also provide leadership in BMP implementation by incorporating environmentally sensitive site development and property management practices into County activities.

If the County wishes to increase the pace of watershed restoration, expanding outreach and education to increase the implementation of best management practices on private properties, additional funding is needed. The County should institute a dedicated fund to provide increased and sustained funding for the watershed management program, which is anticipated to continue to expand and evolve in response to Federal and State regulatory requirements.



Protecting our rivers, streams and wetlands from degradation is more sustainable than trying to mitigate the damage done to them.

WATER RESOURCES ELEMENT

GENERAL PLAN 2000

General Plan Visions

The central theme for the General Plan 2000 is that we are stewards of the County's social, economic and environmental systems. Six visions for Howard County's future support this central theme and provide a foundation for the Policies and Actions of the General Plan.

- Vision 1:** Our actions will complement State and regional initiatives in resource and growth management.*
- Vision 2:** Our rural lands will be productive and rural character will be conserved.*
- Vision 3:** Our development will be concentrated within a growth boundary, will be served by adequate public facilities and will encourage economic vitality.*
- Vision 4:** Our communities will be livable, safe and distinctive.*
- Vision 5:** Our environmental resources will be protected, used wisely and restored to health.*
- Vision 6:** Our citizens will take part in the decisions and actions that affect them.*

The Water Resources Element

The Water Resources Element is an amendment to the General Plan that is required by State legislation passed in 2006. The intent of the Water Resources Element is to ensure a safe and adequate supply of drinking water, and adequate land and water capacity for the treatment of wastewater and stormwater,

to support future growth. The Water Resources Element must reflect the opportunities and limitations presented by local and regional water resources. It is intended to improve the protection of water resources and to address water resource goals within the context of local and State Smart Growth policies.

Our water resources include our rivers, wetlands, floodplains, lakes, reservoirs and groundwater. These are vital natural resources that provide drinking water, stormwater management, pollution abatement, floodwater storage, transportation and recreation, as well as important habitat for a wide variety of plant and animal species. Water

resources are linked together through the hydrologic cycle, which circulates water from the atmosphere to the land, groundwater and surface water, and then back to the atmosphere. This linkage means that impacts on one resource can have successive impacts on other resources.



Source: MD Office of the Secretary of State

The Chesapeake Bay is an important regional water resource.

The General Plan 2000 contains numerous Policies and Actions related to the protection and restoration of water resources. The Responsible Regionalism chapter addresses cooperation for regional protection of water resources, Preservation of the Rural West addresses groundwater and septic systems, Balanced and Phased Growth addresses the adequate supply of drinking water and wastewater treatment capacity, and Working with Nature addresses environmental stewardship, the protection of streams and wetlands, and stormwater management.

The Working with Nature chapter also contains Policies and Actions related to green space and greenways, as a resource protection network. Green space includes open space, easements, parks and other types of conservation areas. These Policies and Actions provide the basis for green space and greenways planning in the 2005 Howard County Land Preservation, Recreation and Parks Plan.

This Water Resources Element amendment incorporates and updates relevant Policies and Actions from General Plan 2000 and adds new Policies and Actions. These Policies and Actions are intended to help the County meet an overarching goal of managing our water resources more sustainably. This includes protecting and restoring water quality to reduce the treatment costs for drinking water and ensure our waters remain fishable and swimmable, and conserving water to reduce the energy and infrastructure costs associated with water supply and wastewater treatment.

Planned Service Area and Priority Funding Area

A significant policy decision in Howard County General Plans since the 1970s was the division of the County into an eastern, urban development area, which would have public water and sewer service, and a less densely developed Rural West, which would not. The Planned Service Area (PSA) in the Master Plan for Water and Sewerage corresponds to the urban development area.

The boundary of the Planned Service Area is Howard County's growth boundary. This identification was strengthened by Maryland's 1997 Smart Growth initiatives under which most categories of State spending for infrastructure and services must be targeted to "Priority Funding Areas" in each County. Howard County's Priority Funding Area is the eastern 40% of the County that lies within the Planned Service Area for both public water and sewerage. The PSA has changed little since 1979, demonstrating the County's commitment to growth management.

Agriculture is the preferred land use in the Rural West. Zoning for the west allows low density residential development, which can be more economically served by individual wells and septic systems. Consequently, this part of the County is designated as the No Planned Service Area.

In July 1993, the County Council voted to extend the PSA to include the area around the Alpha Ridge Landfill. This extension was done solely to address citizen concerns about potential groundwater contamination originating from the Alpha Ridge Landfill, therefore, only water service is provided in this area. In 2006, the County Council voted to allow the provision of sewer service in the Alpha Ridge Water Service Area to provide public services on qualifying government owned parcels. Qualifying parcels are parcels owned by Howard County or the Board of Education, that adjoin another parcel where sewer service is available. Sewer service may be extended to a qualifying parcel only if sewer service can be extended without making the service available to any intervening non-qualifying parcel.

Generally, an extension to the PSA is allowed only if the proposed expansion is part of a proposed zoning and is consistent with the General Plan and Smart Growth policies or for public or institutional uses provided that such an extension is limited to the minimum parcel size necessary to serve the proposed use. In 2006, the County Council voted to limit expansions of the PSA for public or institutional uses to

properties adjoining the existing boundary of the PSA, excluding any intervening privately owned parcels not currently located in the PSA.

Figure 1 shows the General Plan 2000 Policies Map, which includes the PSA boundary.

Growth Projections

Growth projections for the Water Resources Element are based on the General Plan 2000. In Chapter 4, Balanced and Phased Growth, the General Plan 2000 sets allowed annual levels of new residential units by planning area. Using these allowed annual levels, the growth in housing units is projected, then population is estimated based on persons per housing unit and occupancy factors. Since General Plan 2000 is a 20-year plan, the growth projections for the Water Resources Element extend beyond 2020 to the year 2030. The same general pace of growth is assumed between 2020 and 2030, although

development slows as developable land becomes more scarce in the out years.



Growth projections include potential redevelopment of Downtown Columbia.

Growth projections for the Water Resources Element were developed in 2008 and are based on a modified version of Round 7a of the Baltimore Metropolitan Council Cooperative Regional Forecast. The Round 7a projections were modified to address the following potential proposals during development of the Water Resources Element.

- A General Plan amendment to request additional population and commercial square footage for the redevelopment of Downtown Columbia.
- A General Plan amendment to request an extension of the PSA to allow limited new residential development on a portion of Doughoregan Manor as part of a comprehensive strategy to protect this National Historic Landmark property.
- Requests for additional population and commercial square footage for the redevelopment of the Columbia Village Centers, as may be permitted under the New Town zoning district.

In 2007, Howard County's household population was 276,263. Based on Round 7a projections, as modified above, the population is expected to grow to almost 330,000 by 2030. This is an increase of about 53,600 residents or a 19% increase over the 23-year projection period. The majority of this growth (80%) will occur inside the Planned Service Area.

In 2005, commercial land use in the County totaled just over 3,500 acres. Based on Round 7a projections, as modified above, this is expected to increase to just over 4,700 acres in 2030. The majority of this acreage (90%) will be located inside the Planned Service Area.

All discussions of projected growth, including land use changes, in the Water Resources Element used the Round 7a projections as modified above. Appendix A provides additional information on the growth projections for the Water Resources Element.

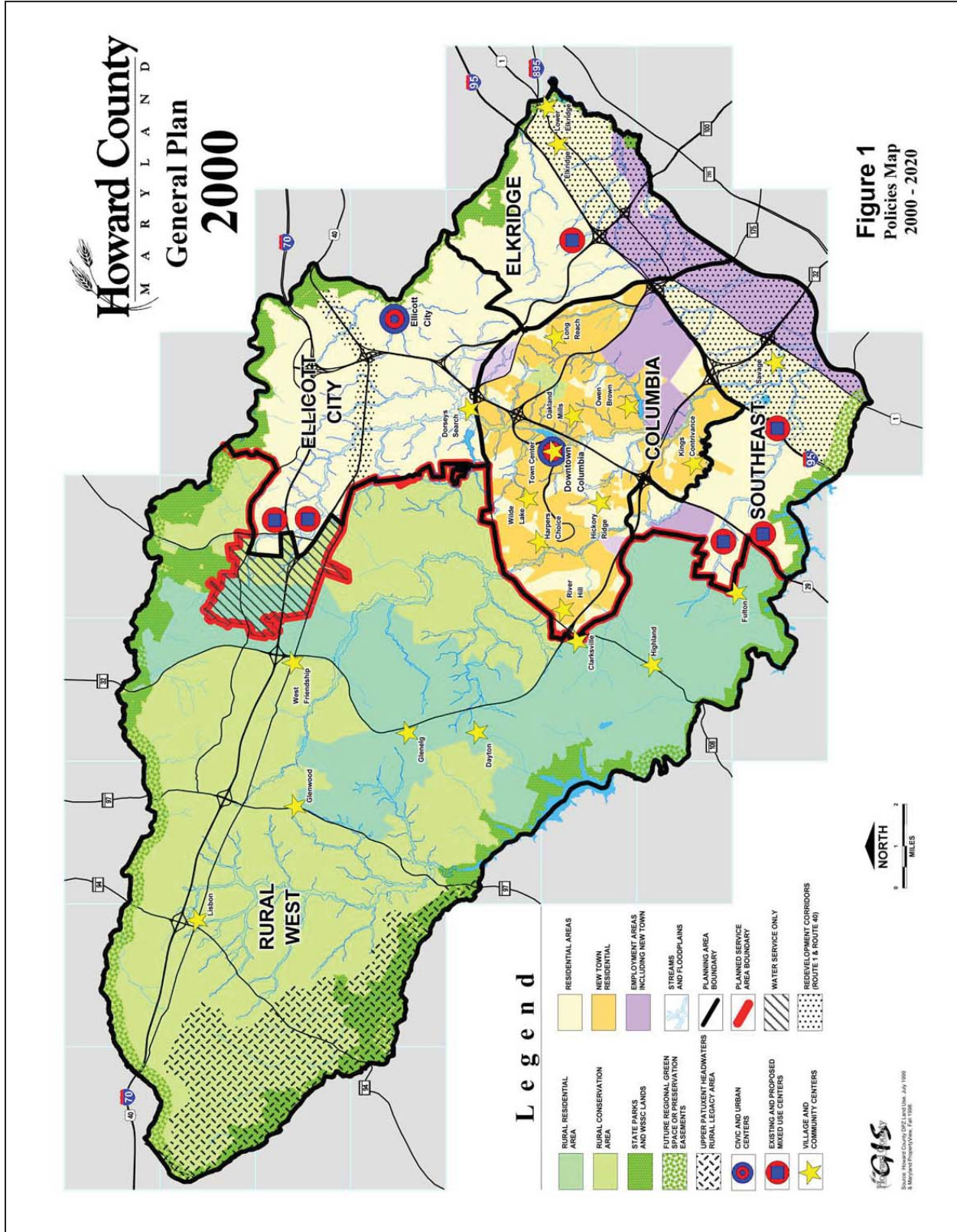

Figure 1: General Plan 2000 Policies Map

DRINKING WATER AND WASTEWATER

Introduction

Approximately 86% of the County's population is served by the public water and sewer system and the remaining 14% of the population is served by individual wells and individual and shared septic systems. In 2030, approximately 85% of the County's population will be served by the public system.

The pace of residential and employment growth in the County is directly related to the need for additional water and wastewater service. It is important to maintain a growth rate that does not exceed the capacity of the Baltimore City and Washington Suburban Sanitary Commission (WSSC) water supply systems and the Little Patuxent and Patapsco wastewater treatment plants that serve eastern Howard County.

The Provision of Public Water and Sewer Services

The County schedules the provision of water and sewer facilities in the Master Plan for Water and Sewerage (the Master Plan). This Water Resources Element incorporates by reference the Master Plan for Water and Sewerage adopted by the County Council on October 6, 2008. The Master Plan and any proposed amendments must be reviewed by both the Department of Planning and Zoning and the Maryland Department of Planning for consistency with the General Plan before being adopted by the County and approved by the Maryland Department of the Environment. Under State law the Master Plan must be updated every three years.

The Master Plan establishes and delineates the Planned Service Area (PSA) and identifies the remainder of the County as the No Planned Service Area. For capital project planning and the orderly extension of facilities, the Master Plan delineates service priority areas within the PSA as existing and under construction, 0-5 years, 6-10 years, and comprehensive (beyond 10 years). Construction of water and sewer facilities requires a State permit, which may only be obtained if a property is within the 0-5 years service priority area.

Prior to the provision of public water or sewer service, a property must be included in the PSA and must enter the County's Metropolitan District. All properties in the current Metropolitan District are in the PSA, but not all properties in the current PSA are in the Metropolitan District. All properties in the Metropolitan District are subject to fees, assessments and charges, which are dedicated to the Enterprise Fund, which pays for the construction, operation, maintenance and administration of the public water and sewer system.

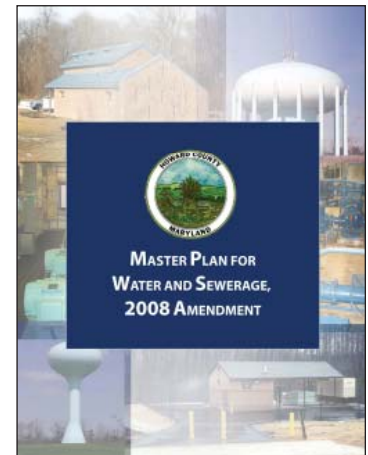

Source: Department of Public Works

The current Master Plan for Water & Sewerage was adopted by the Howard County Council in 2008.

At times, a developer may want service to a property earlier than specified by the Master Plan and is willing to construct planned facilities in advance of the County capital project construction schedule. If the proposed development is an orderly extension of the system and is consistent with the General Plan and subdivision regulations, the County grants the service priority area change so development can occur. The request for a change in service priority area is made with the initial development plan submittal. These service priority area changes are reflected in the twice yearly update of the Master Plan.

The State mandates that local authorities may not issue building permits unless the water supply and sewer systems are adequate to serve the proposed development, taking into account all existing and approved developments within the service area. In addition, local authorities may not record or approve a subdivision plat unless water and sewer systems will be adequate and complete in time to serve the proposed development. In Howard County, water and sewer capacity is formally allocated to development at the end of the subdivision or site development plan review process.

Through the self-sustaining Enterprise Fund, the County pays the construction costs for major facilities in the public water and sewer system and the developer pays the cost for the system extension to their individual development. Orderly expansion of the public water and sewer system is controlled through the County's Capital Budget and Ten-Year Capital Improvement Program, the Metropolitan District entry process, the development plan review process, and the Water and Sewer Capacity Allocation Program.

What are the four most critical uses for public water?

- ❖ Fire protection and suppression (public safety).
- ❖ Flushing away waste (public health).
- ❖ Cooling critical equipment and computers.
- ❖ Drinking water and wash water.

Drinking Water

The Public Water System

The water for the County's public water supply system is purchased from Baltimore City and WSSC, through a series of negotiated legal agreements. More than 95% of the County's public water supply is provided through the Baltimore City Central System and less than 5% is provided by WSSC.

Source: Department of Public Works



Howard County has nine water storage tanks within the Metropolitan District.

In addition to supplying water to Baltimore City and Howard County, the Central System also provides water to Anne Arundel, Baltimore, Carroll and Harford Counties. Howard County has several water supply agreements with Baltimore City and Baltimore County. These agreements specify the water supply through four physical connections to the Baltimore County system – one at Elkridge, two along Route 40 and one at Gun Road (also in Elkridge).

The Central System's primary water sources include Loch Raven, Prettyboy and Liberty Reservoirs, with the Susquehanna River as a backup source. The watersheds for the Baltimore system reservoirs lie primarily within Carroll and Baltimore Counties.

In addition to supplying water to Howard County, WSSC also provides water to Montgomery and Prince George's Counties. Water sources for WSSC are the Triadelphia and Rocky Gorge Reservoirs along the

Patuxent River, and the Potomac River. The watersheds for the Patuxent Reservoirs lie primarily within Howard and Montgomery Counties.

Howard County’s water system is currently divided into eight pressure zones, as shown in Figure 2. An additional ninth water pressure zone is currently under development in the southern portion of the County for the Hammond Branch Extended area. This area is located west of US 29 between MD 216 and Johns Hopkins Road. The water from WSSC is normally used in the County’s water pressure zone located east of I-95 between Laurel and Jessup.

Baltimore City’s 2003 Central System Report and 2006 Comprehensive Water and Sewer Plan outline the required improvements to the Central System through the year 2025. A future Central Water Supply System Agreement between Baltimore City, Baltimore County, Anne Arundel County and Howard County will identify the additional water supply facilities needed to provide for projected growth in the Baltimore metropolitan service area and will specify construction schedules, cost shares, water demands and flow limitations.

As shown in Figure 3, current average daily use for the County’s public water system is 22.4 million gallons per day (mgd). Under current agreements, the allowable average daily flow from the Baltimore Central System and WSSC is approximately 41.5 mgd. The multiple connections and excess capacity in this supply system gives the County flexibility, should flows be reduced or unavailable through any one connection. If needed, the County system can also pump water from WSSC to other areas of the County, and water from Baltimore City can be substituted for water from WSSC.

The current agreement with WSSC provides for additional capacity, if requested by Howard County and approved by WSSC. The County is currently negotiating with WSSC for this additional capacity, to take advantage of the closer access to WSSC water. Access to this additional capacity would require distribution system improvements by WSSC and Howard County.

As shown in Figure 3, projected average daily use in 2030 is 29.1 mgd and allowable average daily flow is approximately 46.5 mgd. The projected use of water from WSSC in 2030 is maximized to take advantage of the closer access to WSSC water. If the increased flow from WSSC is not available, water from Baltimore City can be substituted. Therefore, the supply of water is not expected to be a constraint on projected growth and development within the Planned Service Area through the year 2030.

Why drink public water rather than bottled water?

- ❖ Public water must meet higher standards for purity than bottled water.
- ❖ Public water is cheaper than bottled water.
- ❖ Bottled water requires considerable energy to produce and distribute.
- ❖ Bottled water results in large quantities of refuse that must be recycled or disposed of.

Figure 3: Allowable Water Supply and Use

Source	Current		2030	
	Average Daily Use (mgd)	Average Daily Flow (mgd)	Projected Average Daily Use (mgd)	Planned Average Daily Flow
Baltimore City	20.9	38.5	21.6	38.5
WSSC	1.5	3.0	7.5	8.0
Total	22.4	41.5	29.1	46.5

Source: DPW 2008 and 2008 Master Plan for Water and Sewerage
 Note: Current use based on FY2008 water purchase records.

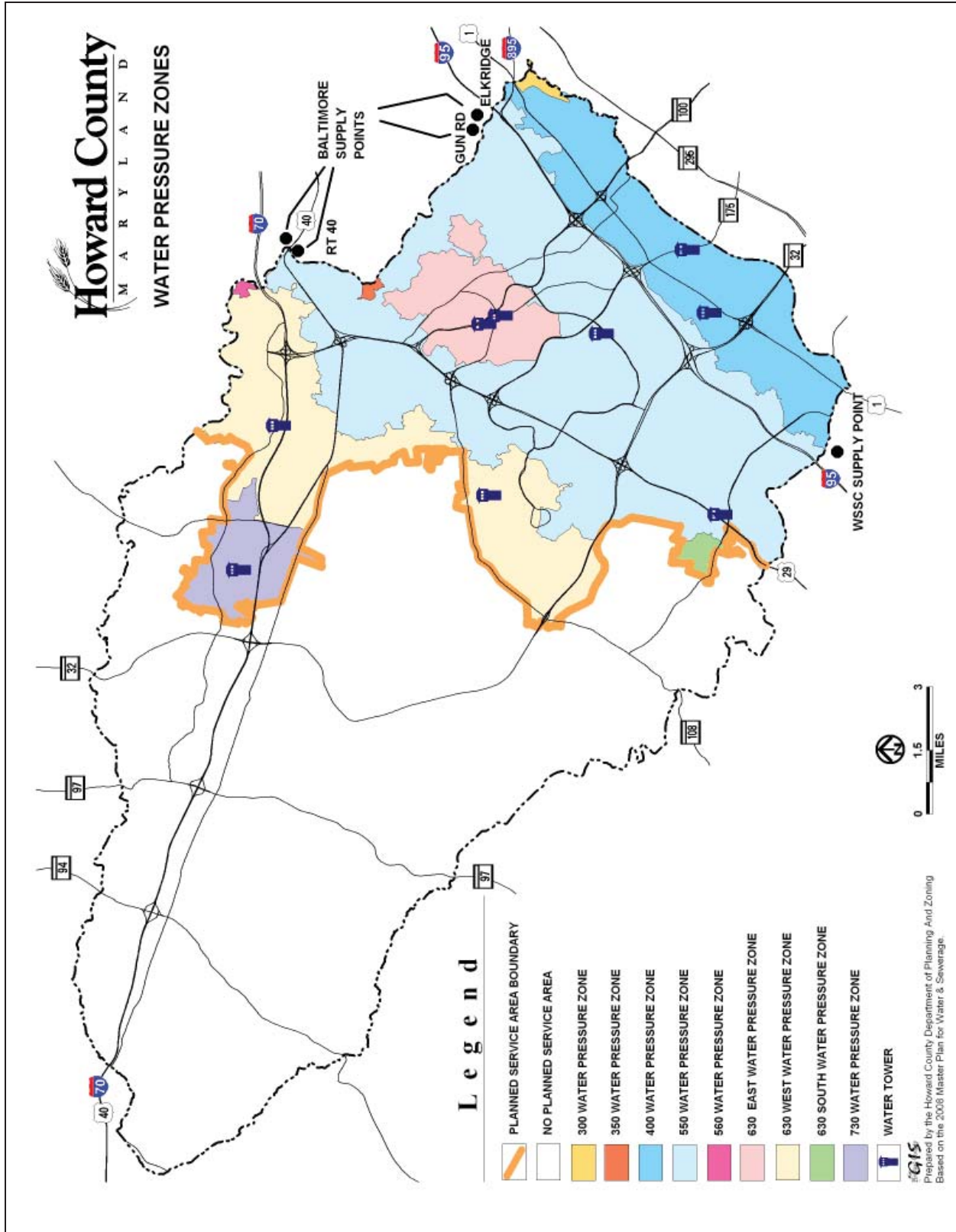

Figure 2: Water Pressure Zones Map

Outside the Planned Service Area

Groundwater is the major source of potable water where public water service is not available. The most recent study of groundwater quality and yield in the County is Water Resources of Howard County, Maryland, published by the Maryland Geological Survey in 1995 as Bulletin 38. Overall groundwater quality is generally good, however, most of the water is somewhat acidic.

Howard County lies within two physiographic provinces, the Piedmont and Coastal Plain provinces. The Fall Zone forms a boundary between the two provinces and runs in a northeast to southwest direction roughly parallel with I-95. The majority of the County (90%) lies within the Piedmont province. In the Piedmont, groundwater is found in the joints and fractures of the crystalline rock formations. In the Coastal Plain, groundwater is found in the intergranular spaces of unconsolidated sediments. The vast majority of wells in the County are in the Piedmont province.

There is generally an adequate supply of good quality groundwater within these formations to serve projected ultimate development demand outside the PSA even under drought conditions. However, this is a regional analysis that does not address individual well conditions. The ability to locate and tap groundwater in the Piedmont may vary significantly with well location, because groundwater is stored in and travels through a network of fine cracks and fissures in the bedrock aquifer.

The withdrawal of water from surface and groundwater supplies is regulated by the Maryland Department of the Environment (MDE), through the issuance of Water Appropriation Permits. Small water users such as individual residences and agricultural users of less than 10,000 gallons per day are exempt from permit requirements. Permit applications are reviewed to ensure that the quantity requested is available and reasonable, that the withdrawal will not affect downstream or other users, and that the withdrawal will not impact the resource. Examples of impacts to the resource that the permitting system is intended to prevent include withdrawal from groundwater that exceeds the recharge rate of the aquifer or withdrawal from a stream that reduces flows to the point that aquatic life in the stream is harmed.

The fractured-rock aquifers of the Piedmont are generally more susceptible to contamination than the Coastal Plain aquifers. There are a few well contamination problems in various unrelated areas outside the PSA. Currently, two subdivisions are experiencing well contamination problems with excess nitrates. These problems are being addressed by the property owners with individual water quality treatment devices. In addition, Lisbon is experiencing well contamination problems with gasoline and solvents, excess nitrates and bacteriological (coliforms). MDE is providing carbon treatment on several sites and other problems are being addressed by the property owners with individual water quality treatment devices.

Radium and radon are radioactive elements found naturally occurring in the Baltimore Gneiss geologic formation that underlies a significant area in central Howard County. The Health Department has done extensive testing of wells within this formation, and both elements have been detected. Property owners with elevated levels have been advised to install treatment devices and the Health Department has done follow up testing to confirm the treatment is functioning properly.



Source: Health Department

The Health Department's Bureau of Environmental Health is responsible for review and approval of private wells in the County.

Source Water Assessments

The Federal Safe Drinking Water Act Amendments of 1996 require source water assessments (SWA) for public water supplies. The SWA evaluates the susceptibility of the public water supply source to various contaminants and contains recommendations to protect the source from these contaminants. Source water assessments are designed to promote local, voluntary source water protection programs.

In Howard County, SWAs were developed from 2003 to 2005, for water supply systems that serve 25 or more individuals. This included the Baltimore and Patuxent Reservoir systems, and 76 well systems for facilities such as shopping centers and schools. The SWAs found that each system assessed provides drinking water that meets Safe Drinking Water Act standards, but each system is susceptible

to one or more contaminants. In general, the SWA recommendations to reduce this susceptibility are to maintain and strengthen existing protection and monitoring efforts.

Reservoir Systems

The SWAs for the Baltimore and Patuxent Reservoirs recommended limiting nonpoint source pollution to the reservoirs, especially runoff from suburban and agricultural land uses in the watersheds. The SWAs deferred to the Total Maximum Daily Loads (TMDLs), a requirement of the Federal Clean Water Act, to quantify the needed pollutant reductions. The TMDL for the Patuxent Reservoirs is discussed in the Water and Related Land Resources section, under the Total Maximum Daily Loads topic.



The Baltimore Reservoirs, which provide a majority of Howard County's drinking water, are the subject of an interjurisdictional watershed protection agreement.

The Baltimore Reservoirs and the Patuxent Reservoirs are both subjects of interjurisdictional watershed management and protection agreements. Signatories to the Baltimore Reservoirs Agreement include Carroll and Baltimore Counties, the Carroll and Baltimore County Soil Conservation Districts, Baltimore City, and the Maryland Departments of Agriculture and the Environment. Signatories to the Patuxent Reservoirs Watershed Protection Agreement include Howard, Montgomery and Prince George's Counties, WSSC, the Howard and Montgomery County Soil Conservation Districts, and the Maryland-National Capital Park and Planning Commission. The Baltimore Reservoirs Agreement was signed in 1984 and the Patuxent Reservoirs Watershed Protection Agreement was signed in 1996. As a customer of the Baltimore water supply system, Howard County participates in the Baltimore Reservoirs Agreement. Howard County is a signatory to the Patuxent Reservoirs Agreement, because the County contains just over half of the watershed for this system.

Signatories to these agreements are working together to protect and improve the quality of the water flowing to these reservoirs. The Baltimore Reservoirs effort is guided by an Action Strategy and the Patuxent Reservoirs effort is guided by a Priority Resource Protection Program. (More information about the priority resources is given in the Water and Related Land Resources section, under the Patuxent Reservoirs topic.) Ongoing activities include the implementation of best management practices such as agricultural nutrient management, stream buffer plantings, stream channel stabilization, and stormwater retrofits for the control of nonpoint source pollution from agricultural and developed land, water quality monitoring in watershed streams and the reservoirs, and outreach and education to encourage environmental stewardship among those living, working and recreating in the watershed.

The reservoir protection agreements and the work done under them will help Baltimore City and WSSC, as water suppliers, and the jurisdictions within the reservoir watersheds implement the recommendations of the source water assessments. However, addressing nonpoint sources of pollution from developed and agricultural land uses requires adequate and sustained funding and private landowner cooperation. Both reservoir protection programs would benefit from increased funding and support.

Well Systems

The SWAs for the well systems recommended a number of protection measures to address potential point and nonpoint sources of contamination. Potential point sources of contamination include underground storage tanks, controlled hazardous substance generators (such as dry cleaning operations) and groundwater discharges associated with commercial areas. Nonpoint sources of contamination include agricultural land, commercial land and private septic systems.

To ensure the safety of these well systems, monitoring is conducted on a regular basis by the Health Department or the system owner and the results are reported to MDE. Education for system owners is part of this monitoring process. The Health Department also mails information regularly on the need for routine well testing to private residential and nonresidential property owners with wells.

What can each of us do to conserve water?

- ❖ Install low flow toilets, faucets and showerheads
- ❖ Take shorter showers and turn off the water while brushing teeth, shaving, etc.
- ❖ Use a water saving dishwasher and clothes washer, and only run full loads.
- ❖ Do not water lawn.
- ❖ Use rain barrels to capture rain water for watering lawns and gardens.
- ❖ Plant native plants that do not require regular watering.

Water Conservation

Clean, safe drinking water is a valuable resource that should be used as wisely as possible. Potable water is currently used to flush our toilets, water our lawns and gardens, and wash our cars, when nonpotable water would suffice. The State requires low flow toilets and showerheads in all new residential construction and per capita water consumption has been decreasing in the County since 2000, primarily as a result of these fixture requirements. Additional water conservation in our homes, gardens and businesses would help the County manage water resources more sustainably and reduce flows to wastewater treatment facilities.



Cisterns at the Chesapeake Bay Foundation collect rainwater for nonpotable indoor uses.

Public outreach and education, as well as financial incentives, can encourage increased water conservation by residents and businesses. Relatively easy conservation measures include using rain barrels to collect rainwater for outdoor watering and washing, replacing lawns with native plants that require less watering, and installing water conserving fixtures and appliances. More complex measures include using cisterns to collect rainwater for indoor nonpotable uses and reusing greywater. Greywater reuse or recycling takes water from washing machines, sinks and bathtubs for nonpotable uses such as flushing toilets and irrigation. Rainwater harvesting and greywater reuse for nonpotable indoor uses have been discouraged or prohibited due to human health concerns. Building codes and regulations should be reviewed and modified

where necessary to remove impediments for retrofitting existing and building new homes and businesses with water conservation and reuse practices and technology.

Wastewater

The Public Sewer System

The public sewer system is divided into two main service areas, as shown in Figure 4. The service areas are largely defined by the natural drainage areas for the Patuxent and Patapsco Rivers, which allows sewage to flow by gravity to the wastewater treatment plants located at lower points along each river.

The Patuxent Service Area includes the Columbia and Savage areas of the Metropolitan District, along with the Route 108 Pumping Station Service Area. The Patapsco Service Area covers the remainder of the Metropolitan District, including the Ellicott City and Elkridge areas. The Route 108 Pumping Station Service Area is a large sub-service area that provides system flexibility. This area is north of MD 108 and west of US 29 and is geographically part of the Patuxent Service Area. If needed, the Route 108 Pumping Station gives the County the option of diverting flow from this area to the Patapsco Service Area.



Source: Howard County Public Information Office

The Little Patuxent WRP, located in Savage, is owned and operated by Howard County.

The Patuxent Service Area flows are treated by the Little Patuxent Water Reclamation Plant (WRP), which is owned and operated by Howard County. The Little Patuxent WRP discharges approximately four miles downstream of the plant to a point below the Fort Meade water intake on the Little Patuxent River in Anne Arundel County. The Patapsco Service Area flows are treated by the Patapsco Wastewater Treatment Plant (WWTP), which is owned and operated by Baltimore City. The Patapsco WWTP discharges into the Patapsco River in the Baltimore Harbor. The County's share of capacity and operating and capital costs for the Patapsco WWTP are determined by formal agreements with three other jurisdictions – Baltimore City, Baltimore County and Anne Arundel County.

Increases in treatment plant capacity through the expansion of existing plants or the addition of new plants are controlled by National Pollutant Discharge Elimination System (NPDES) permits issued by the Maryland Department of the Environment in accordance with Federal Clean Water Act requirements. These permits consider the impact wastewater treatment plant discharges will have on the water quality and downstream uses of the receiving stream. If the increase in discharges will limit downstream uses of the stream, pollution offsets may be necessary and, if this is not possible, permits can be denied. In addition, downstream users of a stream can present legal challenges to permits for treatment plant expansions if the expansion threatens to limit their use of the stream.

As part of Maryland's commitment to meet Chesapeake Bay cleanup goals established in the Chesapeake 2000 Agreement, annual nutrient (nitrogen and phosphorus) loading caps have been established for all major (design capacity greater than 0.5 mgd) wastewater treatment plants in the State. These nutrient loading caps are enforced through the NPDES permit for the plant. The NPDES permit for the Little Patuxent WRP currently has an annual nutrient loading cap that is based on a plant design capacity of 25 mgd and the use of Enhanced Nutrient Removal (ENR), a biological treatment process.

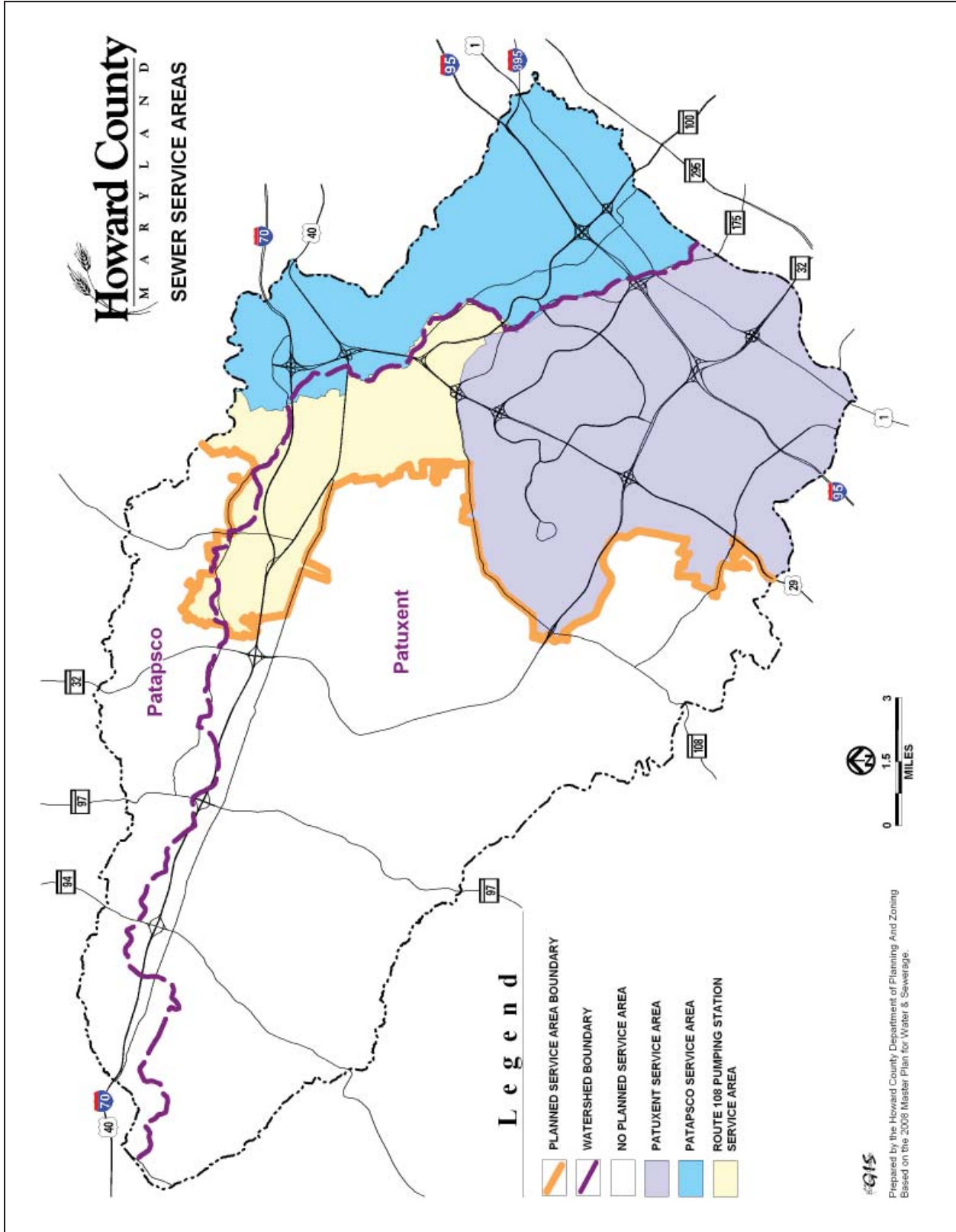

Figure 4: Sewer Service Areas Map

When ENR treatment is operating at maximum efficiency, an effluent nutrient concentration of 3.0 milligrams per liter (mg/L) or less total nitrogen and 0.3 mg/L or less total phosphorus can be achieved. However, since ENR relies on biological processes, this effluent concentration may be difficult to achieve in the winter when cold weather slows these processes, especially for nitrogen. To provide a margin of safety for nitrogen in the NPDES permit, the nutrient loading cap is based on an annual average concentration of 4.0 mg/L total nitrogen and an annual average concentration of 0.3 mg/L total phosphorus. This generates an annual nutrient loading cap for the Little Patuxent WRP of 304,556 lbs of nitrogen and 22,842 lbs of phosphorus.

As shown in Figure 5, the Little Patuxent WRP has a current capacity of 25.0 mgd and the current County usage is 18.7 mgd. This capacity will meet County needs through 2015. The County is currently expanding plant capacity to 29.0 mgd and adding ENR treatment at the plant. Construction began in 2009 and is expected to be completed in 2012. The projected usage at the plant in 2030 is 26.9 mgd.

Once flow at the Little Patuxent WRP exceeds 25 mgd, the NPDES permit will require an annual average nutrient concentration of 3.45 mg/L total nitrogen and 0.25 mg/L total phosphorus. This is based on a reduction of the nutrient cap concentrations by a ratio of 25/29. To achieve these reduced nutrient concentrations as flow increases from 25 to 29 mgd, the plant must be running at a higher efficiency for ENR treatment for a longer time each year.

Figure 6 presents the current and future annual nutrient loads for the Little Patuxent WRP. The current load is based on an annual average concentration in the discharge of 5.3 mg/L total nitrogen and 0.4 mg/L total phosphorus. The projected 2030 load is based on an annual average concentration of 3.45 mg/L total nitrogen and 0.25 mg/L total phosphorus. The addition of ENR treatment will decrease annual nitrogen loads by 6.4% and decrease annual phosphorus loads by 11.4%, even with increased flows, and keep the plant under its nutrient loading cap.

The expansion of the Little Patuxent WRP will use the entire parcel on which the plant is currently located. The County also owns an adjacent parcel that could be used for future expansions or treatment improvements, if needed.

The Patapsco WWTP has a current capacity of 73 mgd and the current County share of this capacity is 10.0 mgd. As shown in Figure 5, current usage by the County is approximately 6.6 mgd. Sewage flows in the Patapsco Service Area are projected to be 10.2 mgd by 2030. The Patapsco WWTP is currently adding ENR facilities and expanding capacity to 81 mgd. Construction began at the end of 2009 and is expected to be completed in 2012. The County share of this new capacity is projected to be 11.0 mgd.

The Patapsco WWTP also has an annual nutrient cap that is based on a plant design capacity of 73 mgd and the use of ENR treatment. This generates an annual nutrient loading cap for the plant of 889,304 lbs of nitrogen and 66,698 lbs of phosphorus. If Howard County's portion of this cap is based on the current County share of capacity at this plant, this generates an annual nutrient loading cap for County usage of 121,822 lbs of nitrogen and 9,137 lbs of phosphorus. The addition of ENR treatment may reduce future capacity at the plant, because this plant has no additional land available for expansion, and ENR treatment requires additional space and treatment time. If plant capacity is reduced, this may in turn reduce the County's capacity allocation at the plant. Capacity at the plant will be determined after the ENR addition is completed and a new NPDES permit is issued.

Figure 6 presents the current and future annual nutrient load from Howard County usage at the Patapsco WWTP. The current load is based on an annual average concentration in the discharge of 19.46 mg/L total nitrogen and 1.16 mg/L total phosphorus. The projected 2030 load is based on an assumed annual

average concentration of 3.60 mg/L total nitrogen and 0.27 mg/L total phosphorus. This is based on a reduction of the nutrient cap concentrations by a ratio of 73/81. The addition of ENR treatment will decrease annual nitrogen loads by 71.4% and decrease annual phosphorus loads by 64.0%, even with increased usage by Howard County.

The total currently planned treatment capacity of 40.0 mgd will satisfy the County’s projected needs of 37.1 mgd in 2030, while maintaining the nutrient load limits at the plants. However, a question remains about a possible decrease in capacity at the Patapsco WWTP, due to the ENR upgrade and nutrient cap.

Figure 5: Wastewater Treatment Plant Capacity and Use

Treatment Plant	Current		2030	
	Average Daily Use (mgd)	Capacity (mgd)	Projected Average Daily Use (mgd)	Planned Capacity (mgd)
Patapsco	6.6	10.0	10.2	11.0
Little Patuxent	18.7	25.0	26.9	29.0
Total	25.3	35.0	37.1	40.0

Source: DPW 2008; 2008 Master Plan for Water and Sewerage; 2007 flows for current usage.

Figure 6: Wastewater Treatment Plant Nutrient Loads

Treatment Plant	Current Usage (mgd)	Current Nutrient Load (lbs/year)		2030 Usage (mgd)	2030 Nutrient Load (lbs/year)		Nutrient Cap (lbs/year)	
		Nitrogen	Phos.		Nitrogen	Phos.	Nitrogen	Phos.
Little Patuxent	18.7	301,701	22,770	26.9	282,508	20,167	304,556	22,842
Patapsco	6.6	390,972	23,306	10.2	111,779	8,383	121,822	9,137

Source: Howard County DPW 2008 and Baltimore City DPW 2010; 2008 Howard County Master Plan for Water and Sewerage; 2007 flows for current usage.

Outside the Planned Service Area

Outside the Planned Service Area, wastewater treatment is provided by individual and shared septic systems. In general, County soils are capable of supporting septic fields throughout the Rural West. Lisbon is the only problem area, due to small lot sizes, marginal soils in some areas and old systems. The County evaluated Lisbon for well and septic concerns and proposed a shared septic system in 2008; however, residents were not supportive of the proposal. Some of the problem lots may need holding tanks if suitable repair areas are not available. The Health Department also receives reports on a small number of individual failing septic systems in other areas of the County. Repairs to these systems are based upon the individual property conditions and available septic repair area.

The General Plan 2000 recommends the use of shared septic systems for cluster subdivisions, to protect groundwater and agricultural lands in the Rural West. Generally, soils that are well suited for septic systems are also well suited for agriculture. With a shared septic system, the common drain field is placed



Septic systems provide wastewater treatment outside the Planned Service Area.

on optimum soils and the individual septic tanks remain on individual lots. This allows homes to be located in areas that are marginally or poorly suited for agriculture.

Shared septic systems are owned, operated and maintained by the County, and maintenance costs are financed by the system users. The Master Plan for Water and Sewerage lists 29 existing or planned shared septic systems in the County. Nine of these systems are large enough (with design flows over 10,000 gallons per day) to require an MDE groundwater discharge permit. Because the maintenance cost per house is very high for large systems, the County no longer allows any new, large systems requiring an MDE permit after 2004, or, if

owned by the Howard County Board of Education, after 2006.

The Master Plan also lists one private community and five institutional WWTPs with subsurface discharge outside the PSA. The Howard County Public School System owns three of these institutional plants.

Limiting the amount of nitrogen discharged to groundwater by individual on-site septic systems is a water quality concern. Excess nitrogen in groundwater limits the use of groundwater as a water supply source. Additionally, since groundwater is a source of base flow in streams, excess nitrogen in groundwater can also contribute to nutrient enrichment problems in streams and the Chesapeake Bay.

A variety of on-site treatment technologies have been developed to reduce the amount of nitrogen discharged from septic systems, and MDE has a list of approved manufacturers and treatment units for nitrogen reducing septic systems. Other local jurisdictions have approved, and in some areas required, the use of nitrogen reducing septic systems for replacement and new septic systems. Nitrogen reducing septic systems provide substantially better treatment, but they cost significantly more than a standard system and have ongoing operation and maintenance costs.

As part of Maryland's commitment to meet Chesapeake Bay cleanup goals, Maryland developed Tributary Strategy plans to reduce nutrient and sediment loads from each major tributary to the Chesapeake Bay. These Tributary Strategy plans include reduction strategies for nitrogen discharges to groundwater from on-site septic systems. The Tributary Strategy plans call for all new (as of 2006) septic systems to be nitrogen reducing systems, and for retrofits of all existing conventional septic systems with nitrogen reducing technology or for these systems to be connected to a wastewater treatment plant. In 2009, the State passed legislation that requires all new or replacement septic systems in the Chesapeake Bay and Coastal Bays Critical Areas use nitrogen reducing technology. Future State regulations may require nitrogen reducing technology for new and upgraded septic systems in additional areas of the State or Statewide.

Maryland's new Chesapeake Bay 2010 Restoration Fund has grant funds available for the addition of nitrogen reducing systems for existing septic systems. The priority area for these funds is the Chesapeake Bay and Coastal Bays Critical Areas. Recently, due to a surplus of funds, MDE made the funds available on a Statewide basis and Howard County residents applied for them. Most of this surplus has now been allocated. The County should make information about the CB 2010 grant funds more widely available to

residents when the funds are available on a Statewide basis, to encourage greater voluntary participation in the program. The County could also provide financial incentives such as tax credits to encourage the use of nitrogen reducing treatment for new and upgraded septic systems.

Nitrogen reducing septic systems require regular inspection and maintenance to ensure proper operation. As these systems become more numerous, the County should investigate options to establish a long-term inspection and maintenance program.

Redevelopment within / Expansion of the Planned Service Area

The water and sewer systems in Howard County have been designed based on projected growth as permitted by zoning and the limits of the Planned Service Area, as the PSA was designated in the General Plan and the Master Plan for Water and Sewerage at the time of the system design. Growth projections developed in 2008 for the redevelopment of Columbia Town Center and the Village Centers, and the development of a portion of Doughoregan Manor create an increased water and sewer service demand within the PSA. This increase is within the projected capacity of the water supply and sewage treatment system, however, the development of a portion of Doughoregan Manor will require an expansion of the current PSA. The development for Doughoregan Manor will not require any resizing of the water delivery system, but will require the advancement and construction of a capital project, currently in the capital budget, to provide adequate capacity in the sewage collection system.

Consideration of bringing a portion of Doughoregan Manor into the PSA is premised on permanent preservation of most of this National Historic Landmark property. It is not intended to signal the potential for inclusion of any other properties with existing or proposed multi-use septic systems adjacent to the PSA. Including additional properties would further increase flow to the Little Patuxent WRP and increase

the need to achieve higher efficiency ENR treatment. Wastewater treatment should be provided within the Patuxent Service Area to minimize increases in flow and the nutrient concentration in flow sent to the Little Patuxent WRP from expansion of the PSA for Doughoregan Manor.

Any future redevelopment within the PSA or extension of the PSA westward, beyond that currently projected, could require further improvements to the wastewater treatment system. These improvements could include: adding parallel collection lines, increasing capacity at existing pumping stations and adding pumping stations. Additionally, such redevelopment or new development may also require more capacity than the County has available under current NPDES nutrient cap limits and/or interjurisdictional agreements. Development on properties added to the

current PSA, large redevelopment sites within the PSA and large sites with zoning intensification within the PSA should minimize increases in flow and the nutrient concentration in flow sent to the wastewater treatment plants. This can be achieved through a combination of water conservation and reuse, and wastewater treatment and the use of reclaimed water.

The nutrient loading caps for the Little Patuxent WRP and the Patapsco WWTP may be further reduced in the future to accommodate cleanup plans mandated under the Federal Clean Water Act for the Patuxent River, Patapsco River and Chesapeake Bay. An additional concern for the nutrient caps is that the effluent nutrient concentration is currently based on an annual average, but there is discussion by the regulatory



Wastewater pretreatment, such as at this industrial facility on US 1, can help reduce flow and nutrient concentration in flow sent to wastewater treatment plants.

Source: Department of Public Works



Source: Illinois Institute of Technology
Wastewater reuse for irrigation can help reduce discharges from wastewater treatment plants.

agencies of moving to a monthly average. A monthly average would be more difficult to achieve at higher flows in the colder months when the biological treatment process is slowed.

Two options available to reduce nutrient discharges from wastewater treatment plants are wastewater reuse and nutrient trading. Wastewater reuse is currently under development in Howard County. A reclaimed wastewater system is currently being constructed to use effluent from the Little Patuxent WRP for cooling and wash down water to serve industrial customers along the Route 1 corridor. This is expected to be one of the first wastewater reuse facilities in Maryland, but final implementation awaits new State regulations. Additional opportunities for wastewater reuse are being explored. Reuse of flow from the Little Patuxent WRP helps meet the nutrient cap by reducing discharges from the plant.

A variation on wastewater reuse is to build a small treatment plant (or “scalping plant”) upstream of the Little Patuxent WRP, so flow is intercepted and treated for reuse before reaching the main plant. The County is considering options for scalping plants when potential customers are identified and site conditions are favorable.

Nutrient trading must take place within the framework of Phase I of Maryland’s nutrient trading policy, which addresses trading between point sources and trading involving the removal of septic systems. The policy divides the State into three large trading regions: the Potomac Tributary Basin, the Patuxent Tributary Basin, and the Eastern Shore and Western Shore Tributary Basin, including the Susquehanna River watershed. The Little Patuxent WRP is located within the Patuxent Tributary Basin, and the Patapsco WWTP is located within the Eastern Shore and Western Shore Tributary Basin. The policy states that sources within each basin may trade only with other sources within that basin. Nutrient trading will be implemented through the NPDES permit system. Point sources such as WWTPs must secure the right to nutrient credits for two 5-year permit terms and submit a plan to secure the credits for at least 10 years beyond this period.

Options for nutrient trading include:

- Acquire point source discharge credits from other dischargers.
- Upgrade treatment at an existing minor WWTP (a plant with a design capacity of less than 500,000 gpd).
- Retire an existing minor WWTP after connecting its flow to a Biological Nutrient Removal or ENR facility. The County is pursuing this option by connecting the MD-VA Milk Producers WWTP to the Little Patuxent WRP.
- Retire an existing septic system by connecting it to a WWTP with ENR.
- Land application of wastewater with pre-treatment and nutrient management controls.

What can each of us do to reduce wastewater flows and the nutrient content in these flows?

- ❖ Eliminate or reduce the use of garbage disposals.
- ❖ Compost food wastes (but not meat, dairy or fats) rather than use garbage disposal.
- ❖ Do not pour fats, oil or grease down the sink.
- ❖ Do not flush down the toilet or pour down the sink objects that should go in the trash or to a household hazardous waste collection site, such as tissues, pharmaceuticals, chemical cleaners, paints, solvents, etc.
- ❖ Install a composting toilet or waterless urinal.

- Implement nonpoint source practices. There is no State policy yet on this type of trading, Phase II of the nutrient trading policy will address trades between point and nonpoint sources.

Given the uncertainty surrounding future nutrient cap limits and the influence they have on future capacity at the Little Patuxent WRP and the Patuxent WWTP, the County should continue to look for opportunities to expand wastewater reuse and investigate options for nutrient trading to reduce nutrient discharges from the plants. In evaluating alternative options, consideration shall be given to the impact on County residents and the County with respect to, but not limited to, odor, transportation of sludge, capital costs, and operating costs.

Infrastructure Maintenance

Maintenance of the existing water and sewer system is an ongoing concern as portions of each system reach the design life of 50 years. The Bureau of Utilities schedules major infrastructure replacements, based on an equipment design life of 50 years. Major infrastructure replacements are funded through the capital budget process and are paid for by the Enterprise Fund. The Capital Improvement Master Program has a ten-year planning horizon, which facilitates planning for major infrastructure replacements. The Bureau of Utilities also evaluates infrastructure maintenance needs annually, based upon operations and maintenance activities. These activities can include the type, number and location of water main breaks and water quality inquiries, which may be related to aging water mains, and the type, number and location of sewer system overflows and facility operational efficiencies. Based on this evaluation, recommendations are given for replacement or renovation.



Source: Department of Public Works

The Department of Public Works, Bureau of Utilities, is responsible for maintaining the County's water and sewer system.

Policies and Actions

Policies and Actions to address drinking water supply and wastewater treatment are based on the following goals:

- Maintain a safe and adequate drinking water supply and adequate amounts of wastewater treatment capacity to serve projected growth.
- Invest in water and sewer infrastructure that will provide adequate treatment capacity and reduce pollutant loading in rivers and streams.
- Maintain the nutrient caps at the Little Patuxent Water Reclamation Plant and the Patapsco Wastewater Treatment Plant.
- Reduce nutrient loads from septic systems.
- Encourage individuals, communities, organizations and businesses to be partners in helping the County meet drinking water and wastewater treatment goals.

Policy 1: Ensure the safety and adequacy of the drinking water supply, and promote water conservation and reuse.

- 1.1 Increase funding and support for implementation of the Baltimore Reservoirs Action Strategy and the Patuxent Reservoirs Priority Resource Protection Program.
- 1.2 Require that properties added to the current Planned Service Area, large redevelopment sites within the PSA and large sites with zoning intensification within the PSA implement water conservation and reuse practices and technology.
- 1.3 Modify codes and regulations as needed to remove impediments for existing development, new development and redevelopment to implement water conservation and reuse practices and technology.
- 1.4 Allow and promote greywater reuse for nonpotable uses.
- 1.5 Conduct public outreach and education to encourage greater water conservation in homes, gardens and businesses.
- 1.6 Provide incentives to encourage property owners to install water conserving fixtures and appliances.



Source: WSSC

Maintaining a safe and adequate supply of drinking water is a goal of the Howard County Water Resources Element.

Policy 2: Ensure the adequacy of wastewater treatment capacity.

- 2.1 Accommodate flows from projected growth in the Planned Service Area by completing the expansion and upgrade of the Little Patuxent Water Reclamation Plant.
- 2.2 Require that properties added to the current Planned Service Area, large redevelopment sites within the PSA and large sites with zoning intensification within the PSA minimize increases in flow and the nutrient concentration in flow sent to the wastewater treatment plants.
- 2.3 Expand wastewater reuse and nutrient trading to reduce nutrient flows and help maintain the nutrient cap at the Little Patuxent WRP and the Patapsco WWTP.

Policy 3: Reduce nitrogen loads to surface and groundwater from septic systems.

- 3.1 Conduct public outreach and education to encourage use of State grant funds for septic system upgrades to nitrogen reducing systems when the funds are available on a Statewide basis.
- 3.2 Provide financial incentives to promote the use of nitrogen reducing treatment for new and upgraded septic systems.
- 3.3 Investigate options to establish and maintain a long-term septic system inspection and maintenance infrastructure for nitrogen reducing systems.

WATER AND RELATED LAND RESOURCES

Introduction

One purpose of the Water Resources Element is to ensure that the County has adequate land and water capacity for the treatment of stormwater runoff. To assess treatment capacity for stormwater runoff, the County must estimate current and future pollution loads from stormwater runoff, gauge the expected impacts of these loads on water quality in local streams, lakes and reservoirs, and determine the ability of existing and new tools to mitigate these impacts. Tools to mitigate impacts can include:

- Best management practices to reduce pollution from individual properties
- Development regulations
- Stormwater management, including new and retrofit facilities
- Stream and wetland restoration

These tools can be applied on a countywide basis or be tailored to specific watershed conditions under the guidance of watershed management plans.

Stormwater Management

Stormwater runoff is generated when the amount of rainfall or snowmelt on the land exceeds the land's capacity to absorb and hold water. Human activities can decrease the land's capacity to absorb water by removing vegetation, disturbing and compacting the soil, and by covering the land with impervious surfaces such as buildings, roads and parking lots. When the land's capacity to absorb and hold water is decreased, the water available for groundwater recharge is also decreased. In addition, the land generates more runoff, which flows at a faster rate into local streams.

These changes in groundwater recharge and runoff degrade water quality and habitat in local streams. Groundwater supplies the low flow or base flow in streams. As groundwater recharge decreases, groundwater levels drop, which subsequently lowers base flow levels in streams. If base flow levels drop too much, stream channels can dry up in times of low precipitation. Conversely, increased runoff flowing at a faster rate increases the frequency and magnitude of flooding and increases stream channel erosion. Increased channel erosion generates more sediment loading in the stream and undercuts banks, often toppling trees and other vegetation along the stream banks.



Increased stormwater runoff can increase stream channel erosion, degrading stream water quality and habitat.

Stormwater runoff also carries many pollutants from the land, including: oil, grease, salts and metals from roads and driveways; sediment, fertilizers, animal waste and pesticides from lawns and agricultural fields; and nutrients and metals deposited from air pollution. This type of pollution is called nonpoint source pollution, because it comes from many diffuse sources on the land. This pollution degrades water quality and habitat in our local streams and reservoirs and, subsequently, in the Chesapeake Bay.

Stormwater management has been required in Maryland since 1984 to mitigate some of the environmental impacts caused to water bodies by development. As more has been learned about the negative impacts stormwater runoff can have on water quality and habitat conditions in our local streams, Federal, State and local regulations for stormwater management have been expanded to increase pollutant removal, groundwater recharge and stream channel protection requirements.

The current State stormwater management regulations, adopted by Howard County in 2001, promote the use of low impact development or environmental site design (ESD). ESD emphasizes reducing the amount of stormwater runoff generated by using site design techniques that limit site disturbance and reduce the creation of impervious surfaces. The regulations promote the treatment of runoff by holding it on-site where it can be filtered and reabsorbed by the soil in multiple, small treatment facilities. This approach to stormwater management is different from the previous approach, which focused on collecting the majority of runoff in one or two large treatment facilities, most often stormwater management ponds.

ESD techniques can include: using cluster development and reducing road widths and parking requirements to limit site disturbance and impervious surfaces; preserving sensitive natural areas such as forests and nontidal wetlands; directing runoff from impervious surfaces such as rooftops to pervious surfaces such as lawns, to slow the flow of runoff and allow the runoff to filter through vegetation and soak back into the ground; and building smaller, on-site quality treatment facilities often called bioretention facilities. Bioretention facilities are small holding areas that treat runoff through natural processes, including soil filtration and nutrient uptake by vegetation. The use of ESD techniques can eliminate the need for large facilities such as ponds.

The State recently adopted new stormwater management regulations, in accordance with the Stormwater Management Act of 2007. The new regulations now require the use of ESD techniques to the maximum extent practicable and increase stormwater management requirements for redeveloping sites. The new regulations also require that local governments review and, where necessary, alter subdivision and zoning regulations to avoid impediments to ESD. The new State regulations went into effect on May 4, 2009 and the County has one year to adopt amended stormwater management regulations.



Environmental Site Design uses small treatment facilities, such as rain gardens (above), rather than large ponds (below).

Requiring stormwater management for redevelopment sites offers an important opportunity to improve water quality and quantity controls for stormwater runoff in areas that were developed prior to current stormwater management regulations. The County should ensure redevelopment is designed and implemented to reduce stormwater runoff and pollutant loadings to the maximum extent practicable. The County could also create incentives for new development and redevelopment to provide onsite or offsite water quality enhancements that exceed minimum regulatory requirements.

The National Pollutant Discharge Elimination System

As a requirement of the Federal Clean Water Act, Howard County has a National Pollutant Discharge Elimination System (NPDES) permit for discharges from the County's stormwater management system. The NPDES permit has significant requirements for maintaining and improving the County's stormwater management system.

Improvements to the stormwater management system may include retrofits of existing facilities to add water quality treatment and building new facilities to serve older areas built without stormwater management. The County is required to conduct watershed assessments and implement best management practices such as stormwater retrofits, stream channel restoration and stream buffer plantings to improve water quality in our local streams. The County must also document these water quality improvements and watershed restoration efforts through chemical, physical and biological monitoring.

NPDES permit requirements have placed and will continue to place substantial staff and financial demands on the County. These permit requirements are expected to increase as additional Federal and State requirements are incorporated into future permit conditions.

Stormwater Management Facilities

Stormwater management systems must be regularly inspected and maintained and, as they age, deteriorated systems must be upgraded or replaced. The County is required by both State and local legislation to conduct inspections of stormwater management facilities every three years. There are approximately 3,000 stormwater management facilities in the County, and approximately 800 of these facilities are maintained by the County.

In general, the County shares maintenance responsibilities with homeowners associations for residential facilities located on open space lots, while non-residential facilities are privately maintained. The County executes maintenance agreements with the owners of stormwater management facilities that specify maintenance responsibilities and the County's right to inspect the facilities. The County is responsible for enforcement of these maintenance agreements.

With increased environmental site design, small treatment facilities will continue to become more prevalent. These types of facilities can include downspout infiltration areas or drywells and bioretention



Source: Portland Oregon Bureau of Environmental Services

Small treatment facilities, such as this stormwater planter, will become more prevalent with Environmental Site Design.

facilities that can be located on private residential lots. Long-term inspection and maintenance of these facilities is an area of concern. Developments with ESD have significantly more facilities than developments with traditional management facilities such as ponds, increasing staff time for inspections. Inspections for these facilities could range from full inspection by County staff or a consultant, to self-inspection by the property owner with reporting to the County. Routine maintenance of ESD facilities located on individual residential lots becomes the responsibility of the individual homeowner, resulting in property owner education and maintenance enforcement issues. The County should evaluate alternatives for improving, enforcing and funding long-term inspection and maintenance of stormwater management facilities, particularly those facilities located on private residential lots.

Water Quality in Local Streams

Howard County lies within the Patuxent River and Patapsco River basins, two major tributaries to the Chesapeake Bay. Approximately 75% of the County is within the Patuxent River basin and the remaining 25% of the County is within the Patapsco River basin. The main stems of these rivers have many tributary streams which drain large areas of the County. The Patuxent River and Patapsco River basins in Howard County are divided by the State into seven major watersheds, as shown in Figure 7.

In accordance with the Federal Clean Water Act, Maryland has designated use classifications for all water bodies in the State, as listed in Figure 8. The use classifications for the streams in Howard County are shown in Figure 9 There are no Use II waters in Howard County.

Figure 8: Stream Use Classifications

Use Classification	Designated Use
Use I	Water contact recreation and protection of nontidal warm water aquatic life
Use II	Support of estuarine and marine aquatic life and shellfish harvesting
Use III	Nontidal cold water (Natural trout waters)
Use IV	Recreational trout waters

Note: A “-P” after a use classification number indicates an additional use for public water supply.



The County’s biological monitoring program measures the number and types of aquatic insects living in our streams.

Each use classification has specific water quality criteria. Baseline criteria are for Use I waters. The criteria are more stringent for certain parameters for Use II and IV waters, and Use III waters have the most stringent criteria.

In 2001, the County initiated a long-term, countywide biological monitoring program to track water quality and habitat trends in local streams. The results of this sampling indicate most streams in the County suffer from degraded water quality and habitat conditions. Stream corridor assessment surveys have also been conducted for all major watersheds. These surveys indicate eroding stream channels, a lack of riparian buffers and eroding pipe outfalls are common problems

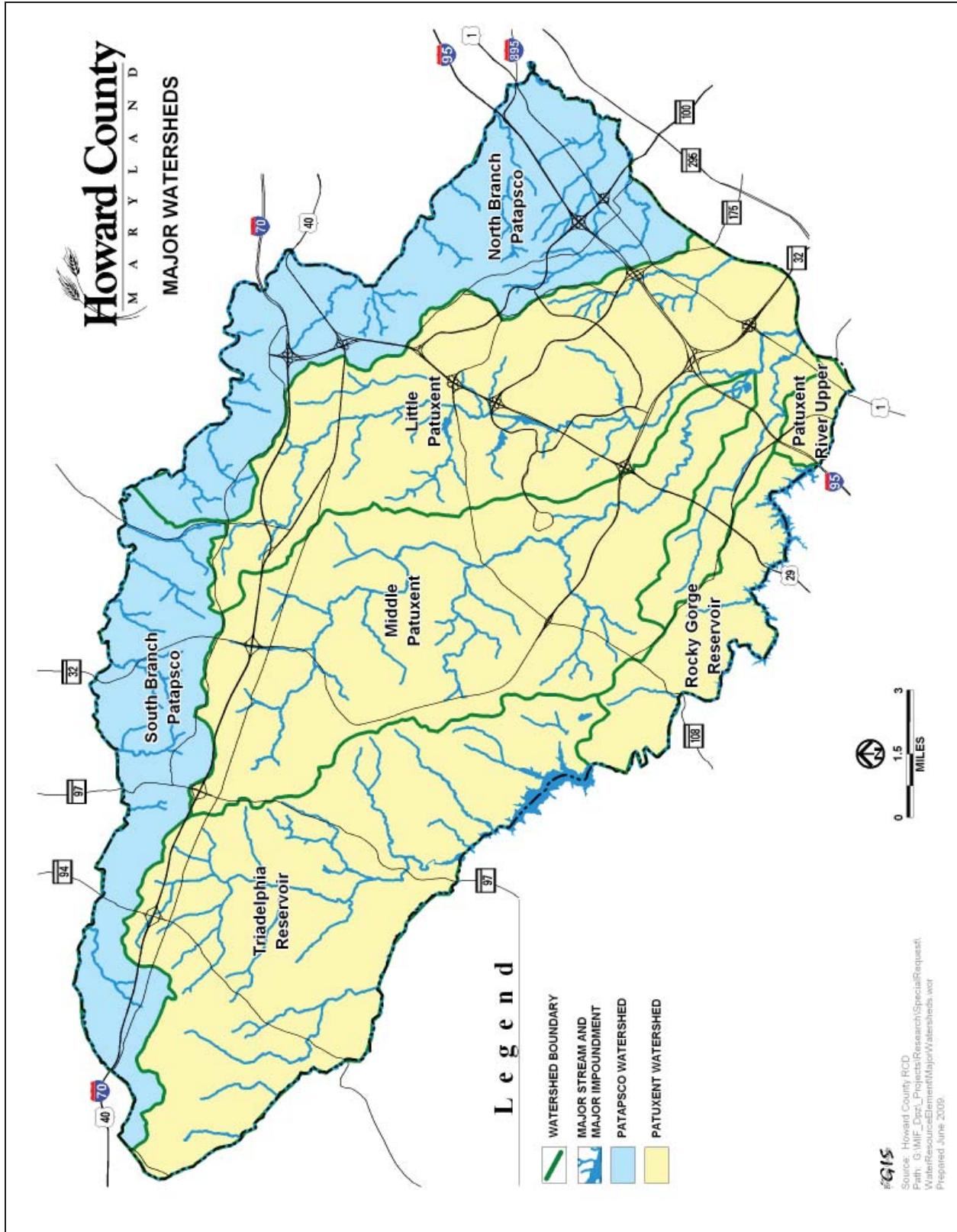

Figure 7: Major Watersheds

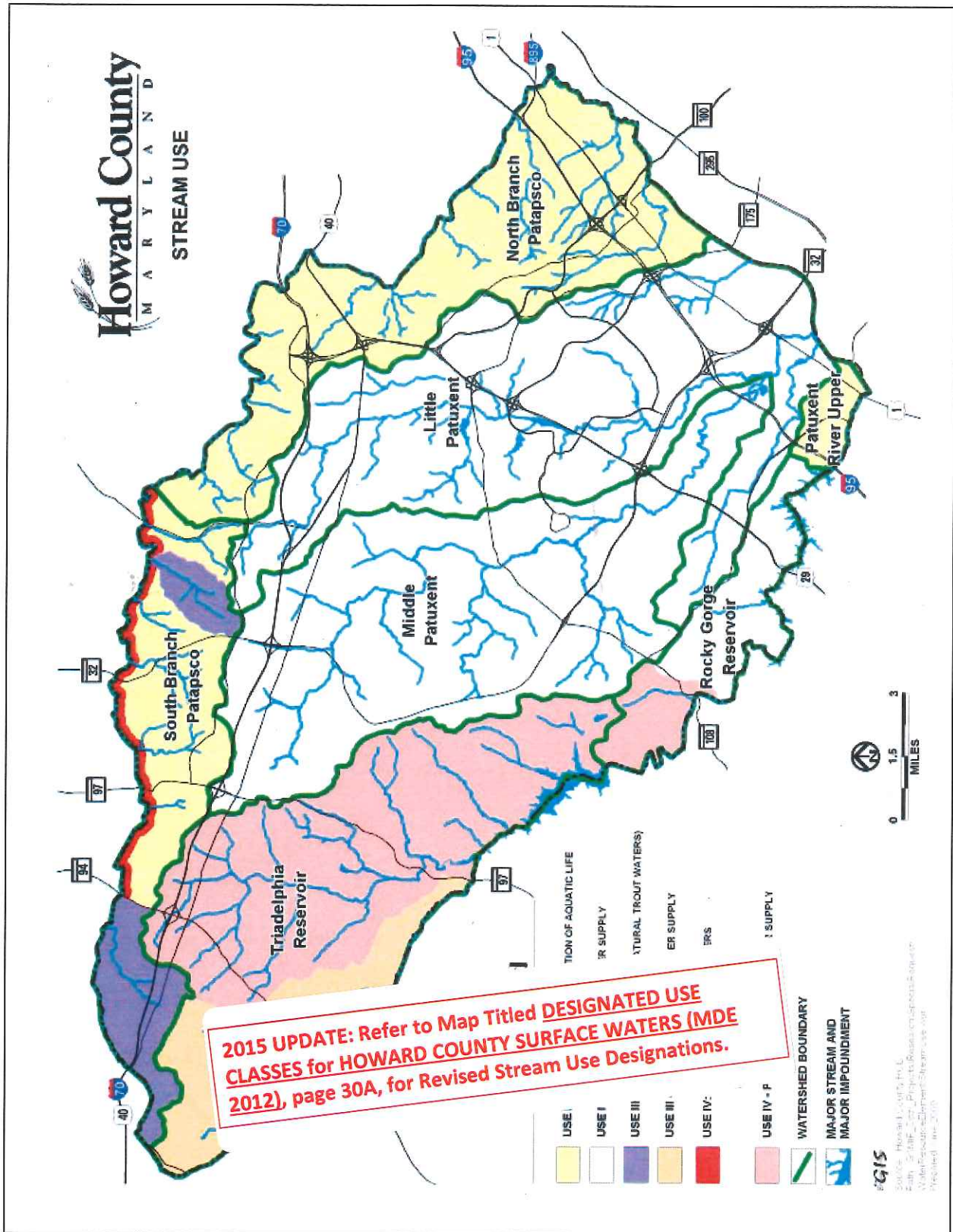
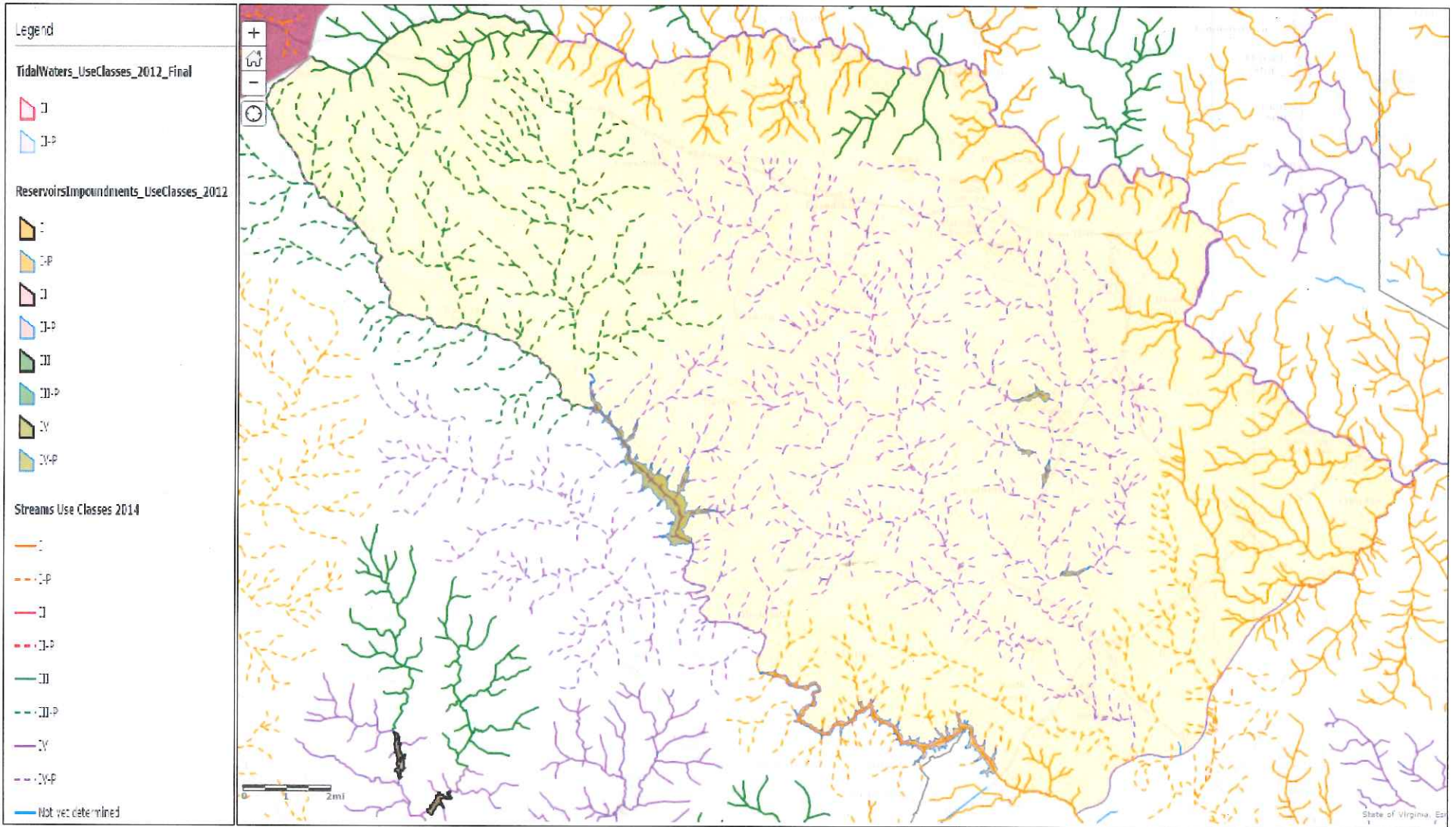

Figure 9: Stream Use



Designated Use Classes for Howard County Surface Waters (MDE 2012)

FIGURE 2-5
July 2015 Revision

in the watersheds. In addition, most water bodies do not meet State water quality standards for their use classification.

Tier II Waters

Despite the generally degraded condition of streams in Howard County, there are also stream segments in the County with excellent water quality and habitat for aquatic life. The State classifies these types of stream segments as Tier II waters and employs special procedures to regulate discharges to these waters to ensure water quality is not degraded. The State also encourages local governments to further protect these waters. There are six Tier II water segments in Howard County, all located outside the Planned Service Area, as shown in Figure 10. The State may designate additional Tier II waters as more information about stream conditions is collected.



A segment of the South Branch Patapsco River is designated as a Tier II water.

The County does not have information on potential water quality threats for these stream segments, which could include nearby development or agriculture that lacks best management practices or that impacts the stream buffer, particularly through forest clearing. The County should work with the State to collect information on these stream segments and institute any necessary measures to protect them.

Land Use and Nutrient Load Changes

Pollution that comes from many sources throughout a watershed is called nonpoint source pollution. By comparison, pollution that comes from a wastewater treatment plant or industrial plant discharge pipe is called point source pollution because there is a single source for the pollution.

To assess the County's future treatment capacity for stormwater runoff, the County conducted a nonpoint source (NPS) loading analysis to calculate the change in nutrient (nitrogen and phosphorus) loads due to proposed land use changes from 2007 to 2030. These land use changes were based on the Round 7a growth projections, as modified for additional growth in Downtown Columbia, the Village Centers and Doughoregan Manor. This analysis used a spreadsheet developed by the State as an analytical tool for preparing the Water Resources Element. This analysis incorporated runoff loads from land use change as well as groundwater loads from septic systems, and also estimated the future change in impervious cover.

Total land use change for the County in 2030 is projected to be approximately 21,351 acres. Total acreage for the County is approximately 162,177 acres, so this is a change for 13% of the County. This change occurs with an increase in low, medium and high density residential, and commercial land uses, with the majority of this increase being in low density residential land use. Low density residential land use is defined as ranging from 2 dwelling units per acre to 1 dwelling unit per 5 acres. This land use change has a corresponding decrease in other land uses, primarily cropland, forest, rural residential and pasture.

The projected change in land use for the County will result in a less than 1% increase in nitrogen loads and a 1% increase in phosphorus loads from the 2007 baseline load. The change in land use actually generates a decrease in runoff nitrogen loads, but this is offset by an increase in nitrogen loads from septic systems. Policies and Actions to reduce nitrogen loads from septic systems are discussed in the Drinking Water and Wastewater section.

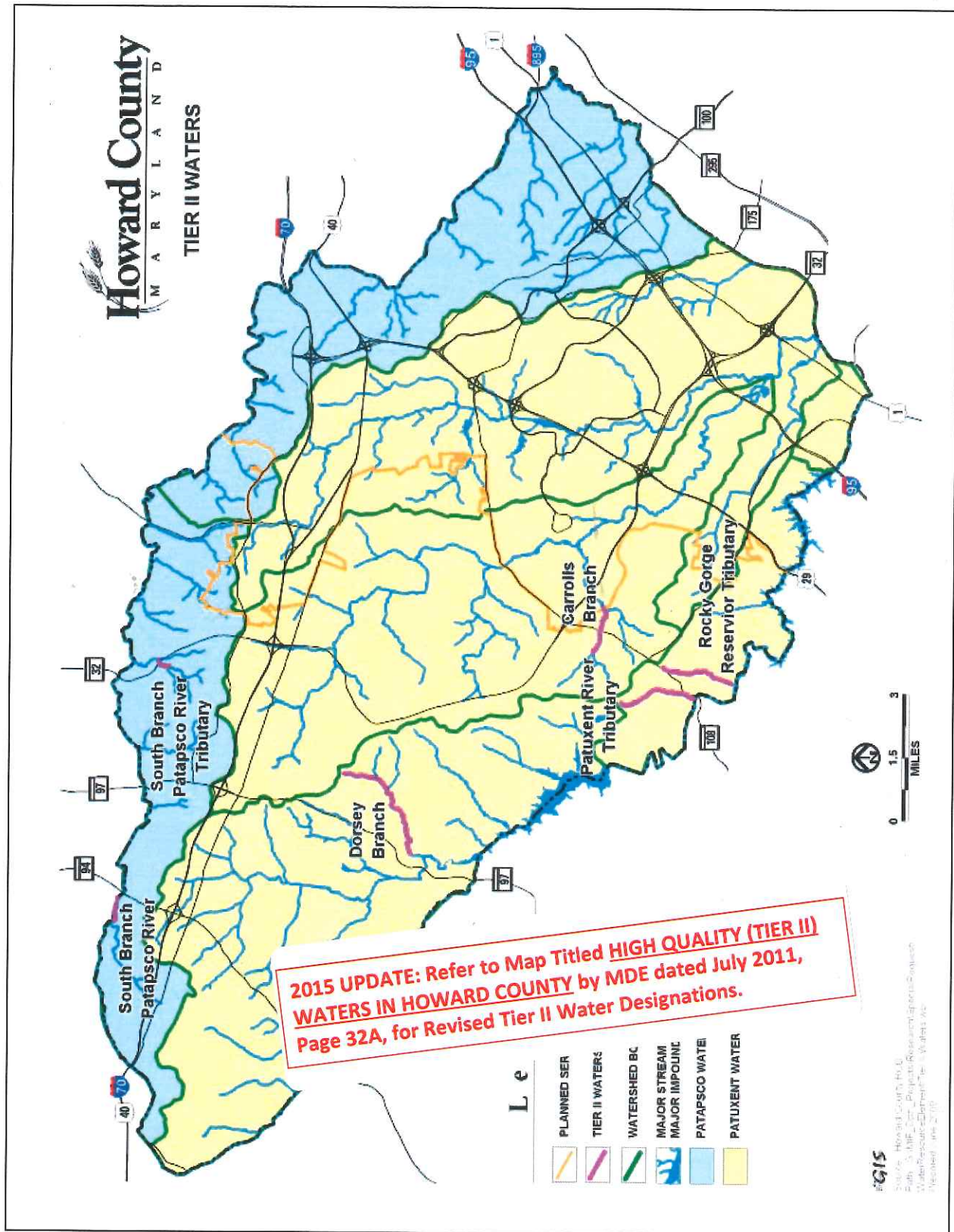
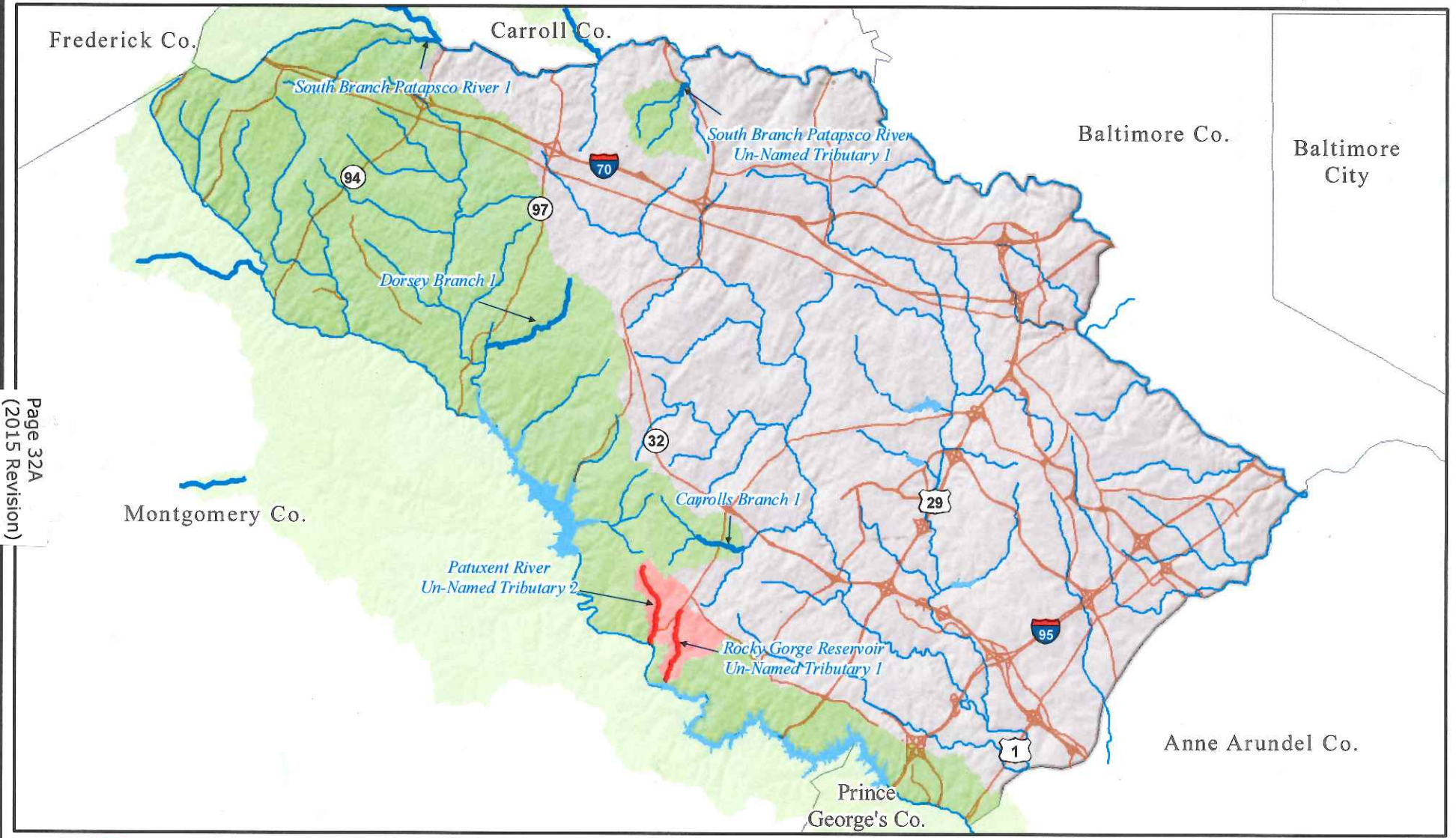

Figure 10: Tier II Waters

High Quality (Tier II) Waters in Howard County

[Code of MD Regulations 26.08.02.04-1]



Page 32A
(2015 Revision)



Martin O'Malley, Governor
 Anthony G. Brown, Lt. Governor
 Robert M. Summers, Secretary
 Kathy M. Kinsey, Deputy Secretary

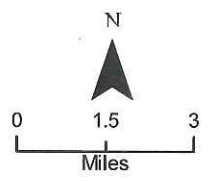

- Major Roads
- Streams/Rivers
- Howard County
- Municipal Boundary

- Tier II Waters**
- No Capacity
 - Capacity Available

- Tier II Watersheds**
- No Capacity
 - Capacity Available



Maryland Department of the Environment
 Science Services Administration
 Montgomery Park Business Center
 1800 Washington Boulevard
 Baltimore, Maryland 21230-1718
 Date Map Prepared: July 2011

The NPS loading analysis provided changes in land use and nonpoint source loads for the Patapsco and Patuxent River basins, and for each of the seven major watersheds in the County. When the total land use change is divided between these seven watersheds, almost 50% of this change occurs in the Middle Patuxent River (26%) and Triadelphia Reservoir (23%) watersheds. The Little Patuxent River watershed will see the third largest portion of the change at 17%, followed by the South and North Branches of the Patapsco, each at 13%. The Rocky Gorge Reservoir watershed will have a 7% portion of the change and the Patuxent River Upper watershed will have the smallest portion, at 1%.

Appendix B provides additional information on the NPS loading analysis and also provides a combined point and NPS loading analysis for the Patuxent and Patapsco River basins and the County. Total nitrogen and phosphorus loads in the County will decrease by approximately 13.8% and 12.4%, respectively, due primarily to the decrease in nutrient loads from the ENR upgrade to the Little Patuxent WRP and the Patapsco WWTP.

Impervious Cover

Impervious cover is a useful predictor of expected water quality and stream habitat conditions in a watershed. In general, as impervious cover increases with increasing development, stream health is expected to decline as forests are cleared, groundwater recharge is reduced, and polluted runoff into local streams increases in volume and frequency.

The County uses a system developed by the Center for Watershed Protection to place watersheds into one of three categories – sensitive, impacted or non-supporting – based on the level of impervious



Impervious cover in the County is projected to increase from 13% in 2007 to 15% in 2030.

cover. Sensitive watersheds have the lowest level of impervious cover and are expected to have the healthiest streams. Impacted watersheds have a moderate level of impervious cover and are expected to have streams showing clear signs of degradation. Non-supporting watersheds have the highest level of impervious cover and are expected to have streams with significant degradation. This system can be used to prioritize healthy watersheds for actions that will protect water quality and habitat, and to prioritize degraded watersheds for actions to restore water quality and habitat. The more degraded conditions are within a watershed, the more difficult and expensive restoration efforts become.

Overall, impervious cover in the County increases with the projected land use changes from 13% in 2007 to 15% in 2030, an increase of 2%. This increase in impervious cover will cause the Middle Patuxent River watershed to shift from the sensitive to the impacted category, and will cause the Little Patuxent River and Patuxent River Upper watersheds to shift from the impacted to the non-supporting category.

The impervious cover categories described above were developed when stormwater management requirements did not promote or require ESD. The new stormwater management regulations are intended to maintain and even improve predevelopment runoff conditions, which could significantly reduce the impacts from new impervious cover. The effectiveness of the new regulations in mitigating impacts from impervious cover should be monitored by the State and local governments.

Development Regulations to Protect Water Resources

County regulations adopted in December 1988 require undisturbed streamside buffer areas of 75 feet along perennial streams within residential zoning districts. In 1992, regulations were added to require undisturbed streamside buffers of 50 feet along intermittent streams in all zoning districts and along perennial streams in non-residential zoning districts. In 1988, Howard County also instituted wetland protection by requiring a 25-foot undisturbed buffer around nontidal wetlands. Additionally, most wetlands in the County are found within the 100-year floodplain, and the County has prohibited development within the 100-year floodplain since 1974.



A forested buffer provides the greatest benefits for stream water quality and habitat.

protection by requiring a 25-foot undisturbed buffer around nontidal wetlands. Additionally, most wetlands in the County are found within the 100-year floodplain, and the County has prohibited development within the 100-year floodplain since 1974.

In 2001, the stream buffer regulations were amended to require a 100-foot stream buffer in residential zoning districts for Use III and IV streams, located primarily in the Rural West. In addition, streams, wetlands and their buffers may no longer be located on residential lots, but must be located in open space or non-buildable preservation parcels, unless the residential lots are 10 acres or greater and the building envelope is set back from the buffer.

The effectiveness of stream and wetland buffers depends on the buffer width, vegetation and management practices. To provide the greatest benefit, buffers should be wide enough to allow adequate filtering of overland runoff and include adjacent steep slopes and highly erodible soils. A forested buffer provides the greatest benefits in terms of filtering pollutants, nutrient uptake through plant roots, erosion prevention, improved habitat for a variety of plant and animal species, and shading to keep water temperatures cool.

Current buffer requirements should be strengthened to enhance protection of streams, wetlands and floodplains. This could include increasing buffer width requirements for streams and wetlands, and instituting new requirements for floodplain buffers. In addition the stream buffer requirements should ensure that intermittent streams and perennial streams located in nonresidential areas have the same protections as streams located in residential areas.

Development regulations must be properly implemented and enforced to be effective. Sediment and erosion controls on construction sites must be correctly installed and maintained, stormwater management facilities must be built according to design plans, stream and wetland buffers and forest conservation easements must remain undisturbed during and after construction. The County should ensure there are adequate resources to monitor and enforce development regulations and to effectively educate developers and contractors.

Watershed Planning and Management

The health of our wetlands, streams, lakes and reservoirs is directly linked to the use of land within their watersheds. For this reason, a holistic approach to protecting, restoring and improving water resources should be based on a comprehensive assessment of land use, water quality and habitat conditions for the entire watershed.

The County takes a comprehensive, watershed-based approach to improve water quality and habitat in our local streams by conducting watershed studies to analyze conditions and design improvements. In general, watershed studies include a description of current water quality and habitat conditions in the watershed streams, an identification and severity ranking of problem areas, an identification and priority ranking of potential restoration projects, preliminary designs and cost estimates for priority restoration projects, and an implementation schedule.

Watershed Studies

In response to NPDES permit requirements, County watershed studies have focused on the more developed watersheds in the eastern portion of the County. The County has completed watershed studies for two major watersheds, the Little Patuxent River and North Branch Patapsco River watersheds. In addition, the major watersheds in the County were divided into 62 subwatersheds and prioritized for future detailed restoration studies. Subwatershed studies have been completed for: Wilde Lake and Centennial Lake within the Little Patuxent River watershed; Sucker Branch and Rockburn Branch within the North Branch Patapsco River watershed; and Cherry Creek within the Rocky Gorge Reservoir watershed. An additional watershed study for the upper Little Patuxent River addressing the five subwatersheds in the headwaters area was completed in 2009.

In addition to County efforts, the Columbia Association (CA) initiated a watershed study in 2008 for CA property, which lies within 20 subwatersheds. Phase I of the CA study focuses on six subwatersheds located in the center of the study area. The information collected by CA will be shared with the County and the County will work cooperatively with CA on restoration activities.

Watershed management plans are needed for each watershed in the County to set priorities and guide efforts to protect, restore and improve the County's water resources. To ensure watershed goals are being met, all watershed management plans should be revisited and updated as needed, on a regular cycle.

Watershed protection and restoration goals may vary by watershed. In a healthy watershed, the goal may be to protect and maintain current conditions, whereas in a degraded watershed, the goal may be to actively restore and improve current conditions. It is easier and more cost effective to protect high quality resources in a watershed than to restore degraded resources. The more degraded a watershed, the more difficult restoration becomes and in some more highly developed watersheds conditions may be so degraded that full restoration is prohibitively expensive.



The County has completed a subwatershed study for Wilde Lake. Phase I of the Columbia Association watershed study includes the Lake Kittamaqundi subwatershed.

Based on the NPS loading analysis, the Middle Patuxent River watershed is projected to have the largest percentage of County land use change and the largest area increase in impervious cover. If this land use change and resulting increase in impervious cover is not properly managed, significant water quality and

habitat degradation could occur. The Middle Patuxent River should be a priority for development of a watershed management plan to help guide future protection, mitigation and restoration efforts.

Currently, watershed studies are focused on stream water quality and habitat. Wetlands, another important water resource, are not mapped or assessed. State and Federal wetland maps exist for the County, but they are incomplete and outdated. Wetlands are mapped on individual properties as part of the development review process, but this information is not compiled into a countywide inventory. A wetland program that inventories and maps the County’s wetlands, and assesses opportunities to restore and protect existing wetlands and create new wetlands, would provide additional water quality and habitat benefits.

Restoration Projects

Restoration projects can include: building new stormwater management facilities and retrofitting existing facilities; planting forested buffers along streams; restoring and creating wetlands; stabilizing stream channels; and restoring instream habitats. Wherever possible, the County uses state of the art stream restoration design and construction techniques to achieve the long-term health of restored streams and their associated floodplains.

Source: Department of Public Works



Restoration projects can stabilize eroding stream channels and improve stream water quality and habitat.

Forest is the most beneficial land use for water quality, because forests absorb and filter stormwater runoff, prevent stream channel erosion, and provide shade to keep stream water temperatures cool. However, despite State and County forest conservation regulations, forest cover continues to be lost to development in Howard County as well as Statewide. As a result, Maryland is considering development of a “no net loss” of forest policy, but recommendations for this policy are not expected until the end of 2011.

The General Plan 2000 contains Policies and Actions related to the protection and restoration of forest, including development of a forest resource inventory and instituting a program to mitigate losses, targeting the establishment of forested stream buffers. Watershed management plans can be used to establish goals for forest cover and forested stream buffers in County watersheds. In more developed watersheds, it may be more appropriate to establish a tree canopy goal or a combination forest cover and tree canopy goal.

As each watershed and subwatershed restoration study has identified projects, these projects have been prioritized and added to the overall County watershed restoration master project list. This list also includes project sites identified from citizen referrals and complaints. The list is used as the basis for capital budget requests for restoration projects. The 2009 project list, which includes new projects from the Upper Little Patuxent Study, contains 150 projects with an estimated cost of \$40 million. The County’s current capital budget for these types of projects averages \$1.2 million annually, although this amount is not consistent from year to year. This level of funding allows about 5 projects to proceed each year. If the County wishes to do additional watershed studies and increase the pace of restoration, additional funding is needed.

Many of these restoration projects require cooperation and participation from private landowners, so public outreach and education is a critical component of implementation. These projects not only provide environmental benefits for our local water resources and the Chesapeake Bay, but they also help the County address regulatory requirements for stormwater management NPDES permit requirements and flooding issues.

Best Management Practices

In addition to major construction projects such as stream restoration and stormwater retrofits, watershed studies also identify best management practices (BMPs) to reduce nonpoint source pollution that could be implemented by private property owners. These BMPs can include: reducing the use of fertilizers, pesticides and herbicides; planting native shrubs and trees, especially along streams; redirecting downspouts so they drain to rain barrels and/or vegetated areas; and creating rain gardens, which are gardens planted in created depressions to capture and treat runoff through soil filtration and plant uptake.

The majority of land in the County is privately owned, so implementing BMPs on private property is critical to improving water quality and habitat, especially in areas that were developed before stormwater management and resource protection measures were in place. Public outreach and education are essential to raise awareness about the cumulative positive or negative impacts individual actions can have on the environment. However, the County budget for outreach and education to encourage and assist private property owners with the implementation of BMPs is a minor portion of the budget for the watershed management program. Current outreach and education efforts should be expanded and new programs initiated to increase BMP implementation on private property. Working with community and environmental organizations, business

associations and educational institutions often provides an effective way to reach a larger audience and encourage individual participation.

The County can also provide leadership in BMP implementation by incorporating environmentally sensitive site development and property management practices into County activities, as specified in the General Plan 2000 Policies and Actions. County actions can include: incorporating Green Building practices into facility design, construction and renovation; retrofitting stormwater management for County facilities; implementing demonstration projects to encourage their use by others; and reducing lawn and increasing forested riparian buffers and tree canopy on public property.

The watershed study recommendations for BMPs are directed primarily at residential and business property owners in the eastern portion of the County, but BMP implementation is also

What can each of us do to reduce stormwater runoff and water pollution?

- ❖ Plant trees.
- ❖ Replace lawn with native plants that need less water.
- ❖ Do not fertilize lawn and limit the use of pesticides and herbicides.
- ❖ Do not water lawn.
- ❖ Direct downspouts away from driveways to vegetated areas such as gardens and lawns.
- ❖ Install rain barrels.
- ❖ Create rain gardens.
- ❖ Install permeable pavement or pavers.
- ❖ Wash car at carwash or on lawn.
- ❖ Pick up pet waste and dispose of it in the trash.
- ❖ Do not litter.



Best management practices on private property can include the use of rain barrels to capture and reuse stormwater runoff.

Source: Rainwater Solutions at Hayneedle.com (permission pending)

Source: Soil Conservation District



Stream buffer plantings are an important best management practice for agricultural, residential and business properties.

important for residential and business property owners in the Rural West. It is also important in the Rural West that new best management practices continue to be implemented and existing practices be maintained on agricultural properties.

Best management practices for agricultural properties can include cover crops, conservation tillage, stream fencing to keep livestock out of streams, pasture management, stream buffer plantings and nutrient management. Nutrient management tailors the land application of fertilizers so the quantity applied does not exceed the needs of the crop. Implementing BMPs is generally voluntary, however, the 1998 State Water Quality Improvement Act requires the development and implementation of nutrient management plans for agricultural properties. Federal and State cost

share programs are available to help farmers implement these practices. The Patuxent Reservoirs Watershed Protection Program also has a local cost share fund for establishing stream buffers in the reservoirs watershed. The lead agency in the County for working with agricultural landowners to assist them with technical and financial planning for the implementation of best management practices is the Howard Soil Conservation District.

Regional Water Resources

In addition to watershed planning and management for our local water resources, it is also important to remember that the County is part of the larger Patuxent and Patapsco River basins. The Patuxent River basin is located within Howard, Montgomery, Anne Arundel, Prince George's, Calvert, Charles and St. Mary's Counties. Howard County contains 21% of the basin, the second highest of the seven counties in the basin. The Patapsco River basin is located within Carroll, Baltimore, Howard and Anne Arundel Counties, as well as Baltimore City.

In 1984, each of the seven counties in the Patuxent River basin formally adopted the Patuxent River Policy Plan, which contains land management recommendations to control nonpoint source pollution in the basin. The seven counties also each adopted a 1997 Policy Plan update, which addresses the continuing challenges of growth management, personal stewardship and financing. The County should continue to coordinate and cooperate with other local, regional and State agencies and organizations on joint watershed planning and management for the Patuxent and Patapsco Rivers.

The Patuxent and Patapsco Rivers are major tributaries to the Chesapeake Bay. The multistate effort to restore the Chesapeake Bay has been and continues to be a strong influence in promoting watershed-based planning and management efforts to protect not only the Bay, but also the Bay's numerous tributary rivers and streams.

The first Chesapeake Bay Agreement (the Agreement) was signed in 1983 by Maryland, Pennsylvania, Virginia, the District of Columbia and the Environmental Protection Agency (EPA). Initial Bay restoration efforts were predominantly focused on achieving a goal of the 1987 Amendments to the Agreement to reduce nitrogen and phosphorus loadings to the Bay by 40%, using 1985 as a baseline year. This reduction was to be achieved by 2000 and then held as a cap on subsequent loadings to the Bay.

In the 1992 Amendments to the Agreement, the 40% reduction goal was apportioned among each of the Bay's major tributary watersheds. In Maryland, nutrient reduction strategies were developed for each of the State's ten major tributary watersheds, including the Patapsco and Patuxent Rivers. These Tributary Strategies include diverse efforts such as improving treatment processes at wastewater treatment plants, installing agricultural best management practices, retrofitting stormwater management facilities and planting stream buffers.

In 1995, Maryland appointed a Tributary Team for each watershed to coordinate State and local efforts to implement the strategy. The Tributary Teams are made up of representatives of the business and agricultural communities, environmental organizations, State and local governments and agencies, and private citizens. Howard County participates in the Tributary Team for the Patapsco River and the Patuxent River Commission, which is the Tributary Team for the Patuxent River.

In 2000, Maryland recommitted to restoring the Chesapeake Bay by signing the Chesapeake 2000 Agreement. This Agreement was intended to achieve water quality goals for the Bay by 2010, and requires substantially greater nutrient and sediment load reductions to protect aquatic living resources in the Bay. Maryland revised the Tributary Strategies to reflect these new reduction goals.

The current Tributary Strategies focus on three sources for best management practice implementation:

- Urban point sources – this strategy focuses on wastewater treatment plant upgrades using Enhanced Nutrient Removal technology.
- Urban nonpoint sources – this strategy addresses stormwater runoff, septic systems, growth management and urban nutrient management.
- Agriculture – this strategy addresses best management practices on farmland.

Although compliance with the Tributary Strategies is considered voluntary, the urban point source strategy is incorporated into NPDES permits issued by the State for wastewater treatment plants, and the urban nonpoint source strategy is partially incorporated into NPDES permits for stormwater discharges.



The Patapsco River, which forms Howard County's northern boundary, is one of Maryland's ten major tributaries of the Chesapeake Bay.

Total Maximum Daily Loads

The Federal Clean Water Act requires that States identify water bodies that do not meet water quality standards. If necessary, the States must then develop a Total Maximum Daily Load (TMDL) or an allowable pollutant load and implementation plan to bring the water body into compliance with the water quality standards for that pollutant. Depending on the land uses within the watershed of that water body, the TMDL is divided or allocated between the point and nonpoint sources in the watershed. Stormwater management systems operating under an NPDES permit are included in the point source allocation. In general, the current point and nonpoint source loads in a watershed must be substantially reduced to achieve the TMDL.

The TMDL point source allocation must be included in the NPDES permit limits for regulated point sources. The TMDL allocations for nonpoint sources are addressed through the TMDL implementation

plan, which must provide reasonable assurance that future voluntary and regulatory actions will result in the needed nonpoint source reductions. There is no required time frame for achieving the TMDL.

Maryland has taken the approach that municipalities and counties that meet their stormwater NPDES permit conditions will be deemed to have controlled stormwater pollution to the maximum extent practicable and meet their load allocations under a TMDL. Recently, however, the State signaled that new NPDES stormwater permits may include a requirement to develop implementation plans to address the point source allocation for approved TMDLs. These implementation plans would be developed within one year of the new permit issuance and include best management practices, expected pollutant reductions, tracking processes, benchmarks, timelines and cost estimates. Howard County's NPDES stormwater permit will be up for renewal in 2010.

Howard County has the following approved TMDLs:

- Centennial Lake – for phosphorus and sediment
- Triadelphia Reservoir – for phosphorus and sediment
- Rocky Gorge Reservoir – for phosphorus

These TMDLs specify significant reductions (48 to 58%) in phosphorus loadings, with these reductions providing concurrent acceptable reductions in sediment loadings. These reductions must come primarily from controls on runoff from agricultural and developed land.



The TMDL for Centennial Lake specifies a 51% reduction in phosphorus loads to the lake.

An excessive input of the nutrients phosphorus and nitrogen to a water body can result in eutrophication, or the over-enrichment of the water body. The nutrients spur excessive growth of aquatic plants or algal blooms, which eventually die and decompose, using up dissolved oxygen. Excessive eutrophication can produce nuisance levels of algae and interfere with designated uses such as fishing and swimming. Excessive sediment loads can reduce the storage capacity and lifespan of lakes and reservoirs. The TMDLs for Centennial Lake, Triadelphia Reservoir and Rocky Gorge Reservoir are designed to limit eutrophication and ensure the lifespan of the lake and reservoirs.

Other waterbodies in Howard County listed by the State for potential future TMDLs, include the Little Patuxent River, the Middle Patuxent River, the Patuxent River Upper and the North Branch Patapsco River. Future TMDLs will also be developed for the larger Patapsco River and Patuxent River. In addition, the Bay States and the EPA recently acknowledged that voluntary efforts will not achieve the goals of the Chesapeake 2000 Agreement by 2010. Therefore, the EPA will develop a TMDL for nutrient and sediment loads for all sources within the Bay watershed. Early discussions by the Bay States and EPA indicate that the Tributary Strategies will be used as a baseline to develop actions needed to meet Maryland's share of the Bay TMDL.

One purpose of the Water Resources Element is to identify suitable waters and land areas to meet the stormwater management and wastewater treatment needs of existing and future development. All of the waterbodies in Howard County have or will require a TMDL at the major watershed and/or the basin scale. Those watersheds that are not listed by the State for a specific pollutant TMDL are listed for impacts to biological communities, which may in turn require a TMDL to control the identified stressor to these communities. The presence of a TMDL or the need for a future TMDL is an indicator that pollution control efforts must reduce loads to the water body from existing land uses and from future land use changes,

to prevent further degradation and restore the waterbody. This Water Resources Element includes recommendations for pollution control efforts for existing and future land uses to help meet TMDL goals. As TMDLs continue to be developed and nonpoint source pollution assessments are refined, the County can more closely document current and future pollution loads to measure achievement of the TMDLs.

Patuxent Reservoirs

The Rocky Gorge and Triadelphia Reservoirs supply water for the Washington region's public water systems. Howard County contains 53% of the watershed for these reservoirs and Montgomery County contains 46%. The remaining 1% of the watershed is divided between Frederick and Prince George's Counties. The Patuxent Reservoirs are the subject of a 1996 Patuxent Reservoirs Watershed Protection Agreement, signed by Howard, Montgomery and Prince George's Counties, the Washington Suburban Sanitary Commission (WSSC), the Howard and Montgomery County Soil Conservation Districts, and the Maryland-National Capital Park and Planning Commission. Signatory agencies agreed to work together to protect the long-term biological, physical and chemical integrity of the watershed.

The Patuxent Reservoirs Watershed Protection Program identified six priority resources for protection and restoration within the watershed. These resources are the reservoirs and drinking water supply, terrestrial habitat, stream systems, aquatic biota, rural character and landscape, and public awareness and stewardship. For each priority resource, the program identified the associated resource protection issue, corresponding measures, goals, and implementation items to address the issue, and the time line and responsible partners to accomplish the implementation items.

Implementation items include reservoir and stream monitoring, stream buffer planting, agricultural BMP implementation, stormwater retrofits, stream channel restoration, agricultural land preservation, and public outreach and education. A priority implementation item is planting forested stream buffers, because this provides multiple benefits for the priority resources. Many of these implementation activities are ongoing, but additional resources are needed to meet the implementation time lines.

The NPS loading analysis indicates that phosphorus loadings will decline by 3% in the Triadelphia Reservoir watershed, but will increase by 8% in the Rocky Gorge Reservoir watershed. Given the need for additional resources to meet current implementation objectives and the significant phosphorus reductions required to meet the TMDLs, increased funding and support should be given to the Patuxent Reservoirs Watershed Protection Program.



Source: WSSC

Increasing public awareness and stewardship of watershed resources is a priority of the Patuxent Reservoirs Watershed Protection Program.

Funding

The County's watershed management program helps the County comprehensively address: the design, construction and maintenance of an adequate stormwater management system; water quality and habitat improvements in our local streams; other NPDES permit requirements; and flooding concerns. However, the program requires a sustained source of funding, and if the County wishes to increase the pace of watershed restoration, including expanding outreach and education to increase the implementation of best management practices on private properties, additional funding is needed.



Funding is needed for stream restoration and stormwater management retrofits, to maintain the SWM system, and to ensure that the County meets its Federal water quality permit requirements.

Currently, watershed management is at a competitive disadvantage for General Funds when compared with other more widely recognized areas of public need such as schools and roads. The County should institute a dedicated fund to provide increased and sustained funding for the watershed management program, which is anticipated to continue to expand and evolve in response to Federal and State regulatory requirements.

Funding options for a dedicated fund should be equitable, enforceable and have reasonable administrative costs. All property owners are responsible for some degree of runoff, both from their individual properties and from public lands that serve the general public such as roads and schools. All property

owners would benefit from a comprehensive watershed management program to address stormwater management, water quality and habitat improvements in our local streams, and flooding. Therefore, an equitable fee that would apply to residential, business, agricultural and institutional property owners should be considered.

In addition to local funding, the County should continue to pursue Federal and State grant and cost-share opportunities. Grant and cost-share programs can provide funding for activities such as watershed planning, wetland creation, stream channel restoration, riparian forest buffer plantings, public outreach and education, and stormwater management.

Policies and Actions

Policies and Actions to address water and related land resources are based on the following goals:

- Use the best available water quality data and watershed analyses to guide growth policies to protect and improve water quality and meet water quality regulatory requirements.
- Improve stormwater management practices throughout the County to reduce nonpoint source pollutant loads and help achieve water quality standards.
- Protect and restore water resources, including streams, wetlands, floodplains and groundwater, to achieve water quality standards in the County’s rivers and streams.
- Engage the public in watershed conservation and promote a stewardship ethic.

Policy 4: Improve stormwater management practices throughout the County to help restore and protect water resources.

- 4.1** Amend County ordinances to implement the 2007 Storm Water Management Act.
- 4.2** Eliminate regulatory barriers to the implementation of environmental site design measures and create incentives to facilitate their use where appropriate.
- 4.3** Ensure redevelopment is designed and implemented to reduce stormwater runoff and pollutant loadings to the maximum extent practicable.
- 4.4** Create incentives for new development and redevelopment to provide onsite or offsite water quality enhancements that exceed minimum regulatory requirements.

- 4.5 Evaluate alternatives for improving, enforcing and funding long-term inspection and maintenance of stormwater management facilities, particularly those facilities located on private residential lots.

Policy 5: Ensure development regulations adequately protect water resources, including streams, floodplains and wetlands.

- 5.1 Work with the State to collect information on the Tier II stream segments in the County and institute any necessary measures to protect them.
- 5.2 Strengthen buffer requirements to enhance protection of stream, floodplain and wetland resources.
- 5.3 Ensure there are adequate resources to monitor and enforce development regulations and to effectively educate developers and contractors.

Policy 6: Use watershed management plans to guide the protection and restoration of water resources.

- 6.1 Prepare comprehensive watershed management plans for all watersheds, to set priorities and guide efforts to protect, restore and improve the County’s water resources. Complete and update all watershed management plans on a regular cycle.
- 6.2 Make the Middle Patuxent River watershed a priority for future study, protection and restoration.
- 6.3 Develop a wetland program to inventory, map, protect and enhance wetland resources.
- 6.4 Establish and achieve measurable goals for forest cover and riparian forest buffers in all County watersheds.
- 6.5 Encourage active participation of individuals, businesses and local community and environmental organizations in restoration activities.
- 6.6 Institute a dedicated fund (often referred to as a stormwater utility) to ensure increased and sustained funding for the watershed management program.
- 6.7 Pursue Federal and State grant and cost-share opportunities to secure additional resources for restoration efforts. Apply jointly with community and environmental organizations and with neighboring jurisdictions, as appropriate.



Protecting and restoring our rivers and streams is a goal of the Howard County Water Resources Element.

Policy 7: Coordinate regional protection of water resources.

- 7.1 Coordinate and cooperate with other local, regional and State agencies and organizations on joint watershed planning and management for the Patuxent and the Patapsco Rivers.

Policy 8: Safeguard the environmental integrity of the Patuxent Reservoirs.

- 8.1** Continue participation and leadership in interjurisdictional efforts to protect the Patuxent Reservoirs, including the Patuxent River Commission and the 1996 Patuxent Reservoirs Watershed Protection Agreement.
- 8.2** Increase funding and support for implementation of the Patuxent Reservoirs Priority Resource Protection Program.

Policy 9: Encourage individual environmental stewardship.

- 9.1** Conduct public outreach and education to encourage individuals and businesses both to be good stewards of their own property and to participate in community environmental enhancement efforts.
- 9.2** Initiate new and expand current outreach and education efforts to promote and assist private property owners with the implementation of best management practices, including installing rain gardens and rain barrels, planting stream buffers, replacing lawn with native plants, and increasing tree canopy.
- 9.3** Encourage the agricultural community to continue to work with local, State and Federal agencies and programs to implement best management practices.



Individual and group efforts such as planting trees are essential to achieving the goals of the Water Resources Element.

APPENDIX A: GROWTH PROJECTIONS

Introduction

The Department of Planning and Zoning's (DPZ) Division of Research uses a geographic information system (GIS) land use projection system to track and project growth and development in the County. The projection system is maintained on a continuous basis as new plans are processed and move through the development pipeline. All steps of the development process are tracked and mapped, including plans in process, recently approved and recorded plans, issued building permits, and building completions. New housing potential for uncommitted land is estimated by zoning. Uncommitted land includes all undeveloped land that is not currently being developed or planned for development. At any given time, the total capacity for all housing in the County can be determined. If the zoning is changed or a conditional use petition is granted, then the capacity is re-calculated.

This dynamic projection system can project new housing for any geography. Current geographies used include transportation analysis zones, DPZ statistical areas, DPZ planning areas, school planning polygons, water pressure zones, sewer service areas, police beats and fire box areas.

Growth projections are based on General Plan 2000. The General Plan establishes growth control totals that are the allowed annual levels of new residential units by planning area. Using these General Plan control totals, the model projects future housing units in the following order: 1) issued permits, 2) recorded unbuilt lots, 3) approved site plans, 4) in-process site plans, 5) in-process subdivision plans, and 6) uncommitted land. Once these units are projected, population for each year can be estimated based on persons per unit and occupancy factors. For more information on DPZ's projection system, please refer to the Research Report on Issue 15: County GIS Land Use Projection System, located on the DPZ web site at: <http://www.co.ho.md.us/DPZ/dpzpublicationsreports.htm#research>.

Since General Plan 2000 is only a 20-year plan, the growth projections for the Water Resources Element extend beyond 2020 to the year 2030. The same general pace of growth is assumed between 2020 and 2030, although development slows as land becomes more scarce in the out years.

Growth projections for the Water Resources Element are based on a modified version of Round 7a of the cooperative regional forecast. Round 7a was completed in 2008. These forecast "rounds" are updated annually and are part of the Baltimore Metropolitan Council Cooperative Forecasting process used to plan for future transportation projects in the region. Howard County also uses these projections to plan for schools, roads, water and sewer, and public safety infrastructure and operations.

The Round 7a projections were modified to address three key General Plan and / or Zoning Regulation amendments that have been requested during development of the Water Resources Element. These modifications include additional population and commercial acreage for the redevelopment of Downtown Columbia and Village Centers, and for new development on a portion of Doughoregan Manor.

These projections were aggregated by water pressure zone and sewer service area for the Department of Public Works to use in their water and sewer analysis. The following discusses the Round 7a projections with these modifications in more detail.

Projections

Residential Projections

As indicated in the Introduction, residential growth projections for the Water Resources Element are based on a modified version of Round 7a. Round 7a was completed in early 2008, based on the latest construction and development information and zoning. Like all projection rounds, General Plan 2000 control totals and pace of growth by planning area were used to establish new development at 5-year intervals. For the Water Resources Element, Round 7a projections were modified based on the following assumptions:

1. **An additional 3,900 apartment units are assumed in Downtown.** Round 7a assumed 1,600 new units in Downtown Growth Properties' - 3,900 extra units phased at 780 per year. Note that the Water Resources Element only goes to 2020. General Plan 2000 changes. General Plan 2000 (minimum), so the 3,900 units are phased at 780 per year. Note that the Water Resources Element only goes to 2020.
2. **An additional 1,000 apartment units are assumed in the Columbia Village Centers.** This assumption is based on recent interest for Village Center redevelopment. It is assumed that the apartment units are built evenly over 5-year increments from 2010 to 2030.
3. **An additional 2,000 units are assumed in Doughoregan Manor.** It is assumed that 1,500 apartment units are built between 2010 and 2020, and another 500 units are built between 2020 and 2025. The water and sewer analysis assumes that the Planned Service Area is expanded for this option.

2015 UPDATE: REFER TO CHAPTER 2 OF THE HOWARD COUNTY MASTER PLAN FOR WATER & SEWERAGE- 2015 AMENDMENT FOR UPDATED ROUND 8A PROJECTIONS.

Figure A-1 summarizes the housing unit projections based on the above assumptions.

There were close to 103,600 housing units in the County in 2007. This grows to about 139,100 housing units by 2030, an increase of 35,500 homes over the 23-year projection period used for the Water Resources Element. This is a 34.2% increase over the 2007 base.

Figure A-2 shows the growth per increment. The first increment is only for 3 years. For the 5-year increments thereafter, the rate of change decreases over time – that is, the number of new homes built during each 5 years is less than the previous 5-year period.

Figures A-3 through A-5 show the projected growth by unit type in the County – single family detached (SFD), single family attached (SFA), and apartment (APT). There is a relatively small number of mobile homes (MH) not shown in the figures, so totals in these figures will not match those shown in Figures A-1 and A-2. Overall, apartments (rental and condominium) represent the largest percentage of new units projected at 47% of the total. SFD homes account for 32% of total new units projected. Townhomes or SFA units account for the remaining 20% of future units.

Figure A-1: Housing Unit Projections from 2007 to 2030

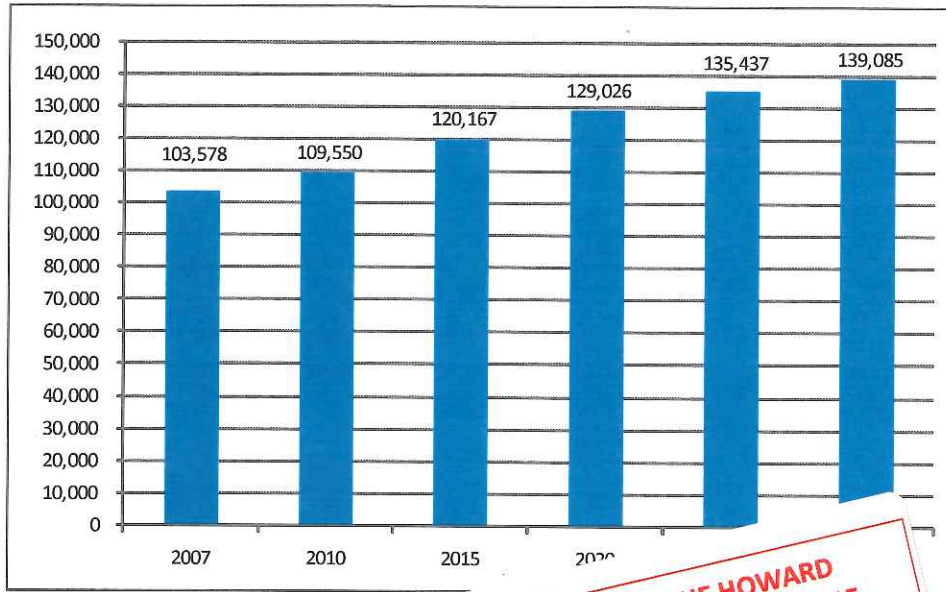

Figure A-2:

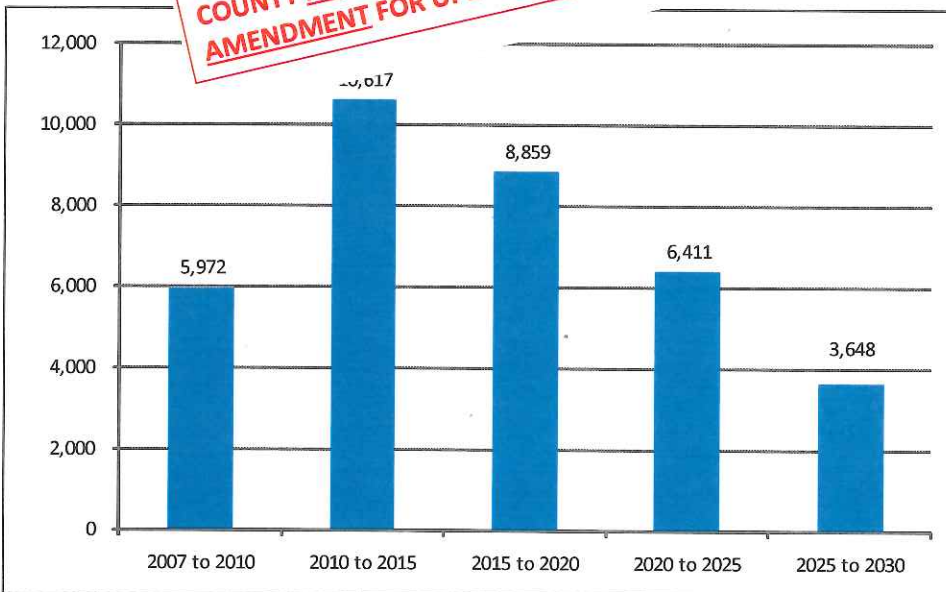

Figure A-3: Housing Unit Projections from 2007 to 2030

Unit Type	2007		2030		Growth	
	Amount	Percent	Amount	Percent	Amount	Percent
Single Family Detached (SFD)	56,479	55%	67,876	49%	11,397	32%
Single Family Attached (SFA)	21,645	21%	28,880	21%	7,235	20%
Apartment (APT)	23,918	23%	40,715	30%	16,797	47%
Total	102,042	100%	137,471	100%	35,429	100%

Figure A-4: Housing Unit Projections by Housing Unit Type from 2007 to 2030

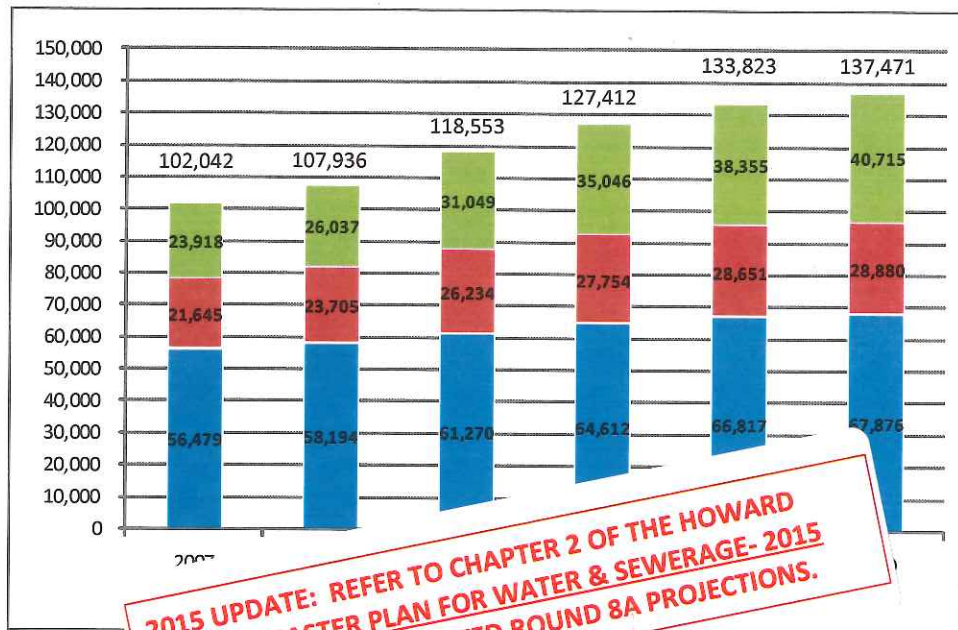
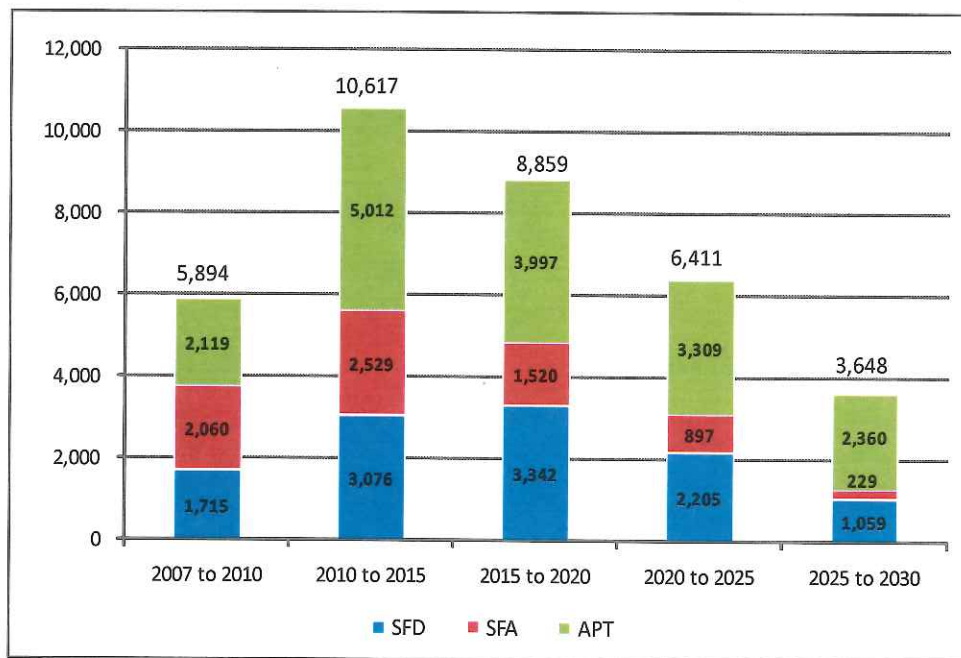

Figure A-5: Incremental Housing Unit Projections by Housing Unit Type from 2007 to 2030



APPENDIX A: GROWTH PROJECTIONS

Figure A-6 summarizes the current and projected household population growth. In 2007, the household population was 276,263. It is expected to grow to almost 330,000 by 2030, an increase of about 53,600 residents. This is a 19% increase over the 23-year projection period. These estimates are based on the household size and occupancy factors shown in Figure A-7.

Figure A-6: Household Population Projections from 2007 to 2030

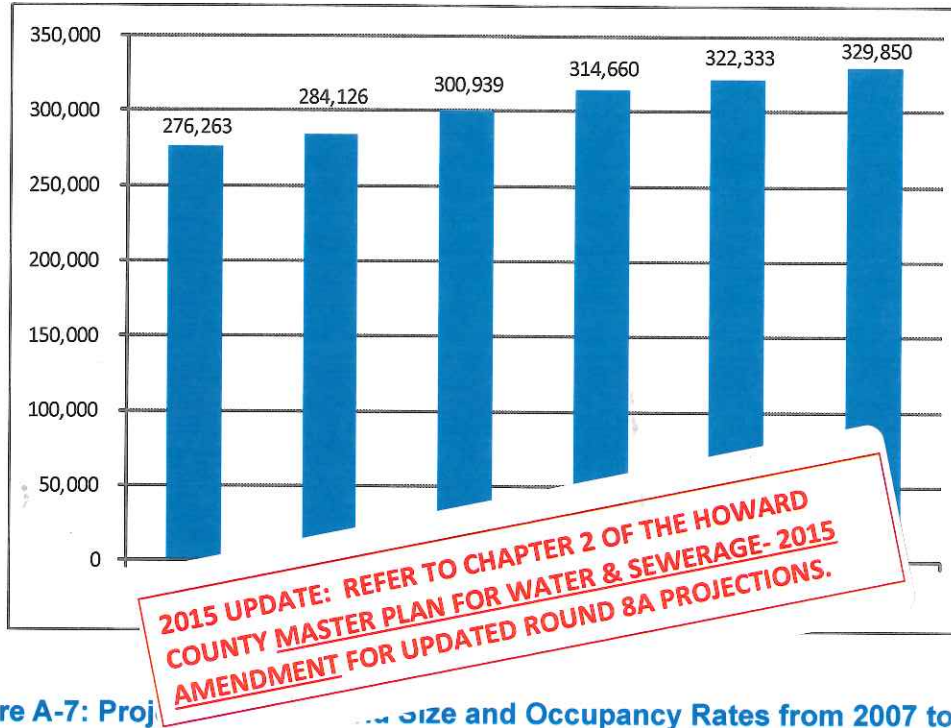

Figure A-7: Projected Household Size and Occupancy Rates from 2007 to 2030

HOUSEHOLD SIZE							
Unit Type	2007	2010	2015	2020	2025	2030	2035
SFD	3.11	3.11	3.05	2.98	2.92	2.92	2.92
SFA	2.59	2.59	2.53	2.48	2.43	2.43	2.43
APT	1.89	1.89	1.85	1.81	1.78	1.78	1.78
MH	2.50	2.50	2.45	2.40	2.35	2.35	2.35
Age-Restricted Housing	1.20	1.20	1.20	1.20	1.20	1.20	1.20

OCCUPANCY RATES	
Unit Type	Percent
SFD	98.0%
SFA	97.0%
APT	96.0%
MH	97.0%

Details by Water Pressure Zone and Sewer Service Areas

Figure A-8 summarizes the total housing unit growth from 2007 to 2030 for inside and outside the Planned Service Area (PSA). This information was forwarded to the Department of Public Works (DPW) to be used in their water and sewer analysis. The details include the distinction between age-restricted housing and regular housing. Age-restricted housing has a lower household size. The detailed breakdown at 5-year growth increments and by water pressure zone and sewer service area were provided to DPW and are available from DPZ upon request.

Figure A-8: Housing Unit Projections from 2007 to 2030

	SFD	SFA	APT	MH	SFD Age Restricted	APT Age Restricted	TOTAL
Outside PSA	3,961	5	0	(1)	58	0	6,013
Inside PSA	7,119	10,377	19,139	(113)	322	1,267	29,494
TOTAL							35,507

2015 UPDATE: REFER TO CHAPTER 2 OF THE HOWARD COUNTY MASTER PLAN FOR WATER & SEWERAGE- 2015 AMENDMENT FOR UPDATED ROUND 8A PROJECTIONS.

Figure A-9 shows the household population growth from 2007 to 2030. The population was determined by multiplying cumulative housing units times the household occupancy rates given in Figure A-7. The projected decline in household population in mobile homes is caused by the combination of a small increase in the number of mobile homes and the decrease in the household size. Similar to the housing unit information, detailed population projections at 5-year increments and by water pressure zone and sewer service area were provided to DPW and are available from DPZ upon request.

Figure A-9: Household Population Projections from 2007 to 2030

	SFD	SFA	APT	MH	SFD Age Restricted	SFA Age Restricted	APT Age Restricted	TOTAL
Outside PSA	8,389	5	0	(1)	58	0	2,304	10,755
Inside PSA	9,898	10,377	19,139	(113)	322	1,267	1,943	42,833
TOTAL	18,287	10,381	19,139	(114)	380	1,265	4,247	53,586

Nonresidential Projections

For the water and sewer modeling effort conducted by the Department of Public Works, future commercial and industrial acreage projections are required. For the Water Resources Element, the nonresidential acreage projections used are from the Round 7a projections, which were modified based on the following assumptions:

1. There will be redevelopment or an intensification of commercial use in Downtown Columbia totaling 1,008,040 square feet of retail space and 4,922,560 square feet of office space. There will also be an additional 640 hotel rooms during the development timeframe. All of this will be built out evenly over time between 2010 and 2035.

2. There will be redevelopment or an intensification of commercial uses in the Columbia Villages totaling 200,000 square feet of office space and 120,000 square feet of retail space. This will be built out evenly over time between 2010 and 2030.
3. For Doughoregan Manor, in addition to the 2,000 independent living units, there will also be a number of assisted living and nursing home beds in an institutional setting as part of a continuing care retirement community.

The cumulative industrial and commercial acreage totals for inside and outside the PSA are given in Figure A-10. Detailed projection information by sewer service area and water pressure zone was forwarded to DPW and is available from DPZ upon request.

Figure A-10: Cumulative Nonresidential Acreage from 2005 to 2030

Year	Outside PSA		Inside PSA		TOTAL	
	Indus	Comm	Indus	Comm	Indus	Comm
2005	160	346	3,610	3,179	3,770	3,525
2010	161	364	3,910	3,476	4,071	3,840
2015	161	368	4,149	3,692	4,310	4,060
2020	161	414	4,416	3,891	4,577	4,304
2025	161	462	4,666	4,149	4,827	4,611
2030	161	469	4,997	4,252	5,157	4,721

Modifications to the Growth Projections

Subsequent to the preparation of the growth projections used in this document, a proposal to develop 2,000 apartment units at Doughoregan Manor was withdrawn by the applicant. In the fall of 2009, the property owners submitted a new request to develop about 325 single family detached units on a portion of the property. It is assumed that the 325 homes would be built between 2010 and 2020. Based on the persons per household factors used in this report, the revised Doughoregan Manor development proposal would only have around 40% of the original population estimate. This new proposal for single family detached homes, if approved, would have a lesser demand for water and sewer services than the original proposal for a continuing care retirement community with 2,000 age-restricted dwelling units.

APPENDIX B:

NONPOINT AND POINT SOURCE LOADINGS

Introduction

One purpose of the Water Resources Element is to ensure that the County has adequate land and water capacity to meet the stormwater management and wastewater treatment needs of existing and future development. To assess treatment capacity for stormwater runoff and wastewater, the County estimated the nutrient nonpoint source pollution loads from stormwater runoff and septic systems based on current and future land use, and gauged the expected impacts of these loads on water quality in local streams and reservoirs. In addition, the nutrient point source pollution loads from the two major wastewater treatment plants serving the County were estimated, and the total County point and nonpoint source nutrient loads were estimated. The following discusses the results of that nonpoint and point source nutrient load analysis.

Land Use and Nonpoint Source Analysis

To assess future treatment capacity for stormwater runoff, the County conducted a nonpoint source loading analysis using the nonpoint source loading (NPS) spreadsheet developed by the Maryland Department of the Environment (MDE). MDE developed the NPS spreadsheet as an analytical tool for preparing the Water Resources Element. The NPS spreadsheet uses a simple assessment to calculate the change in nutrient (nitrogen and phosphorus) loads due to proposed land use changes and allows for a comparison between alternative future land use changes.

The NPS spreadsheet is designed for use with the Maryland Department of Planning (MDP) Growth Simulation Model (GSM), which projects future land use. Current land use is defined as the MDP 2007 land use / land cover. The GSM projects future land use on a parcel basis using population, household and employment projections, along with other local land management factors such as clustering, designated growth areas and land preservation programs. Population, household and employment projections are based on small area forecasts for Transportation Analysis Zones (TAZ). MDP uses a default zoning yield of 75% of the allowable density, although this yield is halved for infill parcels. MDP works with local governments to customize yield and to direct where growth occurs based on local growth management policies.

To confirm that the GSM was using the proper growth assumptions for Howard County, MDP also conducted a separate development capacity analysis for comparison with the County's capacity analysis. This comparison used the Baltimore Metropolitan Council TAZ Round 7a forecast. The MDP analysis included an estimate by zoning district for new household capacity. The MDP analysis estimated an additional 30,299 households, while the County analysis estimated an additional 30,674 households, a

difference of only 375 households or about 1%. This difference was not considered significant for this analysis.

The NPS spreadsheet calculates changes in nutrient runoff loads from land use changes, using a nutrient loading rate that reflects full implementation of the Tributary Strategy Best Management Practices (BMP). The Tributary Strategy BMP loading rate reflects the full spectrum of BMP implementation for all developed and agricultural land uses needed to achieve water quality goals for the Chesapeake Bay. This degree of BMP implementation may not be realistic, but it is acceptable for use in the NPS spreadsheet, because the NPS spreadsheet uses the same loading rate for current and future land use conditions. This analysis is used only for comparing the changes in current and future nutrient loads.

The nutrient loading rate is from the Chesapeake Bay Program Watershed Model phase 4.3, and varies by land use category and by basin. The loading rate is applied across 25 different land uses, including rural, low, medium and high density residential, commercial, industrial, cropland, pasture, wetlands and forest.

In addition to addressing nutrient loads from runoff, the NPS spreadsheet also includes a nitrogen loading rate for standard septic systems. The effect of replacing standard septic systems with nitrogen reducing systems can be estimated by halving the standard septic system loading rate. The NPS spreadsheet also calculates changes in impervious cover, agriculture and forest.

The GSM and the NPS spreadsheet divide Howard County into two basins – the Patuxent above the Fall Line and the Western Shore (which includes the Patapsco River) above the Fall Line. A small portion of eastern Howard County is below the Fall Line in each basin, but due to the large-scale analysis being conducted by the State, this refinement was not available. MDP used the GSM to provide an analysis for the two large basins, then ran a second analysis for the seven major watersheds in the County.

The results of the GSM for the Round 7a forecast generated future land use acreage in 2030 that was entered into the NPS spreadsheet. Land use changes for Downtown Columbia and Doughoregan Manor were then added to the NPS spreadsheet by the County. Redevelopment of the Village Centers did not result in a land use category change. The NPS spreadsheet then provided changes in nonpoint source loads for the County, the Patuxent and Patapsco River basins, and for the seven major watersheds. The following presents the results of the analysis from the GSM and the NPS spreadsheet.

Land Use Change

Figure B-1 presents the change in County acreage from 2007 to 2030 for each land use category. Total land use change for the County in 2030 is projected to be approximately 21,351 acres. Total acreage for the County is approximately 162,177 acres, so this is a change for 13% of the County. This change occurs with an increase in low, medium and high density residential, and commercial land uses, with the majority of this increase (81%) being in low density residential land use. Low density residential land use ranges from 2 dwelling units per acre to 1 dwelling unit per 5 acres. This land use change has a corresponding decrease in other land uses, primarily cropland, forest, rural residential and pasture

Figure B-2 presents the change in County acreage from 2007 to 2030 for developed land, agriculture and forest. In total, the County is projected to gain 20,710 acres of developed land, for an increase of 32% over current developed land acreage. Developed land includes low, medium and high density residential, commercial, industrial, institutional and transportation. The developed land acreage does not equal total land use change, because acreage in the industrial and institutional categories declined. The County is projected to lose 9,890 acres or 28% of existing agricultural land and 6,599 acres or 16% of existing forest.

Figure B-1: County Land Use Change

Land Use Category	2007 (acres)	2030 (acres)	Change (acres)
Low Density Residential	29,315	46,631	17,316
Medium Density Residential	16,282	19,275	2,994
Commercial	3,882	4,734	852
High Density Residential	4,773	4,962	189
Transportation	2,364	2,364	0
Row & Garden Crops	58	58	0
Water	1,007	1,007	0
Wetlands	30	30	0
Beaches	0	0	0
Bare Exposed Rock	0	0	0
Extractive	38	22	-16
Feeding Operations	127	122	-5
Agricultural Buildings	256	226	-30
Industrial	5,306	5,207	-98
Orchards & Vineyards	344	221	-123
Bare Ground	588	444	-144
Evergreen Forest	919	633	-286
Institutional	3,137	2,596	-541
Open Urban Land	3,441	2,733	-708
Brush	3,050	2,251	-800
Mixed Forest	4,225	3,409	-815
Pasture	5,280	3,616	-1,664
Rural Residential	13,688	10,347	-3,341
Deciduous Forest	34,280	29,583	-4,697
Cropland	29,789	21,721	-8,067

Figure B-2: County Developed Land, Agriculture and Forest Land Use Change

Land Use Category	2007 (acres)	2030 (acres)	Change (acres)
Developed	65,059	85,769	20,710
Agriculture	35,854	25,964	-9,890
Forest	42,475	35,876	-6,599

WATER RESOURCES ELEMENT

Figure B-3 presents the change in land use from 2007 to 2030 for the Patuxent and Patapsco River basins. Total land use change for the Patuxent River basin is projected to be approximately 16,091 acres. This is a 13% change in land use for the basin as a whole, and 75% of the total County land use change. Total land use change for the Patapsco River basin is projected to be approximately 5,642 acres. This is a 14% change in land use for the basin as a whole, and 25% of the total County land use change. The land use changes in each basin are similar to overall County changes.

Figure B-3: Land Use Change by Basin

Land Use Category	Patuxent			Patapsco		
	2007 (acres)	2030 (acres)	Change (acres)	2007 (acres)	2030 (acres)	Change (acres)
Low Density Residential	22,947	35,701	12,754	6,367	10,929	4,562
Medium Density Residential	11,921	14,414	2,493	4,361	4,862	501
Commercial	2,954	3,594	640	928	1,141	213
High Density Residential	3,526	3,730	204	1,247	1,232	-15
Transportation	1,768	1,768	0	596	596	0
Row & Garden Crops	58	58	0	0	0	0
Water	1,004	1,004	0	3	3	0
Wetlands	24	24	0	6	6	0
Beaches	0	0	0	0	0	0
Bare Exposed Rock	0	0	0	0	0	0
Extractive	3	3	0	35	19	-16
Feeding Operations	122	122	0	5	0	-5
Agricultural Buildings	186	173	-13	70	54	-16
Industrial	3,844	3,379	-465	1,462	1,828	366
Orchards & Vineyards	298	189	-109	46	32	-14
Bare Ground	521	393	-128	67	51	-16
Evergreen Forest	745	502	-243	174	131	-43
Institutional	2,344	1,999	-345	793	597	-196
Open Urban Land	2,601	1,986	-615	840	747	-93
Brush	2,552	1,891	-661	499	360	-139
Mixed Forest	2,682	2,297	-385	1,543	1,112	-431
Pasture	4,154	2,707	-1,447	1,126	909	-217
Rural Residential	10,289	8,165	-2,124	3,400	2,182	-1,218
Deciduous Forest	23,502	20,201	-3,301	10,778	9,382	-1,396
Cropland	23,730	17,475	-6,255	6,059	4,247	-1,812
Total	121,775		16,091	40,405		5,642

Figure B-4 presents the land use change for the seven 8-digit watersheds in the County. When the total County land use change is divided between these watersheds, almost 50% of this change occurs in the Middle Patuxent River (25.9%) and Triadelphia Reservoir (22.9%) watersheds. The Little Patuxent River watershed will see the third largest portion of the change at 17.0%, followed by the South and North

Branches of the Patapsco at 13.0% and 12.9%, respectively. The Rocky Gorge Reservoir watershed will have a 7.2% portion of the change and the Patuxent River Upper watershed will have the smallest portion, at 1.0%.

The land use change in most watersheds is primarily an increase in low density residential development. Exceptions to this pattern occur in the Little Patuxent River, which has a larger increase in medium density residential development, and the Patuxent River Upper, which has larger increases in commercial, and high and medium density residential development.

There is a small difference (2%) in the sum of the basin and individual watershed land use changes and the overall County change in land use. This occurs because if land use change is measured as the sum of positive land use changes, a particular land use may increase in the County but still increase or decrease in a particular basin or individual watershed. For example, industrial land use decreases for the County as a whole, but increases in the Patapsco River basin.

Figure B-4: Land Use Change by Watershed

8-digit Watershed	Change in Land Use (acres)	Percent County Total
Middle Patuxent River	5,639	25.9%
Triadelphia Reservoir	4,987	22.9%
Little Patuxent River	3,688	17.0%
South Branch Patapsco	2,835	13.0%
North Branch Patapsco	2,809	12.9%
Rocky Gorge Reservoir	1,555	7.2%
Patuxent River Upper	223	1.0%
Total	21,736	99.9%

Impervious Cover

Impervious cover, caused by built structures such as parking lots, roads and buildings, is a useful predictor of expected water quality and stream habitat conditions in a watershed. In general, as impervious cover increases with increasing development, stream health is expected to decline as forests are cleared, groundwater recharge is reduced, and polluted runoff into local streams increases in volume and frequency.

The County uses a system developed by the Center for Watershed Protection to place watersheds into one of three categories based on impervious cover, as presented in Figure B-5. Sensitive watersheds have up to 10% impervious cover and are expected to have the healthiest streams. Impacted watersheds have more than 10 and less than or equal to 25% impervious cover and are expected to have streams showing clear signs of degradation. Non-supporting watersheds have greater than 25% impervious cover and are expected to have streams with significant degradation. This system can be used to prioritize healthy watersheds for actions that will protect water quality and habitat, and to prioritize degraded watersheds for actions to restore water quality and habitat. The more degraded conditions are within a watershed, the more difficult and expensive restoration efforts become.

Figure B-5: Watershed Impervious Cover Categories

Watershed Category	Percent Impervious Cover	Expected Water Quality and Stream Health
Sensitive	Less than or equal to 10	Good to excellent
Impacted	Greater than 10 and less than or equal to 25	Fair to good
Non-supporting	Greater than 25	Poor to fair

Figure B-6 presents the change in impervious cover for the seven major watersheds in the County. Overall, impervious cover in the County increases from 20,458 acres or 12.6% of the County to 23,964 acres or 14.8% of the County, an increase of 3,507 acres or 2.2%. Impervious cover in the Patuxent River basin increases from 15,335 acres or 12.6% of the basin to 17,847 acres or 14.7% of the basin. Impervious cover in the Patapsco River basin increases from 5,123 acres or 12.7% of the basin to 6,117 acres or 15.1% of the basin. When this change in impervious cover is divided between the 8-digit watersheds, the smallest increase in impervious area will occur in the Patuxent River Upper, but because this is also the smallest watershed, it will give the largest percentage change at 5%. This increase in impervious cover will move this watershed from the impacted to the non-supporting category. The remaining watersheds all have a change of just under or over 2%, with a range of 1.8 to 2.6%.

Triadelphia Reservoir, South Branch Patapsco and Rocky Gorge Reservoir will all remain in the sensitive watershed category, with impervious cover below 10%. The Middle Patuxent River watershed will move from the sensitive category to the impacted category. The Little Patuxent River and the Patuxent River Upper watersheds will also move from the impacted to the non-supporting category. The North Branch Patapsco will remain in the impacted category.

Figure B-6: Impervious Cover by Watershed

8-digit Watershed	Impervious Cover (acres)		Impervious Cover (percentage)		Percentage Change
	2007	2030	2007	2030	
Middle Patuxent River (37,074 acres)	3,380	4,227	9.1% Sensitive	11.4% Impacted	2.3%
Triadelphia Reservoir (36,958 acres)	1,480	2,148	4.0% Sensitive	5.8% Sensitive	1.8%
Little Patuxent River (38,005 acres)	9,512	10,215	25.0% Impacted	26.9% Non-supporting	1.9%
South Branch Patapsco (16,086 acres)	676	1,059	4.2% Sensitive	6.6% Sensitive	2.4%
North Branch Patapsco (24,319 acres)	4,447	5,058	18.3% Impacted	20.8% Impacted	2.5%
Rocky Gorge Reservoir (7,996 acres)	535	742	6.7% Sensitive	9.3% Sensitive	2.6%
Patuxent River Upper (1,738 acres)	428	515	24.6% Impacted	29.6% Non-supporting	5.0%
Total	20,458	23,964			

Nutrient Loads

Figure B-7 presents the change in nonpoint source nutrient loads from 2007 to 2030 by basin and for the County as a whole. The overall change in land use for the County will result in a small increase in nitrogen loading of 793 pounds, or a less than 1% increase from the 2007 load, and a small increase in phosphorus loading of 880 pounds, or a 1% increase from the 2007 load. The change in land use generates an increase in nitrogen and phosphorus loads from low, medium and high density residential and commercial land uses, because these land uses are projected to increase in acreage. A decrease in nutrient loads is generated by other land uses that are projected to decrease in acreage. The majority of the decrease (68% for nitrogen and 71% for phosphorus) occurs from the change in cropland, with the next largest decrease (14% for nitrogen and 18% for phosphorus) coming from the change in rural residential land use. The decrease in cropland has such a significant impact on the change in nutrient loads, because the nitrogen and phosphorus loading rates for cropland can be up to twice the loading rates for developed land.

The change in land use actually generates a decrease in runoff nitrogen loads, but this is offset by an increase in nitrogen loads from septic systems. The projected nitrogen load from septic systems will be 22% of the total Countywide nitrogen load in 2030.

Figure B-7: Nonpoint Source Nutrient Loads by Basin and Countywide

Source	Nitrogen Loads (lbs/yr)				Phosphorus Loads (lbs/yr)			
	2007	2030	Change	%	2007	2030	Change	%
Patuxent								
Land Use	902,654	885,769	-16,885					
Septic	210,647	226,069	15,422					
Total	1,113,301	1,111,838	-1,463	-0.1%	70,510	70,288	-222	-0.3%
Patapsco								
Land Use	212,152	212,505	352					
Septic	75,025	76,928	1,903					
Total	287,177	289,433	2,256	0.8%	17,308	18,410	1,102	6.4%
Countywide								
Point	1,114,806	1,098,274	-16,532					
Septic	285,672	302,997	17,325					
Total	1,400,479	1,401,271	793	0.1%	87,818	88,698	880	1.0%

Under the Tributary Strategy BMP loading rates, nitrogen loading rates are generally higher in the Patuxent than the Patapsco River basin, but the difference in phosphorus loading rates is variable. A larger portion of the Patuxent River basin lies outside the Planned Service Area, and this basin has approximately three times the number of septic systems than does the Patapsco River basin.

In the Patuxent River basin, nitrogen and phosphorus loads have a minor decrease of less than 1% from 2007 loads. As with the Countywide loads, the change in land use generates an increase in nitrogen and phosphorus loads from low, medium and high density residential and commercial land uses. A decrease in

nutrient loads is generated by other land uses that are projected to decrease in acreage. The majority of the decrease occurs from the change in cropland, with the next largest decrease coming from the change in rural residential land use. The change in land use results in a significant decrease in runoff nitrogen loads, but this is offset by an increase in nitrogen loads from septic systems.

In the Patapsco River basin, nitrogen loads have a minor increase of less than 1% and phosphorus loads increase by 6% from 2007 loads. In a slightly different pattern from the Countywide loads, the change in land use generates an increase in nitrogen and phosphorus loads from low and medium density residential, commercial and industrial land uses. A decrease in nutrient loads is generated by other land uses that are projected to decrease in acreage. The majority of the decrease occurs from the change in cropland, with the next largest decrease coming from the change in rural residential land use. Both the change in land use and the addition of septic systems contribute to an increase in nitrogen loads.

Figure B-8 presents the change in nonpoint source nutrient loads from 2007 to 2030 for each major watershed. The GSM analysis of land use change for the seven 8-digit watersheds in the County did not include an assessment of septic systems, so total change in nitrogen cannot be calculated. Total change in nitrogen loads for land use Countywide is 16,532 verses 16,880 for the watersheds, or a difference of 2.0%. This seems reasonable, given the 2% difference in land use change. Total change in phosphorus loads for land use Countywide is 880 verses 758 for the watersheds, or a difference of 14%. This larger percentage difference may occur because the loadings are relatively small, so the difference is proportionately larger.

Figure B-8: Nonpoint Source Nutrient Loads by Watershed

8-digit Watershed	Nitrogen Loads (lbs/yr)				Phosphorus Loads (lbs/yr)			
	2007	2030	Change	%	2007	2030	Change	%
Middle Patuxent	287,212	279,200	-8,011	-2.8%	22,692	22,437	-254	-1.1%
Triadelphia Reservoir	304,724	292,447	-12,277	-4.0%	23,792	23,136	-756	-3.2%
Little Patuxent	251,277	252,778	1,501	0.6%	19,533	19,902	368	1.9%
S Branch Patapsco	99,787	95,052	-4,736	-4.7%	7,661	8,014	352	4.6%
N Branch Patapsco	112,364	117,196	4,832	4.3%	9,646	10,382	736	7.6%
Rocky Gorge	49,225	50,962	1,736	3.5%	3,716	4,017	302	8.1%
Patuxent River Upper	10,286	10,361	75	0.7%	785	795	10	1.3%
Total			-16,880				758	

Note that nitrogen loads are for land use only and do not include nitrogen loads from septic systems.

Point and Nonpoint Source Loadings

Figure B-9 presents the combined point source loads from the Little Patuxent Water Reclamation Plant (WRP) and the Patapsco Wastewater Treatment Plant (WRP), and nonpoint source loads from land use and septic systems for the Patuxent and Patapsco River basins and Countywide. It should be noted that the point and nonpoint source loads are not comparable in terms of accuracy. The point source loads are based on actual and projected flows and nutrient concentrations. The nonpoint source loads are based on

an assumption for best management practice implementation that is not currently in place, so they are useful only for comparing changes in nonpoint source loads.

Total nitrogen and phosphorus loads in the Patuxent River basin will decrease by approximately 1.5% and 3.0%, respectively, due primarily to the decrease in nutrient loads from the Enhanced Nutrient Removal (ENR) treatment upgrade at the Little Patuxent WRP. Total nitrogen and phosphorus loads in the Patapsco River basin will decrease by approximately 40.8% and 34.0%, respectively, due to the decrease in nutrient loads from the ENR upgrade at the Patapsco WWTP. Total nitrogen and phosphorus loads in the County will decrease by approximately 13.8% and 12.4%, respectively, due primarily to the decrease in nutrient loads from the Little Patuxent WRP and the Patapsco WWTP.

Figure B-9: Total Nutrient Loads by Basin and Countywide

Source	Nitrogen Loads (lbs/yr)				Phosphorus Loads (lbs/yr)			
	2007	2030	Change	%	2007	2030	Change	%
Patuxent								
Point	301,701	282,508	-19,193	-6.4%	22,770	20,167	-2,603	-11.4%
Nonpoint	1,113,301	1,111,838	-1,463	-0.1%	70,510	70,288	-222	-0.3%
Total	1,415,002	1,394,346	-20,656	-1.5%	93,280	90,455	-2,825	-3.0%
Patapsco								
Point	390,972	111,779	-279,193	-71.4%	23,306	8,383	-14,923	-64.0%
Nonpoint	287,177	289,433	2,256	0.8%	17,308	18,410	1,102	6.4%
Total	678,149	401,212	-276,937	-40.8%	40,614	26,793	-13,821	-34.0%
Countywide								
Point	682,673	394,287	-275,966	-40.4%	46,076	28,550	-16,594	-36.0%
Nonpoint	1,400,479	1,401,271	793	0.1%	87,818	88,698	880	1.0%
Total	2,083,152	1,795,558	-287,594	-13.8%	133,894	117,248	-16,646	-12.4%

Modifications to the Nonpoint and Point Source Loadings

Subsequent to the preparation of the nonpoint and point source nutrient load analysis used in this document, the proposal to develop 2,000 apartment units at Doughoregan Manor was withdrawn by the applicant. In the fall of 2009, the property owners submitted a new request to develop about 325 single family detached units on the same portion of the property. It is assumed that the 325 homes would be built between 2010 and 2020. If approved, the revised Doughoregan Manor development proposal would change the future land use on the property from high density residential to low density residential. Total land use change in the County would stay the same, but the 2030 land use projections would have a minor increase in low density residential land use and a minor decrease in high density residential land use. There would be a minor decrease in future impervious cover and future nonpoint source nutrient loads, because low density residential land use has a lower impervious cover and lower nutrient loading rate than high density residential land use. Point source loads from the Little Patuxent WRP and the County’s total nutrient loads would also be slightly lower than projected.



County Executive

Ken Ulman

Department of Planning & Zoning Contributing Staff:

Marsha McLaughlin, Director

Jeffrey Bronow, Chief, Division of Research

Charles Dammers, Chief, Development Engineering Division

Elmina Hilsenrath, Chief, Resource Conservation Division

Susan Overstreet, Project Manager, Resource Conservation Division

Lindsay DeMarzo, Planner, Resource Conservation Division/Office of Environmental Sustainability

Carrie Grosch, GIS Planner, Research Division

Department of Public Works Contributing Staff:

James Irvin, Director

Steve Gerwin, Chief, Bureau of Utilities

Jeff Welty, Deputy Chief, Bureau of Utilities

Don Lieu, Chief, Utility Design Division

Howard Saltzman, Chief, Stormwater Management Division

Mark Richmond, Stormwater Management Division

Health Department Contributing Staff

Bert Nixon, Director, Bureau of Environmental Health

Mike Davis, Assistant Director, Bureau of Environmental Health

Environmental Sustainability Board — Advisory Committee

Joshua Feldmark, Executive Director

Jim Caldwell

Chein-Chi Chang

Cathy Hudson

Mark Southerland



For information or alternative formats contact:

DEPARTMENT OF PLANNING AND ZONING

3430 Courthouse Drive
Ellicott City, Maryland 21043
410-313-2350

www.howardcountymd.gov

EXHIBIT 11

Reclaimed Water Management (RWM) Plan

Reclaimed Water Management (RWM) Plan for the



Howard County Department of Public Works Bureau of Utilities

Water & Wastewater Facilities
Engineering Design Services (WWFEDS)
Task No. 019
Conceptual Reclaimed Water
System Master Plan

Howard County Purchase Order M-4863
Consultant Services Agreement CA 08-13
GMB Job No. 2007337.00L

June 30, 2014

TABLE OF CONTENTS

1.	GOAL / PURPOSE	3
2.	RECLAIMED WATER UTILITY SERVICE AREA.....	3
3.	EXISTING AND SCHEDULED RECLAIMED WATER SYSTEM GENERATION, DISTRIBUTION, AND STORAGE FACILITIES	4
4.	ANTICIPATED FUTURE RECLAIMED WATER SYSTEM GENERATION, DISTRIBUTION, AND STORAGE FACILITIES	5
5.	WATER BALANCE – EXISTING FLOWS	5
6.	POTENTIAL FUTURE FLOWS	6
7.	SERVICE AGREEMENTS	8
8.	RECLAIMED WATER USE MONITORING PROGRAM.....	9
9.	EDUCATION AND NOTIFICATION PROGRAM	10
9.1.	Educational Information.....	10
9.1.1.	County Website	10
9.1.2.	Reclaimed Water Informational Brochure	10
9.1.3.	Reclaimed Water Presentation.....	11
9.2.	Notification Information.....	11
9.2.1.	Notification Signage.....	11
9.2.2.	Employee Notification and Training.....	11
10.	CROSS-CONNECTION CONTROL AND BACKFLOW PREVENTION PROGRAM.....	12
11.	UPDATING RECLAIMED WATER MANAGEMENT PLAN	12

FIGURES

Figure 2.1:	Existing, 5-Year, 10-Year, and Comprehensive Priorities for Reclaimed Water System Development (Figure 7.1 from Conceptual Reclaimed Water System Master Plan, Draft October 25, 2012)
Figure 2.2:	Existing & Pending Reclaimed Water Customers
Figure 2.3:	Water Appropriation Permits (Figure 5.2 from Conceptual Reclaimed Water System Master Plan, Draft October 25, 2012)
Figure 3.1:	Reclaimed Water System Existing and Scheduled Components
Figure 6.1:	15 Highest Potable Water Users Calendar Year 2011 (Figure 5.4 from Conceptual Reclaimed Water System Master Plan, Draft October 25, 2012)

TABLES

Table 2.1:	Existing & Pending Reclaimed Water Customers
Table 2.2:	Existing Water Appropriation Permits within Metropolitan District
Table 2.3:	Existing Water Appropriation Permits outside Metropolitan District
Table 3.1:	Little Patuxent Water Reclamation Plant (LP WRP) Final Effluent Flow Rate
Table 3.2:	Reclaimed Water Distribution Mains
Table 3.3:	Reclaimed Water Pumping Stations
Table 3.4:	Reclaimed Water Storage Tanks
Table 5.1:	Reclaimed Water Balance
Table 5.2:	Reclaimed Water Anticipated Demand by Existing & Pending Customers
Table 5.3:	Reclaimed Water Demand by Reuse Category
Table 1:	Class of Reclaimed Water Suitable for Various Types of Water Reuses from the MDE Guidelines for Use of Reclaimed Water, Draft 6-11-2012

APPENDICES

Appendix A:	Reclaimed Water Utility Customer Agreement
Appendix B:	Reclaimed Water Information on County Website
Appendix C:	Reclaimed Water Informational Brochure
Appendix D:	Reclaimed Water Presentation (Sample)
Appendix E:	Reclaimed Water Warning Sign
Appendix F:	Reclaimed Water Utility Initial and Annual Inspection Checklist

1. GOAL / PURPOSE

The County intends to have a reclaimed water system that is a stand-alone utility on par with its water and sewer utilities. The Reclaimed Water Management (RWM) Plan is intended to supplement the Conceptual Reclaimed Water System Master Plan (Draft October 25, 2012) in order to fill in the details on the reclaimed water utility including the reclaimed water itself, its treatment, its distribution and storage, and its end users as well as operation and maintenance of the reclaimed water facilities that will comprise the system.

The development of a RWM Plan is a requirement identified in the Maryland Department of the Environment Draft Guidelines for Use of Reclaimed Water (6-11-2012 version).

2. RECLAIMED WATER UTILITY SERVICE AREA

Within Howard County, the Metropolitan District is the area designated to receive service by the water utility and sewer utility with no plans to serve areas outside of it. The County intends to limit the ultimate service area of the reclaimed water utility to the Metropolitan District as well. Therefore the ultimate service area is the Metropolitan District with the exception of providing bulk reclaimed water to Fort Meade in neighboring Anne Arundel County.

The County anticipates gradually expanding the service area starting with the current reclaimed water service area near the Little Patuxent Water Reclamation Plant (LP WRP) and extending it northward to serve the southern portion of the Metropolitan District and extending it further to the northern part in later years. Figure 2.1: Existing, 5-Year, 10-Year, and Comprehensive Priorities for Reclaimed Water System Development (Figure 7.1 from Conceptual Reclaimed Water System Master Plan, Draft October 25, 2012) shows the existing and anticipated future facilities in 5-year increments and the anticipated service areas. For planning purposes, the service areas currently anticipated match the pressure zones for the water utility. This is because the reclaimed water utility will also operate under pressure so it will be defined by elevation and topographical features.

Unlike the water and sewer utilities which are used almost universally within the Metropolitan District, it is anticipated that the reclaimed water utility will serve mostly large volume customers. In terms of number of accounts, the vast majority of water and sewer accounts are individual residential units. However considering the limitations on reclaimed water use, it is anticipated that there will be relatively few individual accounts. These accounts will likely be limited to customers with high non-potable water demands.

Figure 2.2: Existing & Pending Reclaimed Water Customers shows the location of each of the proposed reclaimed water utility customers as well as any currently considering connecting. Table 2.1: Existing & Pending Reclaimed Water Customers lists each customer and details of the agreement plus includes the reuse category for each corresponding to Table 1 – Class of Reclaimed Water Suitable for Various Types of Water Reuses from the MDE Guidelines for Use of Reclaimed Water, Draft 6-11-2012.

Figure 2.3: Water Appropriation Permits (Figure 5.2 from Conceptual Reclaimed Water System Master Plan, Draft October 25, 2012) shows the location of all active water appropriation permits in Howard County broken down by potable, irrigation, and commercial uses. The details for each are listed in Table 2.2: Existing Water Appropriation Permits within Metropolitan District and Table 2.3: Existing Water Appropriation Permits outside Metropolitan District. Reviewing those located within the Metropolitan District, there are 43 active water appropriation permits of which 27 are listed as for potable use. Referring to Table 2.2: Existing Water Appropriation Permits within Metropolitan District, there are several large volume users listed as potable which are either erroneous designations or use only a portion of their flow for potable purposes such as Chase Mining which has two permits totaling 400,000 gpd average daily flow rate and 4,798,000 gpd peak maximum month average daily flow rate.

Although Howard County will supply reclaimed water to Fort Meade in neighboring Anne Arundel County, Howard County does not consider it to be part of its reclaimed water utility service area. Fort Meade purchases bulk reclaimed water from Howard County and assumes the responsibility for its use and disposal.

3. EXISTING AND SCHEDULED RECLAIMED WATER SYSTEM GENERATION, DISTRIBUTION, AND STORAGE FACILITIES

The components that comprise a reclaimed water system consist of reclaimed water sources, reclaimed water distribution mains, reclaimed water pumping stations, and reclaimed water storage tanks. All reclaimed water facilities that currently exist or are in design or under construction are shown in Figure 3.1: Reclaimed Water System Existing and Scheduled Components.

The Little Patuxent Water Reclamation Plant (LP WRP) is the only reclaimed water source in Howard County with no other sources anticipated. The LP WRP currently has a wastewater treatment rated capacity of 29.0 million gallons per day (mgd) average daily flow rate although has a much lower average daily flow rate of approximately 17.9 mgd. Table 3.1: Little Patuxent Water Reclamation Plant (LP WRP) Final Effluent Flow Rate presents the monthly average daily flow rate at the LP WRP since 1999 which has varied over the years and also varies within the year. Table 3.1: Little Patuxent Water Reclamation Plant (LP WRP) Final Effluent Flow Rate also presents the data on a seasonal basis with the seasons defined as Winter (January – March), Spring (April – June), Summer (July – September), and Autumn (October – December). All of the effluent from the LP WRP is available for potential water reuse.

Table 3.2: Reclaimed Water Distribution Mains lists all reclaimed water distribution mains that currently exist, are under construction, or are being designed. The information includes length and size of reclaimed water piping but is limited to that owned and operated by Howard County so does not include information on reclaimed water distribution piping on the customer side.

Table 3.3: Reclaimed Water Pumping Stations lists all reclaimed water pumping stations that currently exist, are under construction, or are being designed. The information includes the peak capacity of the pumping stations.

Table 3.4: Reclaimed Water Storage Tanks lists all reclaimed water storage tanks that currently exist, are under construction, or are being designed. The information includes storage volume and is separated into two sections. The “In-System Storage” section of the table lists those storage tanks owned and operated by Howard County which are used to supply the distribution system and maintain pressure throughout the reclaimed water system. The “Out-of-System Storage” section of the table lists those storage tanks that are not owned and operated by Howard County. These “Out-of-System Storage” tanks provide storage for individual customers but cannot supply back into the County distribution system.

The Guilford Reclaimed Water Storage Tank formerly was part of the potable water system but was unnecessary with the construction of a new potable water tank nearby. The tank will be converted to function as part of the reclaimed water system.

The new reclaimed water distribution main, pumping station, and storage tank infrastructure that are currently under construction for the Fort Meade military base are all being constructed by Howard County but only part of the facilities will remain under Howard County ownership and operation. When completed, Howard County will retain ownership and operation of the new reclaimed water pumping station, diversion chamber, and distribution main piping up to the perimeter fencing for the base. All piping extending onto the base and the new storage tank located within the Fort Meade secure perimeter will be turned over to American Water Company.

Howard County maintains as-built drawings of all existing facilities which are retained in the Bureau of Utilities.

4. ANTICIPATED FUTURE RECLAIMED WATER SYSTEM GENERATION, DISTRIBUTION, AND STORAGE FACILITIES

There are no other reclaimed water sources anticipated by Howard County. Therefore all future reclaimed water system components are anticipated to be extensions from the existing reclaimed water system with additional reclaimed water distribution mains, reclaimed water pumping stations, and reclaimed water storage tanks all using reclaimed water from the LP WRP.

All reclaimed water system expansions are planned for the future at 0 – 5 year, 6 – 10 year, and greater than 10 year phases as shown in Figure 2.1: Existing, 5-Year, 10-Year, and Comprehensive Priorities for Reclaimed Water System Development (Figure 7.1 from Conceptual Reclaimed Water System Master Plan, Draft October 25, 2012).

Figure 2.1: Existing, 5-Year, 10-Year, and Comprehensive Priorities for Reclaimed Water System Development (Figure 7.1 from Conceptual Reclaimed Water System Master Plan, Draft October 25, 2012) shows all existing and planned components of the reclaimed water system in Howard County consisting of the reclaimed water source which is the Little Patuxent Water Reclamation Plant (LP WRP), distribution mains, pump stations, and storage tanks. Each component is presented in a color-code using yellow for existing facilities, purple for planned facilities (0 – 5 years), blue for near-term future facilities (6 – 10 years), and orange for long-term future facilities (greater than 10 years).

5. WATER BALANCE – EXISTING FLOWS

The Reclaimed Water Balance is the calculation of flows within the reclaimed water utility from generation through reuse and ultimate disposal. Table 5.1: Reclaimed Water Balance summarizes each component on an annual and seasonal basis with the seasons defined as Winter (January – March), Spring (April – June), Summer (July – September), and Autumn (October – December).

The only source of reclaimed water is the Little Patuxent Water Reclamation Plant (LP WRP). Table 3.1: Little Patuxent Water Reclamation Plant (LP WRP) Final Effluent Flow Rate lists the monthly average daily flow rate and the seasonal average daily flow rate from the LP WRP since 1999.

The Howard County sanitary sewer collection system includes the Route 108 Sewage Pumping Station which can divert flow from the LP WRP drainage area to the Patapsco Wastewater Treatment Plant drainage area. The County typically does not operate the Route 108 Sewage Pumping Station but it could reduce the flow to the LP WRP by up to 3.0 mgd during periods of operation which could in turn reduce the amount of reclaimed water available by the same amount.

The reclaimed water is used by various customers for different purposes. Table 5.2: Reclaimed Water Anticipated Demand by Existing & Pending Customers lists the flows used on a customer by customer basis. Table 5.3: Reclaimed Water Demand by Reuse Category lists the flows used based on the six categories identified in Table 1 – Class of Reclaimed Water Suitable for Various Types of Water Reuses from the MDE Guidelines for Use of Reclaimed Water, Draft 6-11-2012. All flows are presented on an annual and seasonal basis.

Once treated wastewater leaves the Little Patuxent Water Reclamation Plant (LP WRP), it is either discharged or diverted into the reclaimed water system. Treated wastewater that is not reclaimed for reuse is discharged to the Little Patuxent River via the LP WRP outfall (NPDES Permit Number MD0055174). Treated wastewater that is reclaimed for reuse is provided to the customers served by the reclaimed water utility which are listed in Table 2.1: Existing & Pending Reclaimed Water Customers and are located as shown on Figure 2.2: Existing & Pending Reclaimed Water Customers.

Once a customer receives the reclaimed water, there are three ultimate outcomes possible for the reclaimed water. Flow is either returned to the sanitary sewer, depleted in the reuse process, or discharged at a location other than the LP WRP outfall. Table 2.1: Existing & Pending Reclaimed Water Customers lists the ultimate disposal of the reclaimed water by each customer.

Reclaimed water that is returned to the sanitary sewer is simply added back into the influent to the LP WRP for treatment and potentially for additional reuse. One example is Dreyer's Grand Ice Cream, Inc. where reclaimed water would be used and returned to the sanitary sewer system.

Some reclaimed water flow can be lost through the process of its reuse such as through evaporation from cooling uses or consumption such as through irrigation. Again using Dreyer's Grand Ice Cream, Inc. as an example, Dreyer's would use reclaimed water for cooling purposes through which part of the flow is lost to evaporation.

In some instances, reclaimed water is disposed of at the site of use or in a product. For example, Laurel Sand and Gravel, Inc. would use reclaimed water for washing aggregates and in producing concrete.

Reclaimed water supplied to Fort Meade is a simple subtraction from the reclaimed water supply as Howard County supplies it to Fort Meade in bulk and Fort Meade takes on the responsibility of ensuring its proper use and ultimate disposal. Fort Meade uses the reclaimed water for cooling and discharges it to the sanitary sewer system on base which flows to the Fort Meade Wastewater Treatment Plant (NPDES Permit Number MD0021717)

Reclaimed water storage tanks are listed in Table 3.4: Reclaimed Water Storage Tanks but are not considered part of the reclaimed water balance calculations. Similar to storage tanks in potable water distribution systems, reclaimed water storage tanks provide additional volume to the reclaimed water distribution system in times of high demand and refill during times of low demand effectively leveling out the flow rate peaks and troughs over the course of the day. Once the initial fill-up is complete, the reclaimed storage tanks inflow and outflow should balance over the course of the day.

6. POTENTIAL FUTURE FLOWS

Looking to the future on the supply side, the potential reclaimed water supply will be equivalent to the anticipated future flow to the Little Patuxent Water Reclamation Plant (LP WRP). Referring to the Howard County Master Plan for Water and Sewerage, 2011 Amendment, the County anticipates future flows to the LP WRP to increase to 25.20 mgd average daily flow rate by Year 2035 (Table 9) thus increasing the amount of flow potentially available for reuse as reclaimed water.

On the demand side, estimating future reclaimed water demands is not practical for multiple reasons. The LP WRP is operated to achieve an effluent equivalent to Class IV reclaimed water quality which makes it acceptable for all approved reclaimed water reuses. Therefore any potential user of non-potable water is a potential customer. However connecting to the reclaimed water utility is voluntary so only customers who want the utility will be connected. Each potential customer will have to weigh the costs and benefits (economic and other) of connecting to decide if it is worth it. There will likely be some potential customers who would benefit from connecting to the reclaimed water system and others who would not.

The capital investment needed to construct the infrastructure for reclaimed water suggests that it would be economically feasible only for large volume water users who can use non-potable water for their purposes. Among businesses that already exist in the County, these would likely be users who currently use potable water from the County but could possibly also include users who obtain their water from wells. Potential customers would also have to be entities that are large enough to shoulder the burden of the additional cost of operating the reclaimed water system on-site and meeting the requirements of the reclaimed water agreement.

For potential customers, an indirect benefit provided by reclaimed water is greater water supply security. During periods of drought when water restrictions could be implemented (which potentially could affect both potable water users and well water users), reclaimed water users would not be affected by any restrictions thus providing a degree of water supply security.

Even though there is no way to predict future reclaimed water demands, there can be some value in identifying those known entities that have the potential for becoming future customers of the reclaimed water utility. That being the case, the most likely candidates for becoming reclaimed water customers are those who use large volumes of potable water and those with water appropriation permits.

Figure 6.1: 15 Highest Potable Water Users Calendar Year 2011 (Figure 5.4 from Conceptual Reclaimed Water System Master Plan, Draft October 25, 2012) shows the high volume water users within the Metropolitan District that are connected to the County's potable water system. Many of these users are food producers so are unlikely candidates for reclaimed water for use in processing although may be interested in reclaimed water for use in cooling.

Figure 2.3: Water Appropriation Permits (Figure 5.2 from Conceptual Reclaimed Water System Master Plan, Draft October 25, 2012) shows the location of all active water appropriation permits located in Howard County and identifies each as potable, irrigation, or commercial use. Table 2.2: Existing Water Appropriation Permits within Metropolitan District and Table 2.3: Existing Water Appropriation Permits outside Metropolitan District list the water appropriation permits and includes other pertinent information such as Average Daily Flow Rate and the Maximum Month Average Daily Flow Rate. The water appropriation permits located outside of the Metropolitan District are listed separately as the County has decided to provide the reclaimed water utility only within the Metropolitan District. However, the information is still maintained should there be an opportunity for the reclaimed water utility to serve these potential customers.

Another potential increase to reclaimed water demands could come from businesses looking to locate to the region. Howard County's location between the Baltimore market and Washington, D.C. market make it an attractive location for many businesses. For those that use large volumes of water that does not have to be potable, the cost savings and supply security provided by County's reclaimed water system could be an incentive to locate to Howard County.

Since the LP WRP discharges effluent meeting Class IV reclaimed water quality requirements, all MDE approved uses are eligible so there is great potential for adding users. However, the County does not have specific businesses / institutions identified that have expressed interest in receiving reclaimed water for reuse other than those listed in Table 5.2: Reclaimed Water Anticipated Demand by Existing & Pending Customers.

The reclaimed water system will serve customers located in both the drainage area to the LP WRP and the Howard County portion of the drainage area to the Patapsco Wastewater Treatment Plant. Even though the LP WRP which is the reclaimed water source receives sanitary sewage flow from only approximately 69% of the area within the Metropolitan District with the other 31% flowing to Baltimore County via the Patapsco Interceptor and on to the Patapsco Wastewater Treatment Plant owned and operated by the City of Baltimore, the reclaimed water system will serve the entire area within the Metropolitan District. In other words, reclaimed water from the LP WRP which is used in the Patapsco WWTP drainage area is anticipated to be discharged to the sanitary sewers there and ultimately will be treated at the Patapsco WWTP.

Many reclaimed water utilities across the country were initiated out of necessity due to strains on water supply (such as drought, diminishing groundwater table, and saltwater intrusion) or difficulty in disposing of wastewater treatment plant effluent. In Howard County, the impetus behind developing a reclaimed water utility was not out of necessity but rather looking to the future. The water supply for the County is adequate and anticipated to be so in the future. Effluent disposal is

also not a concern for the County as growth has not been limited due to lack of wastewater treatment capacity.

Referring to the six (6) reclaimed water reuse categories listed in Table 1 – Class of Reclaimed Water Suitable for Various Types of Water Reuses from Chapter 3 – Treatment Quality by Class Required for Uses of Reclaimed Water from the MDE Guidelines for Use of Reclaimed Water, Draft 6-11-2012, the County anticipates the following types of uses for reclaimed water:

- Irrigation for golf courses, ornamental nurseries, parks, playgrounds, schoolyards, cemeteries, lawns, and landscaping;
- Filling water bodies such as aesthetic fountains, ponds, and lagoons;
- Commercial reuse for toilet and urinal flushing, laundries, car washing, window washing, and pressure cleaning;
- Industrial use for dust control and soil compaction, washing aggregates and making concrete, parts washing and cleaning, equipment operations, and other manufacturing processes;
- Cooling water for towers, air conditioning, and closed loop cooling.

Alternately, the County anticipates little or no demand for the other MDE approved uses for reclaimed water such as:

- Irrigation for food crops, non-food crops, forested land, turf, pasture, sod farms, silviculture (forest / woodlands), and highway landscapings and other green open spaces;
- Fire protection.

The ultimate reclaimed water service area corresponds to the Metropolitan District which is comprised of primarily residential areas but with some significant commercial and industrial development as well. Therefore, there is currently little agricultural activity within the Metropolitan District so reclaimed water for farming purposes is not anticipated.

Use of reclaimed water for fire protection would require a greater degree of redundancy in the reclaimed water distribution and storage system and larger sized pipes in order to convey the higher flow rates. In addition it could raise concerns about pooled water after a fire. Therefore reclaimed water for fire protection purposes is not anticipated.

To summarize, there is no way to estimate future reclaimed water demands with any degree of probability considering the number of unknown factors that are outside of the County's control. However, there is no possibility of demand outstripping supply for the foreseeable future as the current reclaimed water supply of 17.9 mgd greatly exceeds demand possible of current potential reclaimed water users (6.42 mgd) even if the 15 highest potable water users (1.799 mgd), the water appropriation permit holders within the Metropolitan District (1.315 mgd), and the water appropriation permit holders outside of the Metropolitan District (1.463 mgd) were all also connected.

7. SERVICE AGREEMENTS

In order to ensure that both the reclaimed water customer and provider have their specific obligations and responsibilities identified, each reclaimed water customer is required to enter into a legal agreement with Howard County.

Appendix A: Reclaimed Water Utility Customer Agreement is a standard agreement that the County has adopted as the starting point for any reclaimed water customer. If there are provisions listed in the standard agreement that the potential reclaimed water customer does not agree with, the County will consider modification at the County's discretion.

8. RECLAIMED WATER USE MONITORING PROGRAM

As part of the Customer Agreement, each reclaimed customer agrees to submit to periodic checks by the County to ensure compliance with the agreement and with the requirements of the Maryland Department of the Environment Guidelines for Use of Reclaimed Water.

Prior to activating the connection to the County's reclaimed water distribution system, the customer must provide as-built drawings of all reclaimed water facilities on-site for review by the County and accompany County personnel during an inspection. Upon County approval, the connection will be activated and the customer provided with reclaimed water.

Once the reclaimed water connection is active, the County may conduct inspections as frequently as desired. However, the County expects to perform inspections on an annual basis unless there are instances of non-compliance or other concerns that would prompt more frequent inspections.

The inspections are intended to encompass all reclaimed water facilities on-site with the intent of ensuring that all necessary measures are in place in order to prevent potential human contact with reclaimed water. The inspections will focus on, but not be limited to, ensuring the following items:

- Notification information and measures are in place to inform all personnel (employees, visitors, residents, etc.) entering the area of use that reclaimed water is in use;
- All reclaimed water equipment and facilities are in functional condition and in operational order;
- All reclaimed water equipment and facilities are secured and properly marked;
- All personnel with access to the reclaimed water equipment and facilities are properly trained to work with reclaimed water;
- All reclaimed water is under control including runoff and spray;
- There is an effective cross-connection control and backflow prevention program in place and it is being followed.

The water quality of the reclaimed water is monitored at the point at which it leaves the LP WRP and the flow rate is recorded at the reclaimed water meter for each individual customer.

The County will monitor and report chlorine residual readings and turbidity readings in the reclaimed water in accordance with the current discharge permit for the Little Patuxent Water Reclamation Plant (NPDES Discharge Permit Number: MD0055174, State Discharge Permit Number: 13-DP-1421).

As the reclaimed water system expands, the County will monitor and report chlorine residual readings and turbidity readings in the reclaimed water at each County-owned reclaimed water pumping station and provide re-chlorination infrastructure.

Each Customer will have an individual Memorandum of Understanding (MOU) Agreement or User Agreement specifying any additional chlorine residual or turbidity monitoring requirements.

9. EDUCATION AND NOTIFICATION PROGRAM

In order to make information available to the public on reclaimed water, the County has developed a number of sources intended to provide as much information as is sought by the public. The information is intended to be general in nature but does include links if more specific and detailed information is desired. Much of the same information is presented in each case just using a different medium.

9.1. Educational Information

9.1.1. County Website

In order to provide information to the public on reclaimed water, there is a section of the County website dedicated to the reclaimed water utility at <http://www.co.ho.md.us/reclaimedwater>. In addition to the general description and information on the reclaimed water utility, the website has links to the following information:

- *Reclaimed Water Utility Customer Agreement* – If a prospective customer is interested in obtaining reclaimed water service, he can see the standard agreement (Appendix A: Reclaimed Water Utility Customer Agreement) which lists the information required in order to receive reclaimed water service and the obligations that the customer assumes upon entering the agreement as well as the Application for Receiving Reclaimed Water Service. Viewing this standard agreement is also useful for the general public in order to get a sense of what requirements each reclaimed water utility customer is held to.
- *Howard County Master Plan for Water and Sewerage* – With the inclusion of a new chapter dedicated to the reclaimed water utility being added to the Master Plan covering the existing and planned reclaimed water utility facilities, prospective customers and the general public can see the anticipated future of the reclaimed water utility in Howard County.
- *Maryland Department of the Environment* – The Howard County reclaimed water utility is being developed in accordance with the Maryland Department of the Environment Guidelines for Use of Reclaimed Water.
- *Environmental Protection Agency* – The EPA has extensive general and historical information on the use of reclaimed water throughout the United States and abroad.

For anyone interested in obtaining more detailed information specific to Howard County, the website also includes the contact information (address, telephone number, and e-mail address) of the Reclaimed Water Program Manager.

Refer to Appendix B: Reclaimed Water Information on County Website which contains the text of the webpage.

9.1.2. Reclaimed Water Informational Brochure

The County offers a multitude of informational brochures for its citizens covering many topics. These brochures are available at most County offices and various other outlets throughout the County.

The reclaimed water informational brochure provides a general overview of the County's reclaimed water utility. The brochure is laid out to include a section dedicated for mailing with the return address in place and with areas for placing an address for mailing to an individual and a stamp so that it could be mailed to anyone requesting information from the County on the reclaimed water utility.

Refer to Appendix C: Reclaimed Water Informational Brochure for a copy of the brochure.

9.1.3. Reclaimed Water Presentation

The County has prepared a standard slide presentation on reclaimed water which is included in Appendix D: Reclaimed Water Presentation (Sample). This brief slide presentation provides a general overview of reclaimed water, much of it the same as the other informational sources developed by the County. However it is intended to be flexible and can be modified for a specific audience or event.

For example if the presentation is intended for a public meeting or meeting with stakeholders, the presentation is broader in order to provide a complete picture of the program. However if the presentation is part of a training session for County personnel, the presentation can be modified to include more technical information related to the specific tasks of each position. In each case, the presentation can be modified based on the audience and the time allotted. Presentations at public meetings or other specific events will take place on an as-needed basis depending on requests to the Reclaimed Water Supervisor.

In addition to live presentations, the standard slide presentation will also be accessible via the County's website.

9.2. Notification Information

9.2.1. Notification Signage

Under Section 11: Operational Requirements of Appendix A: Reclaimed Water Utility Customer Agreement, each reclaimed water customer is required to provide signage at each entrance to his site at each point of use stating that reclaimed water is in use. This signage is intended to ensure that all personnel on site whether residents, employees, visitors, etc. are aware that reclaimed water is in use and that human contact is not permitted.

In accordance with MDE Guidelines, all signage is required to be a minimum of 8 inches wide by 4 inches high, be predominantly purple in color, and contain text stating "Reclaimed Water, Do Not Drink". In addition to the requirements identified in the MDE Guidelines, the County also requires that these signs include the County website address and the telephone number of the Reclaimed Water Program Manager and all information in both English and Spanish.

Refer to Appendix E: Reclaimed Water Warning Sign for a sample sign. Signage of different design may be acceptable with County approval.

9.2.2. Employee Notification and Training

Each reclaimed water utility customer is responsible for ensuring that all personnel associated with the reclaimed water system are aware that reclaimed water is being used and are properly trained in its use and the facilities and equipment on their site. Section 10. Reclaimed Water Supervisor of Appendix A: Reclaimed Water Utility Customer Agreement requires that each reclaimed water utility customer designates a Reclaimed Water Supervisor as the person responsible for operating the reclaimed water system. The Reclaimed Water Supervisor is responsible for obtaining the necessary training as well as ensuring that all other applicable personnel are trained as well.

Information on reclaimed water such as the Reclaimed Water Informational Brochure or the Reclaimed Water Presentation may be available from the County but provide only general information. The customer's contract with the County (Appendix A: Reclaimed Water Utility Customer Agreement) also contains pertinent information but does not contain system-specific details that also must be part of the training program.

Every reclaimed water utility customer will have a unique set of conditions (application, size and complexity of system, system configuration, etc.) that makes it impossible to develop a single training program applicable to all customers. Therefore each reclaimed water utility customer is responsible for developing system-specific information and training for operating their own system.

10. CROSS-CONNECTION CONTROL AND BACKFLOW PREVENTION PROGRAM

Howard County follows the National Standard Plumbing Code Illustrated (2012 Edition the most recent edition) as the local plumbing code. Referring to it, section G.4. Alternate Water Sources for Non-Potable Applications, G.4.3. Reclaimed (Recycled) Water Systems is the applicable section for the reclaimed water system which includes requirements prohibiting connections to potable water systems and testing for cross-connections.

In terms of cross-connection control and backflow prevention, the National Standard Plumbing Code has requirements for activating a new reclaimed water connection and for regular inspection and testing. In order to approve a new reclaimed water connection to come on-line, the end user must first pass an initial cross-connection test of the site piping. Once a reclaimed water system is operating, the system is subject to annual cross-connection inspection and testing to verify that it still meets the requirements of the plumbing code.

For both the initial reclaimed water system start-up and the annual check-ups, the process consists of a visual inspection of the piping and an operational test of both the reclaimed water system and the potable water system. The visual inspection checks all piping and appurtenances for potential direct piped connections. The cross-connection test consists of depressurizing and draining the reclaimed water system while potable water system is still in operation to check if any flow still gets in to the reclaimed water system and then reversing the process with the potable water system depressurized and drained while the reclaimed water system is in service.

Appendix F: Reclaimed Water Utility Initial and Annual Inspection Checklist is the form used by the County inspector to verify that the customer's reclaimed water piping meets the County's requirements. This checklist must be filled out and approved by the inspector in order to activate a new reclaimed water account or to pass the annual inspection in order to continue to receive reclaimed water supply.

11. UPDATING RECLAIMED WATER MANAGEMENT PLAN

Whenever a new reclaimed water customer is added, the following items must be updated:

Figures:

Figure 2.2: Existing & Pending Reclaimed Water Customers

Tables:

Table 2.1: Existing & Pending Reclaimed Water Customers

Table 5.1: Reclaimed Water Balance

Table 5.2: Reclaimed Water Anticipated Demand by Existing & Pending Customers

Table 5.3: Reclaimed Water Demand by Reuse Category

GIS

RWM Plan: At least 30 days prior to connection, provide amendment to MDE informing them of the additional reclaimed water user(s).

Whenever a new reclaimed water line, reclaimed water pump station, or reclaimed water storage tank is added, the following items must be updated:

Figures:

Figure 3.1: Reclaimed Water System Existing and Scheduled Components

Figure 4.1: Reclaimed Water System Components

Tables:

Table 3.2: Reclaimed Water Distribution Mains

Table 3.3: Reclaimed Water Pumping Stations

Table 3.4: Reclaimed Water Storage Tanks

GIS

The following items must be updated annually:

Figures:

Figure 2.1: Existing, 5-Year, 10-Year, and Comprehensive Priorities for Reclaimed Water System Development (Figure 7.1 from Conceptual Reclaimed Water System Master Plan, Draft October 25, 2012)

Figure 2.3: Water Appropriation Permits (Figure 5.2 from Conceptual Reclaimed Water System Master Plan, Draft October 25, 2012)

Figure 6.1: 15 Highest Potable Water Users Calendar Year 2011 (Figure 5.4 from Conceptual Reclaimed Water System Master Plan, Draft October 25, 2012)

Tables:

Table 2.2: Existing Water Appropriation Permits within Metropolitan District

Table 2.3: Existing Water Appropriation Permits outside Metropolitan District

Table 3.1: Little Patuxent Water Reclamation Plant (LP WRP) Final Effluent Flow Rate

Baltimore County





















Anne Arundel County

Montgomery County

Prince George's
County

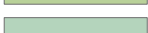
Fort Meade Reclaimed
Water Pumping Station
(located in Anne Arundel County)

RECLAIMED WATER FEATURES

MAINS		PRESSURE ZONES	
	RETURN SEWER		350_zone_PATAPSCO
	TRANSMISSION MAIN		400_Zone_PATAPSCO
FACILITIES			400_Zone_PATUXENT
	PUMPING STATION		550_II_Zone_PATAPSCO
	STORAGE TANK		550_II_Zone_PATUXENT
IMPROVEMENTS			550_I_Zone_PATAPSCO
	EXISTING OR SCHEDULED		550_I_Zone_PATUXENT
	0 - 5 YEARS		630_East_Zone_PATAPSCO
	6 - 10 YEARS		630_East_Zone_PATUXENT
	10+ YEARS		630_South_Zone_PATUXENT
			630_West_Zone_PATAPSCO
			630_West_Zone_PATUXENT
			630_West_Zone_PATUXENT
			730_Zone_PATUXENT

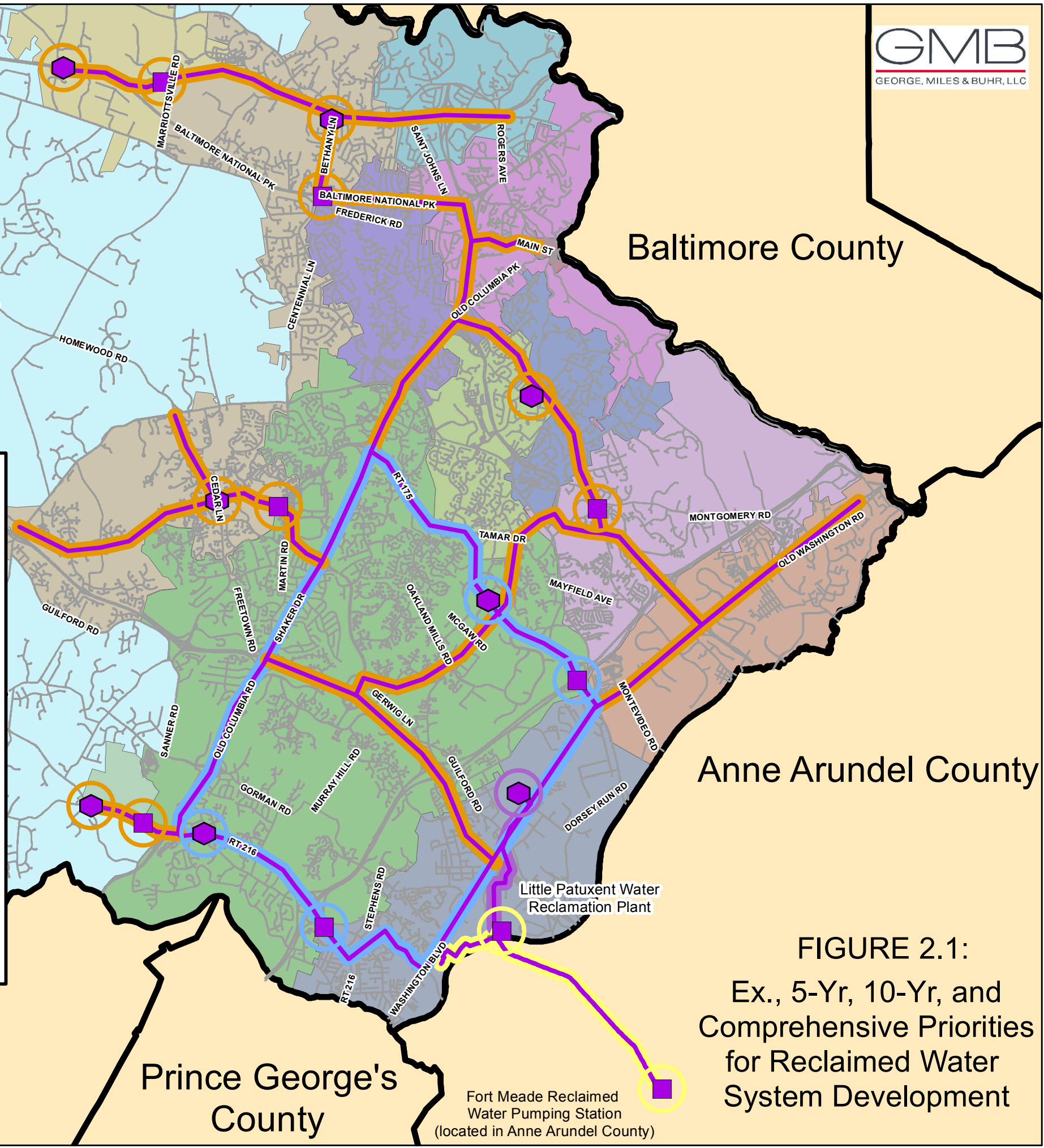

FIGURE 2.1:
Ex., 5-Yr, 10-Yr, and
Comprehensive Priorities
for Reclaimed Water
System Development

	COMPANY	ADDRESS	AVERAGE DAILY FLOW RATE (MGD)
1	FORT MEADE	2700 HERCULES RD, ANNAPOLIS JUNCTION, MD 20701	4.92
2	DREYER'S GRAND ICE CREAM, INC.	9090 WHISKEY BOTTOM RD, LAUREL, MD 20723	1.0
3	LAUREL SAND AND GRAVEL INC.	8422 WASHINGTON BLVD, JESSUP, MD 20794	0.5

Pending Customer
 Existing Customer

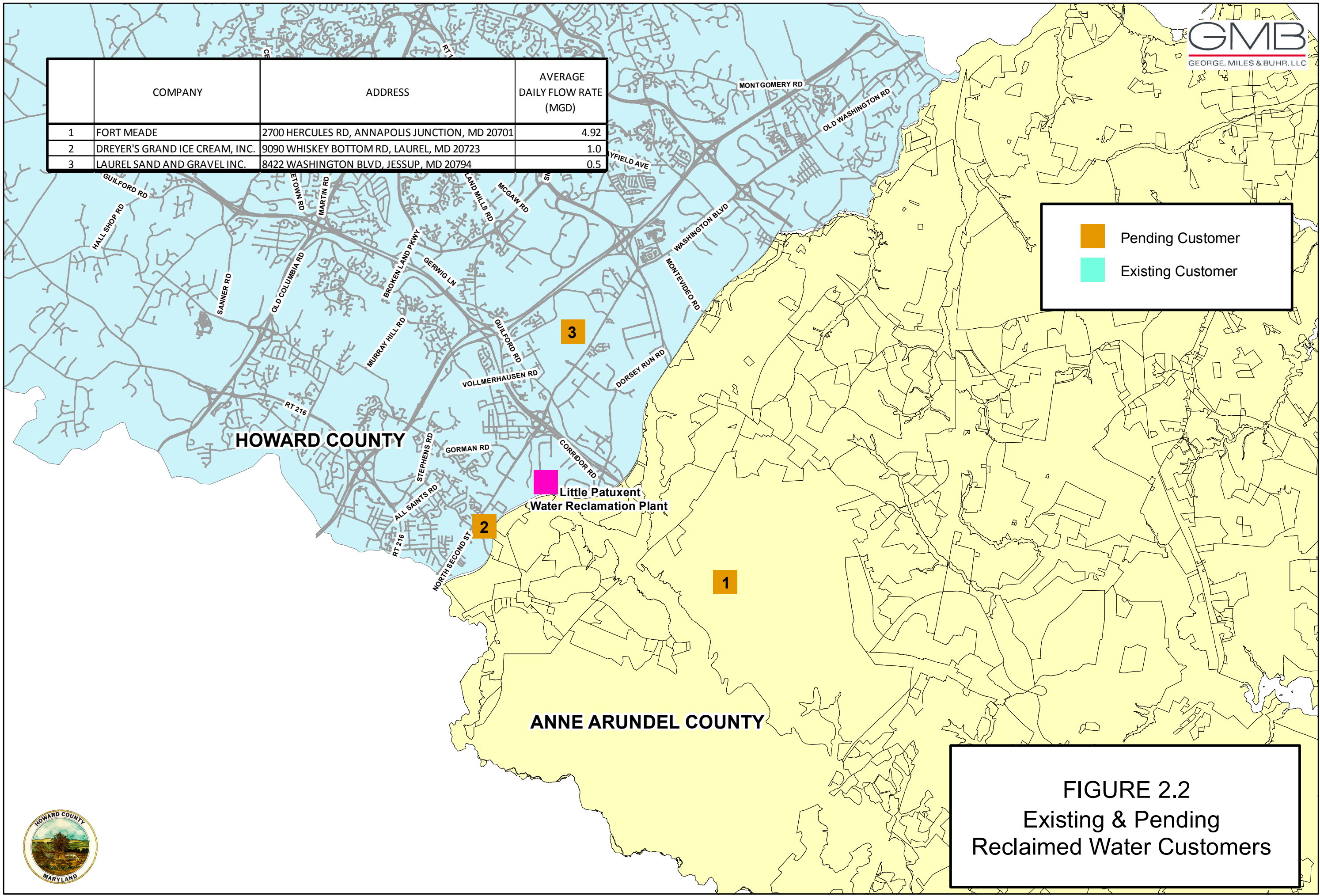

FIGURE 2.2
Existing & Pending
Reclaimed Water Customers



PERMIT USE TYPE

- POTABLE
- IRRIGATION
- COMMERCIAL
- Metropolitan District

(Data Year 2011)

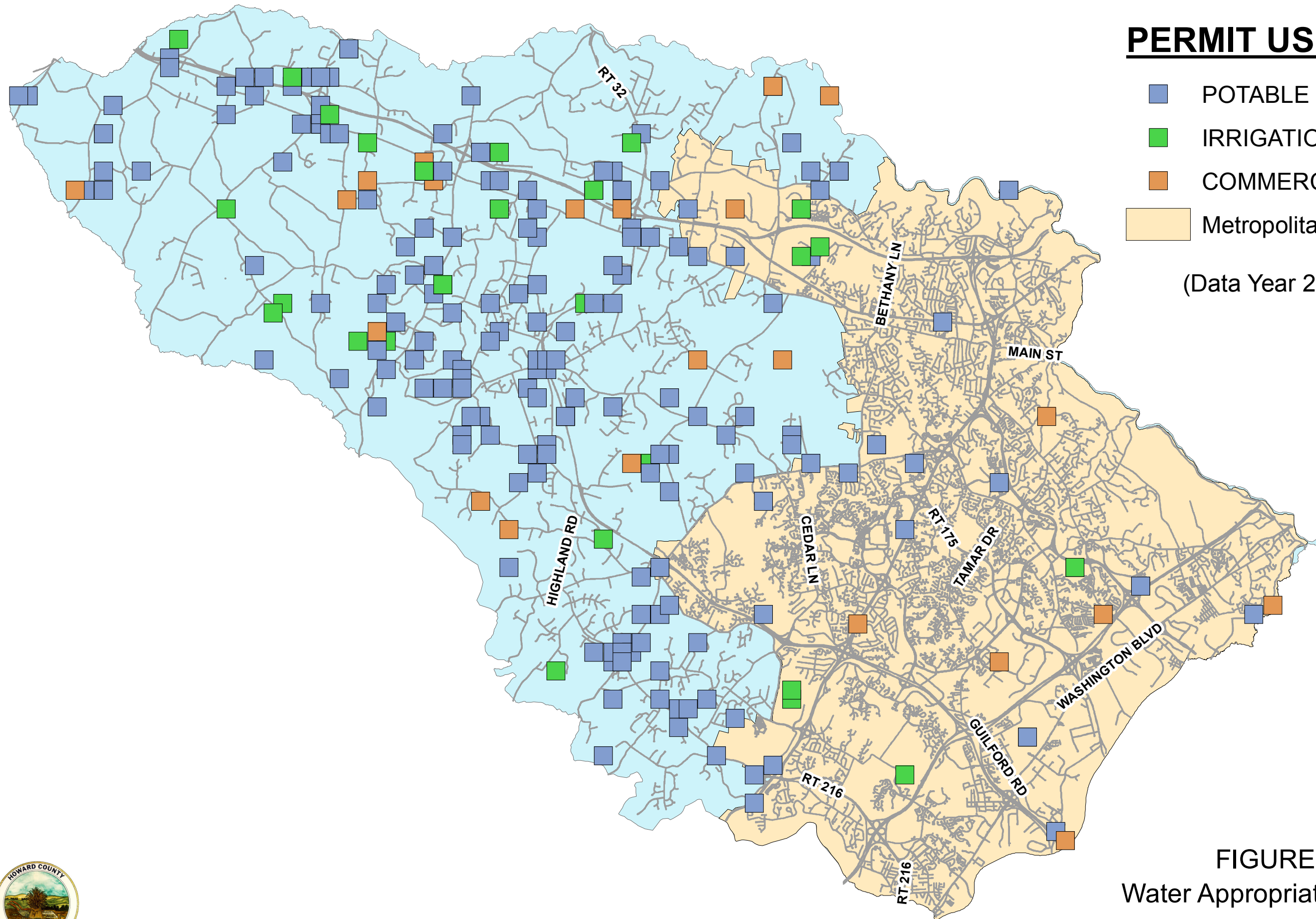

FIGURE 2.3:
Water Appropriation Permits

HOWARD COUNTY

ANNE ARUNDEL COUNTY



RECLAIMED WATER FEATURES

IMPROVEMENTS

- EXISTING OR SCHEDULED
- 0 - 5 YEARS

FACILITIES

- PUMPING STATION
- STORAGE TANK

MAINS

- RETURN SEWER
- TRANSMISSION MAIN

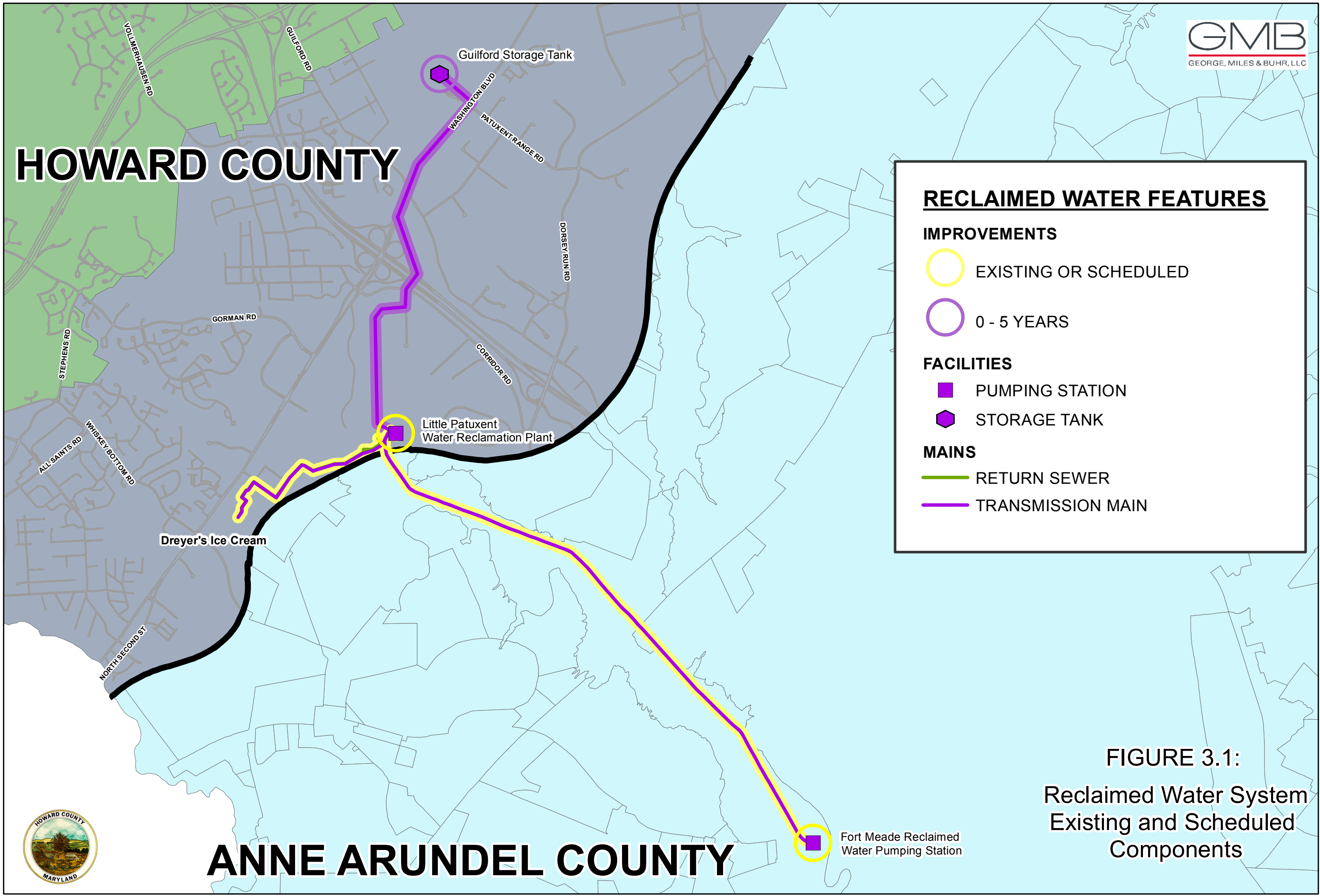

FIGURE 3.1:
Reclaimed Water System
Existing and Scheduled
Components

RANK	COMPANY	ADDRESS	AVERAGE DAILY FLOW RATE (GPD)
1	TAYLOR FARMS MARYLAND	9055 JUNCTION DR, ANNAPOLIS JCT	355,009
2	MD & VA MILK PRODUCERS	8321 LEISHEAR RD, LAUREL	195,206
3	DREYERS ICE CREAM-NESTLE	9090 WHISKEY BOTTOM RD, LAUREL	188,804
4	THE ROUSE COMPANY	10300 LITTLE PATUXENT PKWY, COLUMBIA	169,061
5	STATE OF MD PATUXENT INST	ROUTE 175, JESSUP	108,450
6	MD FOOD CENTER AUTHORITY	7901 OCEANO AVE, JESSUP	97,986
7	COASTAL SUNBELT PRODUCE	8704 BOLLMAN PL, SAVAGE	97,408
8	HOWARD CO GEN HOSPITAL	5755 CEDAR LN, COLUMBIA	96,949
9	JHU/APL BLDG 13-S307	11100 JOHNS HOPKINS RD, LAUREL	89,724
10	STATE OF MD PATUXENT INST	ROUTE 175, JESSUP	78,316
11	DREYERS ICE CREAM-NESTLE	9090 WHISKEY BOTTOM RD, LAUREL	75,235
12	DREYERS ICE CREAM-NESTLE	9090 WHISKEY BOTTOM RD, LAUREL	72,927
13	W R GRACE & CO	7500 GRACE DR, COLUMBIA	66,496
14	LANCASTER FOODS INC	7700 CONOWINGO AVE, JESSUP	65,707
15	DEEP RUN ASSOCIATES	6551 OLD WATERLOO RD, ELKRIDGE	41,645

CALENDAR YEAR 2011

- 15 Highest Potable Water Users
- Metropolitan District

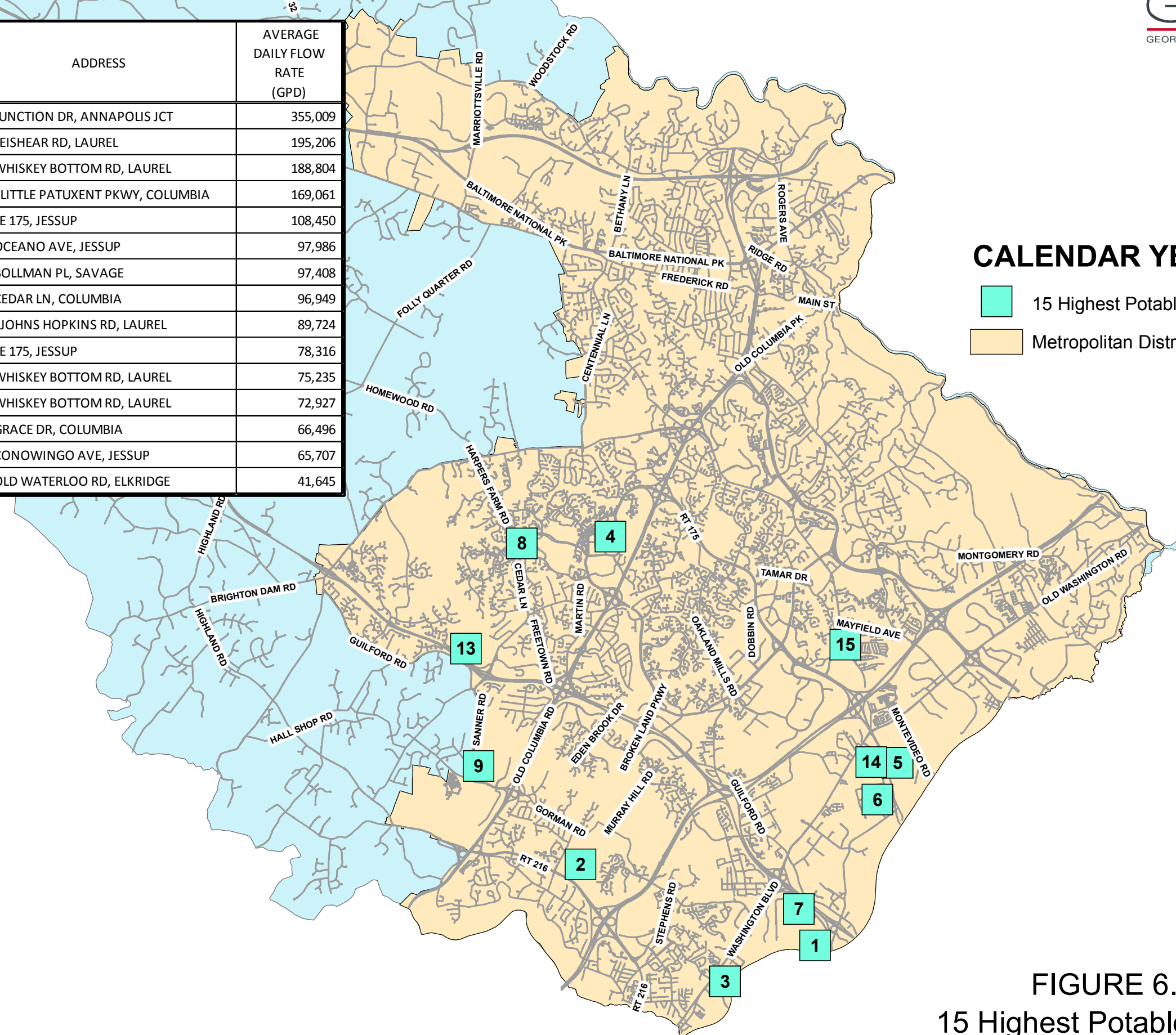

FIGURE 6.1
 15 Highest Potable Water Users Calendar Year 2011

Table 2.1.a: Existing & Pending Reclaimed Water Customers - Customer Information

Customer (-)	Street Address of Site (-)	City, State, Zip Code of Site (-)	Contact (-)	Contact Telephone Number (-)	Emergency / After-Hours Telephone Number (-)	Contact E-Mail Address (-)	Agreement Implementation Date (mm/dd/yyyy)	Agreement Expiration Date (mm/dd/yyyy)	Initial Inspection Date (mm/dd/yyyy)	Next Scheduled Inspection Date (mm/dd/yyyy)	Purpose of Use (-)	Reuse Category (-)	Minimum Reclaimed Water Quality Classification Required:
Fort Meade	2700 Hercules Road	Annapolis Junction, MD 20701									Cooling / Cooling Tower	COM	IV
Dreyer's Grand Ice Cream, Inc.	9090 Whiskey Bottom Road	Laurel, MD 20723									Cooling / Cooling Tower	COM	IV
Laurel Sand and Gravel Inc.	8422 Washington Boulevard	Jessup, MD 20794									Manufacturing / Cleaning	IND	IV



Typical Purposes of Use

- Cooling / Cooling Tower
- Manufacturing / Process
- Fire Protection
- Manufacturing / Cleaning
- Maintenance / Cleaning
- Irrigation (Landscape)
- Irrigation (Agricultural)

Reuse Categories

- IRW: Irrigation - Restricted Access with Wider Buffer Zone (Class I minimum)
- IRN: Irrigation - Restricted Access with Narrower Buffer Zone (Class II minimum)
- IUO: Irrigation - Unrestricted Access and Other Restricted Uses (Class III minimum)
- ILO: Residential Lawn Irrigation / Other Unrestricted Access Water Reuses (Class IV minimum)
- COM: Commercial (Class IV minimum)
- IND: Industrial (Class IV minimum)

Source: MDE Guidelines for Use of Reclaimed Water, Draft 6-11-2012, Table 1 - Class of Reclaimed Water Suitable for Various Types of Water Reuses

Table 2.2: Existing Water Appropriation Permits within Metropolitan District

Refer to Figure 2.3: Water Appropriation Permits

Data Year 2011

Owner (-)	Remarks (-)	Average Daily Flow Rate (gpd)	Maximum Month Average Daily Flow Rate (gpd)	Type of Use (-)	Water Appropriation Permit Number (-)	Effective Date (Year)	Area (-)	Northing Coordinate (-)	Easting Coordinate (-)	Groundwater Aquifer (-)	GIS Identifier (-)
JHU APPLIED PHYSICS LAB	IRRIGATION	1,000	5,000	Irrigation	HO1952G002	2001	Metro District	486,000	830,000	WISSAHICKON FORMATION	1
W. R. GRACE & CO.	WASHINGTON RESEARCH CENTER	70,000	140,000	Potable	HO1955G001	2006	Metro District	495,000	827,000	LOWER PELITIC SCHIST WISSAHICKON	2
KONTERA LIMITED PARTNERSHIP	LAUREL SAND & GRAVEL PLANT	500	1,000	Commercial	HO1958G001	2005	Metro District	496,000	881,000	PATUXENT FORMATION	3
MANGIONE ENTERPRISES OF TURF VALLEY	TURF VALLEY GOLF COURSE	2,000	5,000	Potable	HO1958G006	1993	Metro District	533,000	832,000	COCKEYSVILLE MARBLE	4
RONO RURAL ENTERPRISES, INC.	DRIVING RANGE	500	20,000	Potable	HO1965G003	2002	Metro District	475,000	826,000	LOWER PELITIC SCHIST WISSAHICKON	11
SEVENTH DAY ADVENTISTS	SANITARY USE ONLY ON PUBLIC SEWER	400	600	Commercial	HO1966G012	2002	Metro District	494,000	837,000	LOWER PELITIC SCHIST WISSAHICKON	14
NERI, LUIGI, AND ANNA	ANNAPOLIS JUNCTION POST OFFICE	500	600	Potable	HO1967G010	1998	Metro District	472,000	858,000	PATUXENT FORMATION	19
AGGREGATE INDUSTRIES, ,	MANUFACTURE CINDER BLOCKS	700	900	Commercial	HO1969G002	2010	Metro District	471,000	859,000	PATUXENT FORMATION	21
EXXON MOBIL CORPORATION	EXXON STATION NO 27459	500	800	Potable	HO1971G006	2001	Metro District	500,000	816,000	BALTIMORE GNEISS	22
GARY MEMORIAL UNITED METHODIST		100	300	Potable	HO1974G019	2002	Metro District	540,000	853,000	LOWER PELITIC SCHIST WISSAHICKON	32
HOWARD CO DEPT RECREATION	CENTENNIAL PARK	1,000	2,500	Potable	HO1976G001	1998	Metro District	513,000	839,000	LOWER PELITIC SCHIST WISSAHICKON	35
LANEVE, RONALD, S.	CEASAR'S III RESTAURANT	2,000	2,600	Potable	HO1982G003	1998	Metro District	533,000	820,000	SETTERS FORMATION	50
IGENE BIOTECHNOLOGY		250	500	Potable	HO1983G006	2005	Metro District	509,000	852,000	LOWER PELITIC SCHIST WISSAHICKON	54
GROUP 5 PARTNERSHIP,	PATRICK CLARK & ASSOC. INSURANCE	100	200	Potable	HO1986G009	2002	Metro District	480,000	822,000	LOWER PELITIC SCHIST WISSAHICKON	61
CREST LAWN MEMORIAL GARDENS, INC.	CEMETERY OFFICE	800	1,200	Potable	HO1987G007	2001	Metro District	538,000	819,000	WISSAHICKON FORMATION	66
SUNOCO, INC., ,	STATION # 0003-4587	1,000	3,000	Potable	HO1988G007	2009	Metro District	526,000	846,000	BALTO. GABBRO COMPLEX	72
COLUMBIA ASSOCIATION, INC.	HOBBIT'S GLEN GOLF CLUB	52,000	350,000	Potable	HO1988S017	2007	Metro District	507,000	827,000	MIDDLE PATUXENT RIVER	76
HOWARD COUNTY GOVERNMENT	TIMBERS AT TROY GOLF COURSE	71,000	260,000	Potable	HO1990G017	2008	Metro District	498,000	867,000	BALTO. GABBRO COMPLEX	87
ROLLINS, RICHARD	HANOVER AUTO BODY	300	500	Potable	HO1990G019	2003	Metro District	495,000	879,000	PATUXENT FORMATION	88
HOWARD COUNTY GOVERNMENT	TIMBERS AT TROY GOLF COURSE	3,600	7,300	Potable	HO1990S017	2008	Metro District	498,000	867,000	DEEP CREEK	91
HOWARD COUNTY DPW	COUNTY HIGHWAY MAINTENANCE FACILITY	7,200	9,000	Commercial	HO1992G003	2007	Metro District	495,000	863,000	BALTO. GABBRO COMPLEX	97
MANGIONE ENTERPRISES OF TURF VALLEY	TURF VALLEY GOLF COURSE	113,000	311,000	Irrigation	HO1992G015	2000	Metro District	534,000	833,000	COCKEYSVILLE MARBLE	100
10010 GORMAN ROAD, LLC	IRRIGATION	43,000	92,000	Irrigation	HO1992S006	2010	Metro District	478,000	842,000	MIDDLE PATUXENT RIVER	104
COLUMBIA ASSOCIATION, INC.	FAIRWAY HILLS GOLF COURSE	45,000	250,000	Potable	HO1992S010	2005	Metro District	511,000	843,000	LITTLE PATUXENT RIVER	107
MANGIONE ENTERPRISES OF TURF VALLEY	GOLF COURSE IRRIGATION - CHANGE	40,000	580,000	Irrigation	HO1993S008	2000	Metro District	533,000	831,000	LITTLE PATUXENT RIVER	117
WAVERLY WOODS GOLF CLUB, L.L.C.	WAVERLY WOODS IRRIGATION WELL(S)	14,000	72,000	Irrigation	HO1994G003	2006	Metro District	538,000	831,000	BALTIMORE GNEISS	119
WAVERLY WOODS GOLF CLUB, L.L.C.	IRRIGATION POND	60,000	450,000	Irrigation	HO1994S003	2006	Metro District	538,000	831,000	DAVIS BRANCH	121
HOWARD COUNTY DPW	HOWARD COUNTY ALPHA RIDGE LANDFILL	252,000	288,000	Commercial	HO1997G001	2009	Metro District	538,000	824,000	BALTIMORE GNEISS	127
GENERAL ELECTRIC COMPANY	GROUND WATER REMEDIATION	8,000	10,000	Commercial	HO1997G014	2009	Metro District	490,000	852,000	BALTO. GABBRO COMPLEX	130
HOWARD CO BUR ENVIRONMENTAL	HO CO DPW NEW CUT LF REMEDIATION	94,000	144,000	Commercial	HO1998G002	2010	Metro District	516,000	857,000	BALTO. GABBRO COMPLEX	134
MANYARA, SYMON, M.	RESIDENCE	2,000	3,000	Potable	HO1999G003	1999	Metro District	533,000	824,000	BALTIMORE GNEISS	142
COLUMBIA PARK & RECREATION ASSOC	PARK & RECREATION	800	2,000	Potable	HO1999S009	1999	Metro District	504,000	842,000	UNNAMED TRIBUTARY	150
HOWARD COUNTY DEPT. RECREATION	PARK OPERATIONS	500	2,200	Potable	HO1999S011	1999	Metro District	513,000	839,000	UNNAMED TRIB	151
EDDY'S WELDING	EDDY'S WELDING	1,000	1,500	Potable	HO2000G002	2000	Metro District	540,000	853,000	COCKEYSVILLE MARBLE	153
BUCH, JR., JAMES, R.	BUCH CONSTRUCTION CONTRACTOR	300	500	Potable	HO2000G008	2000	Metro District	479,000	828,000	LOWER PELITIC SCHIST WISSAHICKON	158
MOUNT VIEW, LLC	47 LOT PINDELL WOODS SBDN	10,000	17,000	Potable	HO2000G012	2000	Metro District	484,000	824,000	LOWER PELITIC SCHIST WISSAHICKON	160
CHASE MINING, LLC.	CHASE MINING	280,000	698,000	Potable	HO2002G013	2003	Metro District	482,000	855,000	BALTO. GABBRO COMPLEX	183
CHASE MINING, LLC.	CHASE MINING	120,000	4,100,000	Potable	HO2002S113	2003	Metro District	482,000	855,000		189
HOWARD COUNTY CONSERVANCY	HOWARD COUNTY CONSERVANCY, INC.	600	1,200	Potable	HO2003G012	2003	Metro District	540,000	833,000	BALTIMORE GNEISS	200
RUTAN, ROBERT	PRIVATE RESIDENCE DEWATERING	8,500	20,000	Potable	HO2006G001	2008	Metro District	510,000	836,000	LOWER PELITIC SCHIST WISSAHICKON	218
JOHNS HOPKINS UNIV./APL	COOLING WATER, IRRIGATION, BACKUP	5,000	10,000	Irrigation	HO2008G004	2008	Metro District	487,000	830,000	LOWER PELITIC SCHIST WISSAHICKON	242
STATE HIGHWAY ADMINISTRATION	WATER FOR DRILLING AND CORING	300	1,000	Commercial	HO2008S008	2008	Metro District	500,000	860,000	PATUXENT RIVER	247
RED HILL LAWN SERVICE, INC.	HYDROSEEDING	1,500	6,000	Irrigation	HO2008S009	2008	Metro District	500,000	860,000	PATUXENT RIVER	248

Owner (-)	Remarks (-)	Average Daily Flow Rate (gpd)	Maximum Month Average Daily Flow Rate (gpd)	Type of Use (-)	Water Appropriation Permit Number (-)	Effective Date (Year)	Area (-)	Northing Coordinate (-)	Easting Coordinate (-)	Groundwater Aquifer (-)	GIS Identifier (-)
		1,314,950									

Table 2.3: Existing Water Appropriation Permits outside Metropolitan District

Refer to Figure 2.3: Water Appropriation Permits

Data Year 2011

Owner (-)	Remarks (-)	Average Daily Flow Rate (gpd)	Maximum Month Average Daily Flow Rate (gpd)	Type of Use (-)	Water Appropriation Permit Number (-)	Effective Date (Year)	Area (-)	Northing Coordinate (-)	Easting Coordinate (-)	Groundwater Aquifer (-)	GIS Identifier (-)
WILLIAMS TRANSCO PIPELINE BOARMAN, FLORENTINE J.	COMPRESSOR STATION 190 - ELLICOT CITY BOARMAN'S MARKET	500	1,000	Commercial	HO1950G001	2006 Rural		522,000	820,000	LOWER PELITIC SCHIST WISSAHICKON	0
MARYLAND STATE HIGHWAY ADMIN	SHA GARAGE AT DAYTON	1,600	2,700	Potable	HO1962G005	2007 Rural		516,000	806,000	LOWER PELITIC SCHIST WISSAHICKON	6
HOWARD COUNTY FAIR ASSOCIATION, INC.	COUNTY FAIRGROUNDS	1,000	25,000	Commercial	HO1963G001	2007 Rural		538,000	807,000	BOULDER GNEISS WISSAHICKON FORM.	7
WESTMINSTER UNION BANK	BANK	200	300	Potable	HO1963G004	2002 Rural		552,000	781,000	WISSAHICKON FORMATION	8
CONVENTUAL FRANCISCAN FRIARS	FRANCISCAN FRIAR RESIDENCE	1,500	2,300	Potable	HO1963G006	2001 Rural		518,000	817,000	LOWER PELITIC SCHIST WISSAHICKON	9
SISTERS OF BON SECOURS USA	RETREAT HOUSE & CONVENT	17,000	22,000	Potable	HO1963G008	2010 Rural		545,000	830,000	SWIFT RUN FORMATION	10
ROWAN PROPERTIES, LLC	POOL & LANDSCAPE OFFICE	300	500	Potable	HO1965G011	2002 Rural		550,000	773,000	WISSAHICKON FORMATION	12
MT. AIRY HOWARD CHAPEL CHURCH, ,		100	500	Potable	HO1966G006	1998 Rural		540,000	755,000	IJAMSVILLE FORM.-MARBURG SCHIST	13
HOWARD COUNTY PUBLIC SCHOOLS	GLENWOOD M. S.	5,000	7,000	Potable	HO1967G001	2005 Rural		532,000	792,000	BOULDER GNEISS WISSAHICKON FORM.	15
CROOKS, AMY, R.	COUNTRY KETTLE RESTAURANT	1,000	1,200	Potable	HO1967G006	2002 Rural		551,000	770,000	WISSAHICKON FORMATION	16
NIXON'S FARM, INC.,	NIXON'S FARM - SPECIAL EVENTS	250	1,000	Potable	HO1967G007	2002 Rural		532,000	811,000	LOWER PELITIC SCHIST WISSAHICKON	17
WARFIELD, KENNARD J.	OLD TYME LIQUORS	100	200	Potable	HO1967G008	2002 Rural		521,000	804,000	LOWER PELITIC SCHIST WISSAHICKON	18
BROWN'S CHAPEL, UNITED METHODIST	BROWNS CHAPEL, UMC	100	200	Potable	HO1968G001	2001 Rural		512,000	802,000	LOWER PELITIC SCHIST WISSAHICKON	20
CISSEL PROPERTIES,	LISBON TECH CENTER	200	300	Potable	HO1971G009	2002 Rural		547,000	780,000	WISSAHICKON FORMATION	23
DAYTON ROD AND GUN CLUB INC.	CLUB -	100	200	Potable	HO1972G002	2004 Rural		509,000	801,000	LOWER PELITIC SCHIST WISSAHICKON	24
HOWARD COUNTY PUBLIC SCHOOLS	GLENELG H. S.	7,100	10,300	Potable	HO1973G003	2003 Rural		525,000	799,000	BOULDER GNEISS WISSAHICKON FORM.	25
HOWARD COUNTY PUBLIC SCHOOLS	LISBON E. S.	2,500	3,000	Potable	HO1973G004	2005 Rural		547,000	780,000	WISSAHICKON FORMATION	26
HOWARD COUNTY PUBLIC SCHOOLS	WEST FRIENDSHIP E. S.	1,500	2,000	Potable	HO1973G006	2005 Rural		535,000	815,000	LOWER PELITIC SCHIST WISSAHICKON	27
FAITH COMMUNITY CHURCH		300	500	Potable	HO1973G011	2005 Rural		549,000	758,000	IJAMSVILLE FORM.-MARBURG SCHIST	28
LIBERTY BAPTIST CHURCH	CHURCH	100	300	Potable	HO1974G001	2002 Rural		548,000	780,000	WISSAHICKON FORMATION	29
FERGUSON, SR, JAMES, R.	SAND & GRAVEL HAULING	250	500	Commercial	HO1974G002	2006 Rural		543,000	791,000	WISSAHICKON FORMATION	30
UNIVERSITY OF MARYLAND	RESEARCH, EXTENSION, AND EDUCATION	10,000	16,000	Potable	HO1974G003	2006 Rural		516,000	820,000	LOWER PELITIC SCHIST WISSAHICKON	31
THE ROMAN CATHOLIC ARCHBISHOP	CHURCH HALL	800	1,000	Potable	HO1975G003	2003 Rural		548,000	770,000	METAGABBRO AND AMPHIBOLITE	33
GLENELG COUNTRY SCHOOL	SCHOOL POTABLE, COOLING, IRRIGATION	8,000	12,000	Potable	HO1975G009	2008 Rural		517,000	811,000	SETTERS FORMATION	34
HOWARD COUNTY DPW	COOKSVILLE HIGHWAY MAINTENANCE	1,000	1,500	Commercial	HO1976G007	2001 Rural		541,000	798,000	BOULDER GNEISS WISSAHICKON FORM.	36
O'DONNELL AND COMPANY	JOHN S. WILSON COMPANY	400	600	Commercial	HO1977G005	2002 Rural		538,000	812,000	ULTRAMAFIC ROCKS	37
THE ARC OF HOWARD COUNTY	NON PROFIT SPECIAL NEEDS CENTER	500	700	Potable	HO1978G003	2002 Rural		514,000	823,000	BALTIMORE GNEISS	38
INTERMEDIA COMMUNICATIONS INC.	TOWER AND MAINT FACILITY UNMANNED	100	100	Commercial	HO1978G005	2002 Rural		541,000	792,000	WISSAHICKON FORMATION	39
MOUNT AIRY BIBLE CHURCH	CHURCH & SCHOOL	2,000	4,000	Potable	HO1979G005	2005 Rural		552,000	772,000	WISSAHICKON FORMATION	40
VINCI, AGOSTINO, JOSEPH	VINCI STONE PRODUCTS, INC.	300	500	Commercial	HO1980G001	2001 Rural		551,000	828,000	COCKEYSVILLE MARBLE	41
WARD, RYAN, G	IRRIGATION OF NURSERY STOCK	2,300	9,200	Irrigation	HO1980G003	2005 Rural		545,000	785,000	WISSAHICKON FORMATION	42
VINCI, AGOSTINO, J.	DUST CONTROLL STONE QUARRY	4,000	7,500	Commercial	HO1980S001	2002 Rural		551,000	828,000	SOUTH BRANCH	43
LISBON UNITED METHODIST CHURCH	CHURCH/DAY CARE	500	800	Potable	HO1981G003	2001 Rural		546,000	781,000	WISSAHICKON FORMATION	44
ARMSTRONG, WILLIAM	GWHP	3,000	6,000	Commercial	HO1981G004	2004 Rural		504,000	800,000	LOWER PELITIC SCHIST WISSAHICKON	45
BROWN, GEORGE AND JUDITH	CHANGE OF ADDRESS	4,500	7,500	Potable	HO1981G005	1999 Rural		554,000	764,000	IJAMSVILLE FORM.-MARBURG SCHIST	46
GLYNN, JAMES C.	SMALL BUSINESS OFFICE	100	200	Potable	HO1981G006	2004 Rural		490,000	812,000	BALTIMORE GNEISS	47
EYRE, RONALD L.	EYRE BUS SERVICE	2,000	2,500	Potable	HO1981G007	2003 Rural		521,000	803,000	LOWER PELITIC SCHIST WISSAHICKON	48
TRANSCONTINENTAL GAS PIPELINE	HYDROSTATIC PRESSURE TEST	18,000	3,100,000	Commercial	HO1981S005	2003 Rural		522,000	829,000	MIDDLE PATUXENT RIVER	49
HOWARD COUNTY DPW	DAYTON HIGHWAY MAINTENANCE SHOP	800	1,000	Potable	HO1982G004	2005 Rural		516,000	806,000	LOWER PELITIC SCHIST WISSAHICKON	51
WEST HOWARD COUNTY SWIM CLUB	SWIMMING POOL	500	2,000	Potable	HO1983G001	1993 Rural		552,000	779,000	WISSAHICKON FORMATION	52
CALVARY LUTHERAN CHURCH	CHURCH-CALVARY LUTHERAN	1,000	1,700	Potable	HO1983G004	2006 Rural		551,000	777,000	WISSAHICKON FORMATION	53
HO CO PUBLIC SCHOOLS	BUSHY PARK ELEMENTARY SCHOOL	3,500	5,000	Potable	HO1983G008	2007 Rural		534,000	789,000	BOULDER GNEISS WISSAHICKON FORM.	55

Owner (-)	Remarks (-)	Average Daily	Maximum	Type of Use (-)	Water	Effective	Area	Northing	Easting	Groundwater Aquifer (-)	GIS Identifier (-)
		Flow Rate (gpd)	Month Average Daily Flow Rate (gpd)		Appropriation Permit Number (-)						
SHEPHERD OF THE GLEN LUTHERAN COMMUNITY BIBLE CHURCH HIGHLAND	CHURCH	200	500	Potable	HO1984G001	2006 Rural		527,000	794,000	BOULDER GNEISS WISSAHICKON FORM.	56
HO CO DEPARTMENT OF RECREATION	LAND PRESERVATION FUND	200	300	Potable	HO1984G009	1996 Rural		542,000	811,000	BOULDER GNEISS WISSAHICKON FORM.	58
FESTERLING, JOACHIM, HOWARD COUNTY RECREATION	LINDENHOF NURSERY	800	3,500	Potable	HO1984G013	2006 Rural		538,000	803,000	BOULDER GNEISS WISSAHICKON FORM.	59
LISBON VOLUNTEER FIRE CO	SCHOOLEY MILL PARK	600	2,400	Potable	HO1985G001	1997 Rural		486,000	811,000	GUNPOWDER GRANITE	60
HARIG	FIRE COMPANY	200	1,000	Potable	HO1986G012	1998 Rural		547,000	778,000	WISSAHICKON FORMATION	62
HARIG	OFFICES, NEW RESTAURANT, GYM	1,850	3,500	Potable	HO1986G013	2007 Rural		522,000	803,000	LOWER PELITIC SCHIST WISSAHICKON	63
MIKOLASKO, ERIC, J.	WASHINGTONIAN LANDSCAPE CO.	600	2,400	Potable	HO1987G003	1999 Rural		542,000	761,000	IJAMSVILLE FORM.-MARBURG SCHIST	64
LISBON PLAZA, LLC	LISBON SHOPPING CENTER WELL	10,000	14,500	Potable	HO1987G005	2003 Rural		552,000	781,000	WISSAHICKON FORMATION	65
WALKER, STEPHEN T.	TRUSTED INFORMATION SYSTEMS, INC.	1,400	2,000	Potable	HO1987G009	1999 Rural		529,000	792,000	BOULDER GNEISS WISSAHICKON FORM.	67
CRANE, DONALD E.,	CHANGE OF ADDRESS	3,000	5,000	Potable	HO1987G010	1999 Rural		519,000	802,000	ULTRAMAFIC ROCKS	68
WALLY'S IRON WORKS, INC.	ORNAMENTAL FABRICATION SHOP	200	300	Potable	HO1987G012	1999 Rural		553,000	764,000	IJAMSVILLE FORM.-MARBURG SCHIST	69
CAMPBELL, DONALD & KAREN	GROUND WATER HEAT PUMP	2,000	4,000	Commercial	HO1987G015	1999 Rural		531,000	812,000	LOWER PELITIC SCHIST WISSAHICKON	70
WILLOW SPRINGS I LIMITED PARTNER	GOLF COURSE IRRIGATION - 3 WELLS	20,000	125,000	Irrigation	HO1988G003	2001 Rural		540,000	809,000	BOULDER GNEISS WISSAHICKON FORM.	71
WILLOW SPRINGS I LIMITED PARTNER	WILLOW SPRINGS CLUB HOUSE	1,000	2,000	Potable	HO1988G103	2001 Rural		540,000	809,000	BOULDER GNEISS WISSAHICKON FORM.	73
SNELL, DAVID R.,	SNELL'S NURSERY	1,300	5,200	Potable	HO1988S001	1999 Rural		550,000	749,000	UNNAMED TRIBUTARY	74
WILLOW SPRINGS I LIMITED PARTNERSHIP	GOLF COURSE IRRIGATION, SPRING PONDS	15,000	200,000	Irrigation	HO1988S003	2001 Rural		540,000	809,000	UNNAMED TRIB	75
THOMPSON, CARL A. & SANDY, A.	RESIDENTIAL GWHP - RECHARGE WELL	3,000	6,000	Commercial	HO1989G003	2001 Rural		507,000	797,000	LOWER PELITIC SCHIST WISSAHICKON	77
MANFUSO, KATHARINE VOSS & ROBERT	CHANCELAND HORSE FARM	1,400	2,000	Potable	HO1989G007	2001 Rural		540,000	802,000	BOULDER GNEISS WISSAHICKON FORM.	78
TARO INVESTMENT CORPORATION	BRICK HOUSE FARM BOTTLED WATER	116,000	152,000	Potable	HO1989G016	2006 Rural		512,000	817,000	COCKEYSVILLE MARBLE	79
FRIENDSHIP BAPTIST CH OF SYKESVILLE	CHURCH.	300	500	Potable	HO1989G017	2002 Rural		546,000	814,000	BOULDER GNEISS WISSAHICKON FORM.	80
TURNER, DANIEL, C.	NURSERY STOCK IRRIGATION	100	500	Irrigation	HO1989S006	2001 Rural		489,000	805,000	PATUXENT RIVER	81
SHARP, CHARLES	FARM IRRIGATION 280 ACRES	152,000	1,000,000	Irrigation	HO1989S014	2001 Rural		524,000	784,000	CATTAIL CREEK	82
HEALEY, DAVID AND MARIANNE	GREENHOUSE AND CONTAINER NURSERY	3,000	12,000	Irrigation	HO1990G002	2002 Rural		544,000	799,000	EARLY PALEOZOIC-LATE PC UNDF.	83
WARFIELD, JR, KENNARD,	WARFIELD-43 LOT SBDN	9,200	15,300	Potable	HO1990G013	2002 Rural		514,000	795,000	BOULDER GNEISS WISSAHICKON FORM.	84
WARFIELD, JR., KENNARD,	12-LOT SBDN	2,600	4,300	Potable	HO1990G014	2002 Rural		516,000	797,000	BOULDER GNEISS WISSAHICKON FORM.	85
CATTAIL CREEK COUNTRY CLUB, INC.	CATTAIL CREEK GOLF COURSE	42,000	300,000	Potable	HO1990G016	2001 Rural		525,000	787,000	BOULDER GNEISS WISSAHICKON FORM.	86
J. LONDON REEVE	IRRIGATION AT LANDSCAPE COMPANY.	4,500	18,000	Irrigation	HO1990S003	2002 Rural		528,000	776,000	CATTAIL CREEK	89
CATTAIL CREEK COUNTRY CLUB, INC.	CATTAIL CREEK GC - MAIN POND	43,000	288,000	Irrigation	HO1990S016	2001 Rural		524,000	787,000	EAST BRANCH	90
ERIK ROSENBAUM	POTABLE & SANITARY USES, NURSERY	16,000	60,000	Potable	HO1991G016	2010 Rural		542,000	791,000	WISSAHICKON FORMATION	92
CHAPEL VALLEY LANDSCAPE COMPANY	NURSERY STOCK IRRIGATION	3,500	5,000	Irrigation	HO1991S004	2004 Rural		527,000	775,000	CATTAIL CREEK	93
ERIK ROSENBAUM	NURSERY IRRIGATION RUNOFF POND	5,000	15,000	Irrigation	HO1991S016	2010 Rural		542,000	791,000	CATTAIL CREEK	94
ERIK ROSENBAUM	NURSERY STOCK IRRIGATION - SPRING	5,000	15,000	Irrigation	HO1991S116	2010 Rural		542,000	791,000	CATTAIL CREEK	95
WARREN H. BOYER, INC., ,	WELL THAT FEEDS POND	2,000	7,000	Irrigation	HO1992G002	2004 Rural		530,000	793,000	BOULDER GNEISS WISSAHICKON FORM.	96
MCKENDREE ASSOCIATES LLC,	GREENHOUSE & FIELD IRRIGATION	7,000	9,000	Irrigation	HO1992G008	2004 Rural		538,000	799,000	BOULDER GNEISS WISSAHICKON FORM.	98
STEDDING, WILLIAM, M.	GREEN MANOR TURF FARM	34,000	100,000	Irrigation	HO1992G009	2004 Rural		545,000	813,000	BOULDER GNEISS WISSAHICKON FORM.	99
WARREN H. BOYER, INC.	WELL FOR SHOP AND OFFICE	100	1,000	Potable	HO1992G202	2004 Rural		530,000	793,000	BOULDER GNEISS WISSAHICKON FORM.	101
WARREN H. BOYER, INC.	NURSERY STOCK IRRIGATION	2,000	20,000	Irrigation	HO1992S002	2004 Rural		530,000	793,000	LITTLE CATTAIL CREEK	102
LARRILAND FARM	IRRIGATION	30,000	1,400,000	Irrigation	HO1992S004	2004 Rural		538,000	770,000	CATTAIL BRANCH	103
MCKENDREE ASSOCIATES,	GREENHOUSE & FIELD IRRIGATION	4,000	30,000	Irrigation	HO1992S008	2004 Rural		538,000	799,000	UNNAMED TRIB	105
STEDDING, WILLIAM, M.	GREEN MANOR TURF FARM	31,000	465,000	Irrigation	HO1992S009	2004 Rural		545,000	813,000	SOUTH BRANCH	106
DELPH, JOHN L.	LIVESTOCK WATERING	300	500	Irrigation	HO1992S011	2005 Rural		556,000	765,000	SOUTH BRANCH	108
WARREN H. BOYER. INC.,	IRRIGATION FROM LARGE POND OUT BACK	34,000	300,000	Irrigation	HO1992S102	2004 Rural		530,000	793,000	LITTLE CATTAIL CREEK	109
WARREN H. BOYER INC.	NURSERY IRRIGATION, STREAM POND	1,500	15,000	Irrigation	HO1992S202	2004 Rural		530,000	793,000	CATTAIL CREEK	110
RONALD BAIRE	NURSERY STOCK IRRIGATION	700	2,500	Irrigation	HO1993G002	2006 Rural		503,000	810,000	LOWER PELITIC SCHIST WISSAHICKON	111
VALLEY BROOK COMMUNITY CHURCH	CHURCH & SCHOOL	700	1,000	Potable	HO1993G004	2002 Rural		489,000	816,000	BALTIMORE GNEISS	112
WEST FRIENDSHIP CENTER LLC	HIGH'S STORE OF WEST FRIENDSHIP	200	400	Potable	HO1993G005	2005 Rural		536,000	813,000	LOWER PELITIC SCHIST WISSAHICKON	113

Owner (-)	Remarks (-)	Average Daily Flow Rate (gpd)	Maximum		Type of Use (-)	Water		Effective Date (Year)	Area (-)	Northing Coordinate (-)	Easting Coordinate (-)	Groundwater Aquifer (-)	GIS Identifier (-)
			Month Average Daily Flow Rate (gpd)			Appropriation Permit Number (-)							
ADVENTURE NURSERY	NURSERY IRRIGATION	15,400	23,100	Irrigation	HO1993G007	2005	Rural	542,000	791,000	WISSAHICKON FORMATION	114		
MT. ZION UNITED METHODIST CHURCH	MT. ZION UNITED METHODIST CHURCH	3,600	7,000	Potable	HO1993G018	2003	Rural	486,000	816,000	BALTIMORE GNEISS	115		
LEA BAIRE	NURSERY STOCK IRRIGATION	3,800	9,000	Irrigation	HO1993S002	2006	Rural	511,000	815,000	MIDDLE PATUXENT RIVER	116		
KRATZ, CHARLES, E.	SHRUBS AND GRASSES IRRIGATION	1,200	3,000	Irrigation	HO1993S014	1993	Rural	528,000	808,000	MIDDLE PATUXENT RIVER	118		
DOWD, TIMOTHY,	TENNIS CLUB	3,000	9,000	Potable	HO1994G009	2007	Rural	539,000	785,000	WISSAHICKON FORMATION	120		
J.R. ENTERPRISES, LLP	INWOOD VILLAGE SHOPPING CENTER	5,000	7,500	Potable	HO1995G005	2010	Rural	535,000	794,000	BOULDER GNEISS WISSAHICKON FORM.	122		
TREE CENTER, INC.	LABOR CAMP KIMBERTHY TREE, TURF FARM	100	400	Potable	HO1995G006	1995	Rural	546,000	782,000	WISSAHICKON FORMATION	123		
ROMAN CATHOLIC ARCHBISHOP	CHURCH	1,300	2,200	Potable	HO1995G009	2007	Rural	478,000	826,000	LOWER PELITIC SCHIST WISSAHICKON	124		
MANNARELLI, SR., MARIO, F.	33-LOT SBDN	7,000	11,700	Potable	HO1995G020	2001	Rural	523,000	786,000	BOULDER GNEISS WISSAHICKON FORM.	125		
TARO INVESTMENT CORPORATION	TARO INVESTMENT CORPORATION	500	800	Potable	HO1996G011	2008	Rural	512,000	817,000	COCKEYSVILLE MARBLE	126		
HOWARD COUNTY DPW	CARRS MILL LANDFILL	90,000	144,000	Commercial	HO1997G004	2010	Rural	541,000	785,000	WISSAHICKON FORMATION	128		
SAPLING RIDGE LLC	107 LOT SBDN	22,900	38,200	Potable	HO1997G013	1999	Rural	513,000	795,000	BOULDER GNEISS WISSAHICKON FORM.	129		
THE VILLAS AT CATTAIL CREEK, LLC	VILLA AT CATTAIL CREEK	14,000	19,600	Potable	HO1997G021	2007	Rural	526,000	788,000	SYKESVILLE FORMATION	131		
STATE HIGHWAY ADMIN	STATE HIGHWAY SHOP	700	1,000	Potable	HO1997G024	1997	Rural	516,000	806,000	LOWER PELITIC SCHIST WISSAHICKON	132		
RUSSELL DEVELOPMENT, L.L.C.	GAITHER OVERLOOK - 74 LOTS	15,700	26,200	Potable	HO1997G026	2000	Rural	514,000	830,000	BALTIMORE GNEISS	133		
BRANTLY DEVELOPMENT GROUP, INC.	BRANTWOOD 122-LOT SUBD.	25,900	43,200	Potable	HO1998G003	1999	Rural	528,000	828,000	LOWER PELITIC SCHIST WISSAHICKON	135		
JOHN FRANK, DEPUTY FIRE CHIEF	FIRE & RESCUE TRAINING	500	12,000	Potable	HO1998G005	1998	Rural	541,000	798,000	BOULDER GNEISS WISSAHICKON FORM.	136		
GLENWOOD BAPTIST CHURCH	GLENWOOD BAPTIST CHURCH	100	300	Potable	HO1998G009	1998	Rural	521,000	787,000	BOULDER GNEISS WISSAHICKON FORM.	137		
LYNNGATE PROPERTIES, LLC	TERMINAL TIRES, INC.	300	500	Potable	HO1998G010	2010	Rural	522,000	803,000	LOWER PELITIC SCHIST WISSAHICKON	138		
HOODS MILL CORPORATION	51 LOT SBDN	10,800	18,100	Potable	HO1998G011	1999	Rural	544,000	797,000	BOULDER GNEISS WISSAHICKON FORM.	139		
HOWARD COUNTY DPW	WELL FOR GLENWOOD FIRE STATION	3,400	6,400	Potable	HO1998G013	2010	Rural	536,000	791,000	BOULDER GNEISS WISSAHICKON FORM.	140		
CHAU MINH DO, ,	IRRIGATION-GROW SPROUTS	200	500	Irrigation	HO1999G001	1999	Rural	552,000	777,000	WISSAHICKON FORMATION	141		
HAILEY DEVELOPMENT, L.C.	30 WELLS	6,600	11,000	Potable	HO1999G006	1999	Rural	526,000	803,000	BOULDER GNEISS WISSAHICKON FORM.	143		
NICHOLS, MARSHALL, W.		6,600	11,000	Potable	HO1999G013	1999	Rural	532,000	773,000	WISSAHICKON FORMATION	144		
ST. ANDREWS EPISCOPAL CH	ST ANDREWS EPISCOPAL CHURCH	500	1,500	Potable	HO1999G014	2000	Rural	532,000	792,000	BOULDER GNEISS WISSAHICKON FORM.	145		
C.C.O. LLC, ,	SINGLE FAMILY SUBDIVISION	3,000	5,000	Potable	HO1999G015	1999	Rural	524,000	791,000	BOULDER GNEISS WISSAHICKON FORM.	146		
UNITED STATES POSTAL SERVICE	UNITED STATES POST OFFICE - HIGHLAND	100	300	Potable	HO1999G017	1999	Rural	491,000	811,000	BALTIMORE GNEISS	147		
CUBBAGE, LLC, ,	RESIDENTIAL SUBDIVISION	5,600	9,300	Potable	HO1999G018	1999	Rural	522,000	794,000	BOULDER GNEISS WISSAHICKON FORM.	148		
RLO CONTRACTORS INC., ,		500	40,000	Potable	HO1999S004	1999	Rural	510,000	803,000	CHESAPEAKE BAY	149		
SCRIVNER, J., THOMAS	SINGLE FAMILY SUBDIVISION	5,300	8,900	Potable	HO2000G001	2000	Rural	521,000	795,000	BOULDER GNEISS WISSAHICKON FORM.	152		
VERTEX, INC.	RESTRICTED SUBDIVISION	2,800	4,600	Potable	HO2000G003	2000	Rural	529,000	801,000	BOULDER GNEISS WISSAHICKON FORM.	154		
BIG BRANCH, LLC	HOMEBuilder TOLL BROTHERS	100	200	Potable	HO2000G004	2000	Rural	514,000	798,000	BOULDER GNEISS WISSAHICKON FORM.	155		
REUWER, JR., DONALD, R.	FARM	7,800	177,500	Potable	HO2000G006	2000	Rural	520,000	782,000	BOULDER GNEISS WISSAHICKON FORM.	156		
GRODIN, MICHAEL, A.	MICHAEL A. GRODIN	800	3,000	Potable	HO2000G007	2000	Rural	528,000	780,000	BOULDER GNEISS WISSAHICKON FORM.	157		
FLOYD LANE, LLC	48 LOTS BUCKSKIN RIDGE	9,999	16,700	Potable	HO2000G011	2001	Rural	518,000	807,000	LOWER PELITIC SCHIST WISSAHICKON	159		
SDC GROUP, INC.	SDC GROUP, INC.	5,100	8,500	Potable	HO2000G013	2000	Rural	528,000	786,000	BOULDER GNEISS WISSAHICKON FORM.	161		
DEMASTUS, GLENN	VEGET. GARDEN & POOL	400	2,500	Potable	HO2000S005	2000	Rural	549,000	780,000	CATTAIL CREEK	162		
FOREST RECYCLING PROJECT INC.	FOREST RECYCLING PROJECT	7,000	20,000	Commercial	HO2000S010	2000	Rural	511,000	813,000	UNNAMED TRIB	163		
CATTAIL CREEK COUNTRY CLUB, INC.	CATTAIL CREEK GC - SWM POND	15,000	288,000	Commercial	HO2000S014	2001	Rural	525,000	786,000	LITTLE CATTAIL CREEK	164		
IAQUINTA, LOU	34-L FOX CREEK SUBD	7,300	12,100	Potable	HO2001G001	2001	Rural	534,000	818,000	LOWER PELITIC SCHIST WISSAHICKON	165		
3881 TEN OAKS MANAGEMENT, LLC,	COMERCIAL & RETAIL CENTER	2,500	3,800	Potable	HO2001G004	2005	Rural	522,000	804,000	LOWER PELITIC SCHIST WISSAHICKON	166		
NORTHRIDGE DEVELOPMENT, LLC	NORTHRIDGE DEVELOPMENT	3,400	5,700	Potable	HO2001G005	2001	Rural	530,000	803,000	METAGRAYWACKE WISSAHICKON FORM.	167		
SANBORN, JAMES, M.	KOANDAH GARDENS ESTATE	2,800	4,700	Potable	HO2001G006	2001	Rural	492,000	812,000	BALTIMORE GNEISS	168		
HOWARD COUNTY PUBLIC SCHOOLS	FOLLY QUARTER MIDDLE SCHOOL	5,000	8,000	Potable	HO2001G007	2009	Rural	522,000	805,000	LOWER PELITIC SCHIST WISSAHICKON	169		
GLENWOOD, LLC	GLENWOOD, LLC	3,000	4,000	Potable	HO2001G009	2001	Rural	535,000	794,000	WISSAHICKON FORMATION	170		
HAILEY DEVELOPMENT	RESIDENTIAL SUBDIVISION	2,600	4,500	Potable	HO2001G011	2001	Rural	531,000	812,000	LOWER PELITIC SCHIST WISSAHICKON	171		
MCCANN, ELIZABETH	17 LOT SBDN	3,700	6,100	Potable	HO2002G001	2002	Rural	546,000	793,000	WISSAHICKON FORMATION	172		

Owner (-)	Remarks (-)	Average Daily	Maximum	Type of Use (-)	Water	Effective	Area	Northing	Easting	Groundwater Aquifer (-)	GIS Identifier (-)
		Flow Rate (gpd)	Month Average Daily Flow Rate (gpd)		Appropriation Permit Number (-)						
HARRISON, CLIFTON AND BETTY	TWIN PINES	2,800	4,700	Potable	HO2002G002	2002 Rural		528,000	809,000	ULTRAMAFIC ROCKS	173
OWINGS, HARWOOD AND ALMA GAYE	OWINGS LOT #3	2,400	3,900	Potable	HO2002G003	2002 Rural		491,000	809,000	BALTIMORE GNEISS	174
CHANYASULKIT, JOHN & ANNA	CHLAYASLILKIT	2,000	3,000	Potable	HO2002G004	2002 Rural		550,000	748,000	IJAMSVILLE FORM.-MARBURG SCHIST	175
GST TRUST & SISTER'S TRUST	RESIDENTIAL	9,600	16,000	Potable	HO2002G005	2002 Rural		528,000	798,000	WISSAHICKON FORMATION	176
THOMPSON, DALE	HOME BUILDER/DEVELOPER	1,700	2,900	Potable	HO2002G007	2002 Rural		491,000	813,000	BALTIMORE GNEISS	177
DAR AL-TAQWA, INC.	RELIGIOUS FACILITY	500	800	Potable	HO2002G008	2002 Rural		511,000	832,000	BALTIMORE GNEISS	178
PULTE HOME CORPORATION	PADDOCKS EAST 22 LOTS	4,700	7,800	Potable	HO2002G009	2004 Rural		525,000	806,000	ULTRAMAFIC ROCKS	179
RIDGE VIEW, LLC	RIDGE VIEW LLC	3,900	6,400	Potable	HO2002G010	2002 Rural		546,000	757,000	WISSAHICKON FORMATION	180
TEMPLE ISAIAH	TEMPLE ISAIAH	3,000	7,000	Potable	HO2002G011	2002 Rural		485,000	818,000	BALTIMORE GNEISS	181
WOODMONT ACADEMY, INC.	WOODMONT ACADEMY	8,300	11,000	Potable	HO2002G012	2002 Rural		541,000	799,000	BOULDER GNEISS WISSAHICKON FORM.	182
BUICE, MR. ROBERT	MR. ROBERT BUICE	2,800	4,700	Potable	HO2002G014	2002 Rural		517,000	786,000	BOULDER GNEISS WISSAHICKON FORM.	184
ST. JAMES UNITED METHODIST	CHURCH AND DAY SCHOOL	800	1,200	Potable	HO2002G015	2005 Rural		541,000	816,000	LOWER PELITIC SCHIST WISSAHICKON	185
SEWELL, ARNOLD	RESIDENTIAL SUBDIVISION	3,900	6,400	Potable	HO2002G016	2002 Rural		542,000	810,000	BOULDER GNEISS WISSAHICKON FORM.	186
IGLEHART, ET. AL., MILTON	RESIDENTIAL SUBDIVISION	3,000	5,000	Potable	HO2002G017	2002 Rural		492,000	820,000	BALTIMORE GNEISS	187
EASTER, JIM	PRIVATE RESIDENCE	200	300	Potable	HO2002S006	2002 Rural		492,000	814,000	UNNAMED TRIB	188
CASTLEBERRY AT TEN OAKS, LLC	CASTLEBERRY AT TEN OAKS, LLC	9,800	16,300	Potable	HO2003G001	2003 Rural		518,000	803,000	LOWER PELITIC SCHIST WISSAHICKON	190
CALVARY LUTHERAN CHURCH	CHURCH	300	500	Potable	HO2003G002	2003 Rural		552,000	780,000	WISSAHICKON FORMATION	191
TOLL BROTHERS, INC.	RESIDENTIAL SUBDIVISION	5,100	8,500	Potable	HO2003G003	2003 Rural		486,000	821,000	LOWER PELITIC SCHIST WISSAHICKON	192
SMITH, TOM	GREENHOUSE	800	2,500	Irrigation	HO2003G004	2003 Rural		536,000	802,000	BOULDER GNEISS WISSAHICKON FORM.	193
PRESERVE AT WAVERLY GLEN, LLC	PRESERVE AT WAVERLY GLEN, LLC	5,100	8,500	Potable	HO2003G005	2003 Rural		542,000	832,000	BALTIMORE GNEISS	194
TOLL MD II LIMITED PARTNERSHIP,	90 LOT SBDN	19,100	31,900	Potable	HO2003G006	2004 Rural		510,000	825,000	LOWER PELITIC SCHIST WISSAHICKON	195
RADUE, PETER	DAMASCUS EQUINE ASSOCIATES	300	500	Potable	HO2003G007	2003 Rural		542,000	757,000	IJAMSVILLE FORM.-MARBURG SCHIST	196
RAPFALIDES, MARIA	W. FRIENDSHIP SHOPPING CENTER	4,300	6,100	Potable	HO2003G008	2003 Rural		535,000	813,000	LOWER PELITIC SCHIST WISSAHICKON	197
GLYNN, JAMES & CAROLE	CONSIGNMENT SHOP	100	200	Potable	HO2003G010	2003 Rural		491,000	812,000	BALTIMORE GNEISS	198
TRINITY QUALITY HOMES, INC.	RESIDENTIAL-TRINITY QUALITY HOMES	4,500	7,500	Potable	HO2003G011	2003 Rural		543,000	776,000	WISSAHICKON FORMATION	199
HOWARD COUNTY PUBLIC SCHOOLS	WESTERN ELEM SCHOOL - TEN OAKS RD	2,100	7,700	Potable	HO2003G015	2004 Rural		513,000	804,000	METAGRAYWACKE WISSAHICKON FORM.	201
DORSEY MILL, LLC	RESIDENTIAL	5,500	9,200	Potable	HO2003G016	2003 Rural		520,000	795,000	BOULDER GNEISS WISSAHICKON FORM.	202
GOOD HOPE REFORMED PRESBYTERIAN		300	400	Potable	HO2004G001	2004 Rural		483,000	818,000	BALTIMORE GNEISS	203
ST. PAUL'S EPISCOPAL CHURCH	EPISCOPAL CHURCH	100	200	Potable	HO2004G002	2004 Rural		552,000	774,000	WISSAHICKON FORMATION	204
BORNEMANN, DVM, VALERIE	GLENELG ANIMAL HOSPITAL	600	700	Potable	HO2004G003	2004 Rural		542,000	793,000	WISSAHICKON FORMATION	205
TOLL BROTHERS, INC.	27 RESIDENTIAL SINGLE FAMILY	5,800	9,700	Potable	HO2004G005	2004 Rural		519,000	795,000	BOULDER GNEISS WISSAHICKON FORM.	206
HOMEWOOD LLC	HOMEWOOD, LLC - ADDING ONE LOT	17,200	28,300	Potable	HO2004G007	2007 Rural		516,000	825,000	LOWER PELITIC SCHIST WISSAHICKON	207
MACBETH FARM, LLC	RESIDENTIAL REAL ESTATE DEVEL	7,700	13,000	Potable	HO2004G008	2004 Rural		495,000	816,000	BALTIMORE GNEISS	208
HOWARD COUNTY DPW	GLENWOOD COMMUNITY CENTER	2,400	4,800	Potable	HO2004G010	2005 Rural		536,000	791,000	WISSAHICKON FORMATION	209
TRIADELPHIA FARM, LLC	SUBDIVISION	6,000	11,400	Potable	HO2004G011	2004 Rural		522,000	790,000	BOULDER GNEISS WISSAHICKON FORM.	210
LIME KILN VALLEY, LLC	SUBDIVISION	7,800	13,000	Potable	HO2004G013	2006 Rural		480,000	810,000	LOWER PELITIC SCHIST WISSAHICKON	211
MMGMB, LLC	GENERAL OFFICE BUILDING	1,400	2,000	Potable	HO2004G014	2004 Rural		531,000	790,000	BOULDER GNEISS WISSAHICKON FORM.	212
MUSGROVE FARM, LLC	RESIDENTIAL SUBDIVISION	6,600	11,130	Potable	HO2005G002	2005 Rural		524,000	798,000	BOULDER GNEISS WISSAHICKON FORM.	213
HIGHLAND CROSSING, LLC	HIGHLAND CROSSING, LLC	2,000	2,500	Potable	HO2005G005	2005 Rural		490,000	812,000	BALTIMORE GNEISS	214
HERITAGE LAND DEVELOPMENT	WALNUT GROVE	19,200	32,100	Potable	HO2005G006	2006 Rural		508,000	817,000	COCKEYSVILLE MARBLE	215
WILLIAMSBURG GROUP L.L.C.	RESIDENTIAL SUBDIV	4,300	7,000	Potable	HO2005G007	2006 Rural		512,000	816,000	LOWER PELITIC SCHIST WISSAHICKON	216
SHALEHEARTH, L.C.	SADLEBROOK FARM 13-LOT SBDN	2,800	4,700	Potable	HO2005G009	2006 Rural		542,000	835,000	BALTIMORE GNEISS	217
HIGHLAND DEVELOPMENT CORP.	RESIDENTIAL SUBDIVISION 23 LOTS	4,800	7,300	Potable	HO2006G002	2006 Rural		500,000	800,000	LOWER PELITIC SCHIST WISSAHICKON	219
D.R. HORTON, INC.	TURNBURY GROVE 33-LOT SBDN	7,000	11,700	Potable	HO2006G003	2006 Rural		499,000	814,000	BALTIMORE GNEISS	220
TOLL BROTHERS, INC.	EDGEWOOD FARM SUBDIVISION - 60 LOTS	12,700	21,200	Potable	HO2006G004	2007 Rural		519,000	793,000	BOULDER GNEISS WISSAHICKON FORM.	221
MANNARELLI & SONS	MANNARELLI & SONS	2,400	4,000	Potable	HO2006G005	2006 Rural		555,000	783,000	WISSAHICKON FORMATION	222
CLOVERFIELD/PFEFFERKORN, LLC	CLOVERFIELD/PFEFFERKORN, LLC	4,700	7,800	Potable	HO2006G006	2006 Rural		535,000	803,000	BOULDER GNEISS WISSAHICKON FORM.	223

Owner (-)	Remarks (-)	Average Daily	Maximum	Type of Use (-)	Water	Effective Date (Year)	Area (-)	Northing Coordinate (-)	Easting Coordinate (-)	Groundwater Aquifer (-)	GIS Identifier (-)
		Flow Rate (gpd)	Month Average Daily Flow Rate (gpd)		Appropriation Permit Number (-)						
MANNARELLI & SONS	MANNARELLI & SONS	3,200	5,300	Potable	HO2006G007	2006 Rural		555,000	783,000	WISSAHICKON FORMATION	224
WARFIELD, JR., MR & MRS K.	69 LOT WARFIELDS SUBDIVISION	15,000	22,000	Potable	HO2006G009	2006 Rural		516,000	796,000	BOULDER GNEISS WISSAHICKON FORM.	225
LDG INCORPORATED	RESIDENTIAL SUBDIVISION	4,900	8,200	Potable	HO2006G011	2006 Rural		540,000	812,000	LOWER PELITIC SCHIST WISSAHICKON	226
HAILEY DEVELOPMENT LC	HAILEY DEVELOPMENT, LC	2,750	3,300	Potable	HO2006G012	2006 Rural		528,000	811,000	LOWER PELITIC SCHIST WISSAHICKON	227
LEE, BRUCE	16 LOT SBDN	3,400	5,700	Potable	HO2006G014	2006 Rural		552,000	780,000	WISSAHICKON FORMATION	228
FULTON RIDGE, LLC	RESIDENTIAL SUBDIVISION	3,000	5,000	Potable	HO2006G015	2006 Rural		485,000	819,000	LOWER PELITIC SCHIST WISSAHICKON	229
DAVIS BRANCH ESTATES LLC	MYRTUE PROPERTES	6,600	11,100	Potable	HO2006G018	2006 Rural		542,000	835,000	BALTIMORE GNEISS	230
HERITAGE LAND DEVELOPMENT	160-L WALNUT CREEK SUBD	34,000	56,000	Potable	HO2006G020	2009 Rural		510,000	815,000	BALTIMORE GNEISS	231
JEANNE C. HODDINOTT	ENCLAVE AT TIERNEY FARM RES SUBD	8,500	14,100	Potable	HO2006G021	2010 Rural		496,000	817,000	BALTIMORE GNEISS	232
RIDGE VIEW LLC	SINGLE FAMILY HOME SUBDIVISION	3,800	6,400	Potable	HO2007G001	2007 Rural		546,000	757,000	IJAMSVILLE FORM.-MARBURG SCHIST	233
GRAYSON DEVELOPMENT CO	GRAYSON DEVELOPMENT CO.	9,700	16,200	Potable	HO2007G002	2007 Rural		530,000	787,000	BOULDER GNEISS WISSAHICKON FORM.	234
SPRING MILL LLC	15-L CLOVERFIELD SECTION II RES SUBD	3,200	5,300	Potable	HO2007G003	2010 Rural		536,000	802,000	BOULDER GNEISS WISSAHICKON FORM.	235
GREEN, KATHLEEN	CROSSROADS PUB - PDWIS# 113-1026	400	600	Potable	HO2007G004	2007 Rural		512,000	804,000	LOWER PELITIC SCHIST WISSAHICKON	236
ELM STREET DEVELOPMENT, INC.	14-L CHELSEA KNOLLS RES SUBD	3,000	5,000	Potable	HO2007G005	2009 Rural		540,000	757,000	IJAMSVILLE FORM.-MARBURG SCHIST	237
QUARTZ HILL, LLC	QUARTZ HILL RESIDENTIAL SUBDIV	2,600	4,500	Potable	HO2007G011	2007 Rural		550,000	796,000	BOULDER GNEISS WISSAHICKON FORM.	238
HOMEWOOD LLC	HOMEWOOD, LLC - RIVERWOOD SUBDIV	300	500	Potable	HO2007G012	2007 Rural		516,000	825,000	LOWER PELITIC SCHIST WISSAHICKON	239
SKIRVEN ENTERPRISES, INC.	29-LOT THE LEGACY RES SUBD	6,400	10,000	Potable	HO2007G013	2008 Rural		522,000	774,000	WISSAHICKON FORMATION	240
GREENFIELD HOMES, INC.	14-LOT WILLOW POND RESIDENTIAL SUBD	3,000	5,000	Potable	HO2008G001	2009 Rural		495,000	814,000	BALTIMORE GNEISS	241
HERITAGE LAND DEVELOPMENT	MERIWETHER-SECT.2, PHASE 1&2	9,700	16,200	Potable	HO2008G010	2009 Rural		519,000	791,000	BOULDER GNEISS WISSAHICKON FORM.	243
ROBERT M. HANEY	NURSERY IRRIGATION	46,000	169,600	Irrigation	HO2008S002	2009 Rural		548,000	781,000	CATTAIL BRANCH	244
THOMAS, BENNETT AND HUNTER	DUST CONTROL, PATAPSCO WATERSHED	1,000	5,000	Commercial	HO2008S006	2008 Rural		550,000	834,000	PATAPSCO RIVER	245
THOMAS, BENNETT AND HUNTER	DUST CONTROL, PATAPSCO WATERSHED	1,000	5,000	Commercial	HO2008S007	2008 Rural		540,000	754,000	PATUXENT RIVER	246
THE BRANTLEY GROUP	TERRAPIN CROSSING SUBDIVISION	9,900	16,600	Potable	HO2009G001	2009 Rural		532,000	811,000	LOWER PELITIC SCHIST WISSAHICKON	249
JOHN R. CLIME	JOHN R. CLIME-NURSERY	3,000	12,000	Commercial	HO2009G002	2009 Rural		539,000	782,800	BALTO. GABBRO COMPLEX	250
VLADIMIR BLYUKHER	GWHP- STANDING COLUMN WELL	6,000	9,000	Potable	HO2010G001	2010 Rural		513,000	830,000	LOWER PELITIC SCHIST WISSAHICKON	251
		1,462,849									

Table 3.1: Little Patuxent Water Reclamation Plant (LP WRP) Final Effluent Flow Rate

Monthly Data																				
Year:	1999	2000	2001	2002	2003	2004	2005	2006	2007	2008	2009	2010	2011	2012	2013	2014	2015	2016	2017	
Month (-)	Average Daily Effluent Flow Rate (mgd)	Average Daily Effluent Flow Rate (mgd)	Average Daily Effluent Flow Rate (mgd)	Average Daily Effluent Flow Rate (mgd)	Average Daily Effluent Flow Rate (mgd)	Average Daily Effluent Flow Rate (mgd)	Average Daily Effluent Flow Rate (mgd)	Average Daily Effluent Flow Rate (mgd)	Average Daily Effluent Flow Rate (mgd)	Average Daily Effluent Flow Rate (mgd)	Average Daily Effluent Flow Rate (mgd)	Average Daily Effluent Flow Rate (mgd)	Average Daily Effluent Flow Rate (mgd)	Average Daily Effluent Flow Rate (mgd)	Average Daily Effluent Flow Rate (mgd)	Average Daily Effluent Flow Rate (mgd)	Average Daily Effluent Flow Rate (mgd)	Average Daily Effluent Flow Rate (mgd)	Average Daily Effluent Flow Rate (mgd)	Average Daily Effluent Flow Rate (mgd)
January	17.30	17.60	17.60	16.40	17.30	20.40	19.40	20.30	20.70	15.50	16.10	18.15	15.00	17.80	17.20					17.78
February	16.70	18.70	17.90	16.30	17.60	21.60	19.00	20.80	19.80	16.80	15.70	18.96	16.40	17.20	17.50					18.06
March	18.10	19.00	18.70	17.70	21.30	20.00	20.20	19.10	21.90	17.20	15.90	22.45	17.60	16.90	18.50					18.97
April	17.70	19.60	18.60	17.60	21.40	21.40	21.30	18.80	21.20	17.40	17.30	18.84	17.20	16.30	17.70					18.82
May	17.00	17.90	18.00	17.80	21.40	20.00	19.10	18.50	19.80	19.70	18.20	17.38	16.70	16.60						18.43
June	16.60	17.80	18.60	17.00	23.90	19.40	18.40	19.30	18.80	17.80	19.00	16.59	15.50	16.90						18.26
July	16.20	17.10	16.60	16.80	20.00	18.20	18.40	18.50	18.00	16.70	15.70	15.20	14.80	17.90						17.15
August	15.40	17.30	15.50	16.50	17.90	18.50	17.80	16.80	17.50	16.10	15.30	15.30	15.60	18.50						16.71
September	18.70	17.80	13.60	16.70	18.50	17.70	16.80	17.60	17.30	16.60	15.00	14.50	18.90	18.00						16.98
October	17.80	16.90	15.30	17.50	19.70	17.60	19.00	18.90	17.10	16.80	15.60	15.30	17.20	19.40						17.44
November	17.00	15.90	15.80	18.20	21.60	18.00	18.00	20.80	16.40	17.20	16.50	15.20	16.90	19.00						17.61
December	17.70	17.30	17.00	16.60	22.80	18.90	19.10	19.70	16.00	16.50	18.80	15.20	18.80	18.90						18.09
Calendar Average Annual Effluent Flow Rate (mgd)	17.18	17.74	16.93	17.09	20.28	19.31	18.88	19.09	18.71	17.03	16.59	16.92	16.72	17.78	17.73	#DIV/0!	#DIV/0!	#DIV/0!	#DIV/0!	17.86
Fiscal Average Annual Effluent Flow Rate (mgd)		17.78	17.64	16.38	18.77	20.28	18.86	18.83	19.54	17.23	16.84	17.44	15.76	16.99	18.26	#DIV/0!	#DIV/0!	#DIV/0!	#DIV/0!	
Total Calendar Year Effluent Flow (MG)	6,271.92	6,475.71	6,180.67	6,238.46	7,403.42	7,047.54	6,889.38	6,968.46	6,828.54	6,214.13	6,055.96	6,176.71	6,101.58	6,490.92	6,469.63	#DIV/0!	#DIV/0!	#DIV/0!	#DIV/0!	
Seasonal Data																				
Month (-)	Average Daily Effluent Flow Rate (mgd)	Average Daily Effluent Flow Rate (mgd)	Average Daily Effluent Flow Rate (mgd)	Average Daily Effluent Flow Rate (mgd)	Average Daily Effluent Flow Rate (mgd)	Average Daily Effluent Flow Rate (mgd)	Average Daily Effluent Flow Rate (mgd)	Average Daily Effluent Flow Rate (mgd)	Average Daily Effluent Flow Rate (mgd)	Average Daily Effluent Flow Rate (mgd)	Average Daily Effluent Flow Rate (mgd)	Average Daily Effluent Flow Rate (mgd)	Average Daily Effluent Flow Rate (mgd)	Average Daily Effluent Flow Rate (mgd)	Average Daily Effluent Flow Rate (mgd)	Average Daily Effluent Flow Rate (mgd)	Average Daily Effluent Flow Rate (mgd)	Average Daily Effluent Flow Rate (mgd)	Average Daily Effluent Flow Rate (mgd)	Average Daily Effluent Flow Rate (mgd)
Winter (January - March)	17.37	18.43	18.07	16.80	18.73	20.67	19.53	20.07	20.80	16.50	15.90	19.85	16.33	17.30	17.73					18.27
Spring (April - June)	17.10	18.43	18.40	17.47	22.23	20.27	19.60	18.87	19.93	18.30	18.17	17.60	16.47	16.60	17.70					18.48
Summer (July - September)	16.77	17.40	15.23	16.67	18.80	18.13	17.67	17.63	17.60	16.47	15.33	15.00	16.43	18.13						16.95
Autumn (September - December)	17.50	16.70	16.03	17.43	21.37	18.17	18.70	19.80	16.50	16.83	16.97	15.23	17.63	19.10						17.71
Calendar Average Annual Effluent Flow Rate (mgd)	17.18	17.74	16.93	17.09	20.28	19.31	18.88	19.09	18.71	17.03	16.59	16.92	16.72	17.78	17.72	#DIV/0!	#DIV/0!	#DIV/0!	#DIV/0!	17.85
Fiscal Average Annual Effluent Flow Rate (mgd)		17.94	17.10	16.74	19.30	20.11	18.74	18.82	19.53	16.94	16.56	17.36	16.12	17.42	18.18	#DIV/0!	#DIV/0!	#DIV/0!	#DIV/0!	
Total Calendar Year Effluent Flow (MG)	6,271.92	6,475.71	6,180.67	6,238.46	7,403.42	7,047.54	6,889.38	6,968.46	6,828.54	6,214.13	6,055.96	6,176.71	6,101.58	6,490.92	6,466.58	#DIV/0!	#DIV/0!	#DIV/0!	#DIV/0!	

Table 3.2: Reclaimed Water Distribution Mains

	Length of Reclaimed Water Main <u>(LF)</u>	Reclaimed Water Main Diameter <u>(in)</u>	Construction Contract <u>(-)</u>	Year <u>(-)</u>
Reclaimed Water and Sewer Pipelines (Dreyer's Ice Cream) Fort Meade	6,585.00	12	4447	2007
Laurel Sand and Gravel Inc.				Under Construction
Total:	6,585.00 LF			

Table 3.3: Reclaimed Water Pumping Stations

Reclaimed Water Pumping Station (-)	Location of Reclaimed Water Pumping Station (-)	ADC Map Coordinates (-)	Reclaimed Water Pumping Capacity (mgd)	Pressure Zone (Lower / Upper) (-)	Construction Contract (-)	Year (-)
Reclaimed Water Pumping Station	Little Patuxent Water Reclamation Plant (LP WRP)		4.125 at 365 ft Design Point for Two Pumps in Parallel		4565	2008
Fort Meade Reclaimed Water Pumping Station						Under Construction
Total:			4.125 million gallons			

Table 3.4: Reclaimed Water Storage Tanks

In-System Storage

Reclaimed Water Storage Tank (-)	Location of Reclaimed Water Storage Tank (-)	ADC Map Coordinates (-)	Reclaimed Water Storage Volume (mil gal)	Overflow Elevation (ft)	Construction Contract (-)	Year (-)
Little Patuxent Water Reclamation Plant (LP WRP)			0.000		N/A	
Guilford Reclaimed Water Storage Tank			3.000		4565	2008
Total:			3.000 million gallons			

Out-of-System Storage

Out-of-System Storage (-)	Location of Reclaimed Water Storage Tank (-)	ADC Map Coordinates (-)	Reclaimed Water Storage Volume (mil gal)	Overflow Elevation (ft)	Construction Contract (-)	Year (-)
Dreyer's Grand Ice Cream, Inc.			0.000		N/A	
Laurel Sand and Gravel Inc.			0.000		N/A	
Fort Meade			0.000		N/A	
Total:			0.000 million gallons			

Total Reclaimed Water Storage:

3.000 million gallons

Table 5.1: Reclaimed Water Balance

	Supply	Demand	Eliminated	Remainder	Discharged				Unaccounted	Outfall
					Flow Discharged to LP WRP Sanitary Sewer (mgd)	Flow Discharged to Patapsco WWTP (mgd)	Flow Discharged to Fort Meade WWTP (mgd)	Flow Discharged to NPDES Permitted Outfall (mgd)		
	LP WRP Average Daily Effluent Flow Rate (mgd)	Reclaimed Water Average Daily Demand Flow Rate (mgd)	Flow Lost to Consumptive or Evaporative Use (mgd)	Used or Excess Reclaimed Water (mgd)	Flow Discharged to LP WRP Sanitary Sewer (mgd)	Flow Discharged to Patapsco WWTP (mgd)	Flow Discharged to Fort Meade WWTP (mgd)	Flow Discharged to NPDES Permitted Outfall (mgd)	Remainder / Unaccounted Flow (mgd)	LP WRP Outfall Discharge (mgd)
Winter (January - March)	18.272444	5.000000	0.000000	5.000000	0.000000	0.000000	5.000000	0.000000	0.000000	13.272444
Spring (April - June)	18.475778	5.000000	0.000000	5.000000	0.000000	0.000000	5.000000	0.000000	0.000000	13.475778
Summer (July - September)	16.947619	5.000000	0.000000	5.000000	0.000000	0.000000	5.000000	0.000000	0.000000	11.947619
Autumn (October - December)	17.711905	5.000000	0.000000	5.000000	0.000000	0.000000	5.000000	0.000000	0.000000	12.711905
Average:	17.851937	5.000000	0.000000	5.000000	0.000000	0.000000	5.000000	0.000000	0.000000	12.851937

Table 5.2: Reclaimed Water Anticipated Demand by Existing & Pending Customers

Season (-)	Fort Meade (mgd)	Dreyer's Grand Ice Cream, Inc. (mgd)	Laurel Sand and Gravel Inc. (mgd)	0 (mgd)	0 (mgd)	0 (mgd)	0 (mgd)	0 (mgd)	0 (mgd)	0 (mgd)	0 (mgd)	0 (mgd)	Total (mgd)
Winter (January - March)	5.000000	0.000000	0.000000	0.000000	0.000000	0.000000	0.000000	0.000000	0.000000	0.000000	0.000000	0.000000	5.000000
Spring (April - June)	5.000000	0.000000	0.000000	0.000000	0.000000	0.000000	0.000000	0.000000	0.000000	0.000000	0.000000	0.000000	5.000000
Summer (July - September)	5.000000	0.000000	0.000000	0.000000	0.000000	0.000000	0.000000	0.000000	0.000000	0.000000	0.000000	0.000000	5.000000
Autumn (October - December)	5.000000	0.000000	0.000000	0.000000	0.000000	0.000000	0.000000	0.000000	0.000000	0.000000	0.000000	0.000000	5.000000
Average:	5.000000	0.000000	0.000000	0.000000	0.000000	0.000000	0.000000	0.000000	0.000000	0.000000	0.000000	0.000000	5.000000
Reuse Category:	COM	COM	IND	0	0	0	0	0	0	0	0	0	0
Minimum Reclaimed Water Quality Classification Required:	IV	IV	IV	0	0	0	0	0	0	0	0	0	0

Reuse Categories

IRW: Irrigation - Restricted Access with Wider Buffer Zone (Class I minimum)

IRN: Irrigation - Restricted Access with Narrower Buffer Zone (Class II minimum)

IUO: Irrigation - Unrestricted Access and Other Restricted Uses (Class III minimum)

ILO: Residential Lawn Irrigation / Other Unrestricted Access Water Reuses (Class IV minimum)

COM: Commercial (Class IV minimum)

IND: Industrial (Class IV minimum)

Source: MDE Guidelines for Use of Reclaimed Water, Draft 6-11-2012, Table 1 - Class of Reclaimed Water Suitable for Various Types of Water Reuses

Table 5.3: Reclaimed Water Demand by Reuse Category

Season (-)	Reuse Category						Total (mgd)
	IRW: Irrigation - Restricted Access with Wider Buffer Zone (Class I minimum) (mgd)	IRN: Irrigation - Restricted Access with Narrower Buffer Zone (Class II minimum) (mgd)	IUO: Irrigation - Unrestricted Access and Other Restricted Uses (Class III minimum) (mgd)	ILO: Residential Lawn Irrigation / Other Unrestricted Access Water Reuses (Class IV minimum) (mgd)	COM: Commercial (Class IV minimum) (mgd)	IND: Industrial (Class IV minimum) (mgd)	
Winter (January - March)	0.000000	0.000000	0.000000	0.000000	5.000000	0.000000	5.000000
Spring (April - June)	0.000000	0.000000	0.000000	0.000000	5.000000	0.000000	5.000000
Summer (July - September)	0.000000	0.000000	0.000000	0.000000	5.000000	0.000000	5.000000
Autumn (October - December)	0.000000	0.000000	0.000000	0.000000	5.000000	0.000000	5.000000
Average:	0.000000	0.000000	0.000000	0.000000	5.000000	0.000000	5.000000

Source: MDE Guidelines for Use of Reclaimed Water, Draft 6-11-2012, Table 1 - Class of Reclaimed Water Suitable for Various Types of Water Reuses

Table 1 – Class of Reclaimed Water Suitable for Various Types of Water Reuses

Reuse Category	Type of Reuse	Class ^e
Irrigation - Restricted Access ^a with Wider Buffer Zone ^b	(1)Irrigation for food crops commercially processed ^c , and (2) Irrigation for forested land, non-food crops and turf including fodder, fiber and seed crops; pasture for foraging livestock; sod farms; golf courses; ornamental nurseries; and silviculture	Class I, Class II, Class III, Class IV
Irrigation - Restricted Access ^a with Narrower Buffer Zone ^b	(1)Irrigation for food crops commercially processed ^c , and (2) Irrigation for forested land, non-food crops and turf including fodder, fiber and seed crops; pasture for foraging livestock; sod farms; golf courses; ornamental nurseries; and silviculture	Class II, Class III, Class IV
Irrigation - Unrestricted Access ^a and Other Restricted Uses	(1) Irrigation for parks, play grounds, school yards, cemeteries, golf courses; highway landscapings and other green open spaces where public access is not restricted; and (2) fire protection (excluding residential sprinkler system)	Class III, Class IV
Residential Lawn Irrigation/Other Unrestricted Access Water Reuses	(1)toilet and urinal flushing ^d , (2) residential lawn irrigation (3) dust control and soil compaction, (4) aesthetic fountains, ponds, and lagoons, (5) non-food crops, (6) food crops (no contact with edible portion of the unprocessed crops), and (7) other water reuse categories approved by the Department.	Class IV
Commercial	Reuse of reclaimed water for laundries, car washing, snow making, air conditioning and closed loop cooling, window washing and pressure cleaning, other water reuse categories approved by the Department.	Class IV ^f
Industrial	Reuse of reclaimed water for cooling water, washing aggregates and making concrete; parts washing and cleaning, equipment operations, and other manufacturing processes approved by the Department	Class IV ^f

- a) "Restricted access" means limited access by humans to areas where any water, including reclaimed water, not meeting the definition of potable water is used, resulting in minimal or no potential for human contact. Accessibility to such sites will be limited to authorized operators and personnel. "Unrestricted access" means unlimited or minimally limited access by humans to areas where any water, including reclaimed water, not meeting the definition of potable water is used, resulting in a high potential for human contact.
- b) For more information on buffers for Class IV reclaimed water refer to chapter 10, section I of this document. For more information on buffers for Class I through III reclaimed waters, refer to the buffer section of the Department's "Guidelines for Land Application/Reuse of Treated Municipal Wastewaters."
- c) "Food crops commercially processed" means food crops that, prior to sale to the public or others, have undergone chemical or physical processing sufficient to remove or destroy pathogens.
- d) Only applicable to commercial buildings; or condominiums managed by a property management company or other similar corporate entity acceptable to the Department.
- e) Please refer to MDE 'Guidelines for Land Application/Reuse of Treated Municipal Wastewaters' for Class I, Class II, and Class III reclaimed water quality limitations.
- f) Only applicable to commercial and industrial uses of reclaimed water involving human contact or other public health risks. Otherwise, the Department may allow lower quality water to be used on a case by case basis, per chapter 2, section C.

Appendix A: Form of Reclaimed Water Utility Customer Agreement

between

Howard County Department of Public Works

and

TABLE OF CONTENTS

1. **RECITALS**.....3

2. **DEFINITIONS**.....3

3. **DELIVERY OF RECLAIMED WATER**.....4

4. **USE OR APPLICATION OF RECLAIMED WATER**.....5

5. **CUSTOMER’S ON-SITE FACILITY MODIFICATIONS**.....5

6. **INSPECTION**.....6

7. **MONITORING AND REPORTING**.....6

8. **QUALITY OF RECLAIMED WATER**6

9. **RECLAIMED WATER SUPERVISOR**6

10. **OPERATIONAL REQUIREMENTS**7

11. **NOTIFICATION OF PUBLIC**.....8

12. **INDEMNITY**8

13. **ENFORCEMENT**9

14. **PRICE AND PAYMENT FOR USE OF RECLAIMED WATER**9

15. **RESALE OF RECLAIMED WATER**9

16. **COMPLIANCE WITH REGULATIONS**.....10

17. **TERM, RENEWAL, AND TERMINATION**10

18. **GENERAL CONDITIONS**11

19. **SIGNATURES**11

EXHIBIT A – APPLICATION FOR RECEIVING RECLAIMED WATER SERVICE

1. RECITALS

This **Reclaimed Water Utility Customer** Agreement (this "Agreement") is made and entered into this _____ day of _____, _____ by and between the Howard County, Maryland, a body corporate and politic ("County"), and _____, a _____, in good standing under the laws of Maryland ("Customer").

WHEREAS, Customer is a proposed Reclaimed Water customer of the County, and Customer desires to purchase Reclaimed Water for purposes where Potable Water quality is not required by County, State, or Federal Laws and Regulations; and

WHEREAS, the County owns and operates a treatment and delivery system which shall be capable of delivering Reclaimed Water to Customer; and

WHEREAS, [an existing public Reclaimed Water pipeline is located adjacent to Customer's property] [Customer desires to haul Reclaimed Water per all applicable regulations to Customer's property] [Customer desires to reimburse the County for the construction of a public Reclaimed Water pipeline to the Customer's property]; and

WHEREAS, Customer intends to construct, operate and maintain a private Reclaimed Water system in Customer's Facility; and

WHEREAS, Customer intends to use Reclaimed Water only for the specific purpose specified herein; and

NOW THEREFORE, in consideration of the mutual covenants set forth herein, the County hereby agrees to sell and Customer hereby agrees to purchase Reclaimed Water from the County, subject to the following terms and conditions:

2. DEFINITIONS

As used in this Agreement, the following initial capitalized terms shall have the following meanings:

Air Gap Separation: A physical break between a water supply pipe and a receiving pipe or vessel.

Class IV Reclaimed Water: Reclaimed Water meeting the water quality requirements identified in the Maryland Department of the Environment Guidelines for Use of Reclaimed Water Chapter 4 – Standards for Reclaimed Water, latest edition.

County Reclaimed Water Distribution System: The purple distribution lines from the Little Patuxent Wastewater Treatment Plant, pump stations, mains, residential and commercial connections, and any other parts or components which comprise the Reclaimed Water system of the County, which is managed and operated by the Howard County Department of Public Works.

Cross-Connection to Potable Water: Unprotected actual or potential connection between a Potable Water system and any source or system containing non-Potable Water or other substance. By-pass arrangements, jumper connections, removable sections, swivel or changeover devices, or other devices through which backflow could occur are considered to be cross-connections.

Cross-Connection to Reclaimed Water: Unprotected actual or potential connection between a Reclaimed Water system and any source or system containing non-Potable Water or any substance that will reduce the quality of the Reclaimed Water. By-pass arrangements, jumper

connections, removable sections, swivel or changeover devices, or other devices through which backflow could occur are considered to be cross-connections.

Customer: Person or entity utilizing treated wastewater for agricultural, domestic, commercial or industrial purposes but does not originally treat the domestic wastewater.

Customer Agreement: Agreement or contract between the County and the Customers having Reclaimed Water service connections for monitoring and managing Reclaimed Water.

Customer's Facility: The facility owned by Customer and designated as the location to receive and utilize the Reclaimed Water under this Agreement.

MDE: Maryland Department of the Environment, an agency of the state of Maryland.

Potable Water: Water meeting the requirements of the MDE for human consumption and other domestic uses.

Reclaimed Water: Treated wastewater from the Little Patuxent Wastewater Treatment which has been treated to a quality suitable for beneficial use.

Reclaimed Water Manager: The individual employed by the County and designated as the County's contact person under this Agreement. The name and contact information is: Amy Hart, _____, 410-313-2723, ahart@howardcountymd.gov.

Reclaimed Water Supervisor: The individual employed by the Customer and designated as the Customer's contact person under this Agreement. The name and contact information is: _____.

Surface Waters: Water from rain, melting snow, springs, or seepage that lies or flows on the surface of the earth, including a watercourse, lake, or tidewater.

Any other words or phrases relating to the use of Reclaimed Water in this Agreement shall have the same definitions as those given under MDE's *Guidelines for Land Application / Reuse of Treated Municipal Wastewaters*, Draft April 2010.

3. DELIVERY OF RECLAIMED WATER

The County shall deliver Reclaimed Water from a meter or meters owned and maintained by the County. The approximate location of the Reclaimed Water meter is shown on Exhibit A – Application for Receiving Reclaimed Water Service.

The County does not guarantee to deliver the Reclaimed Water to Customer at any specific operating pressure.

The County shall have the right at any time, without notice, to shut off the delivery of Reclaimed Water for the purpose of making repairs or extensions, or for other necessary purposes. The Customer agrees the County shall not be held liable for any damage resulting from low pressure or high pressure, normal fluctuations of pressure, or interruptions of service of delivery of Reclaimed Water.

Customer hereby agrees and accepts the possibility that the County may be required to disrupt Reclaimed Water service to the Property due to emergency conditions, peak demands, or planned system maintenance. Customer shall be responsible for any damage that may be caused to Customer-owned facilities by such disruptions. In the event of any unforeseen emergency relating to the public Reclaimed Water delivery system, the County may terminate delivery of Reclaimed Water to the Property without prior notice to Customer. Whenever the County provides Customer

with notice of an emergency, Customer agrees to reduce or cease usage of Reclaimed Water service upon the County's request. In order to accommodate peak demand periods or planned maintenance of the public Reclaimed Water delivery system, the County shall provide Customer with at least twenty-four (24) hour notice of the need to completely cease Reclaimed Water usage, or to reduce the volume of Reclaimed Water used at the Property. Upon receiving such notice, Customer shall alter Customer's Reclaimed Water usage in accordance with the County's request.

In case of emergency repairs or other necessary work, or whenever the public health or safety so demands, the County may change, reduce, or limit the time for, or temporarily discontinue the supply of Reclaimed Water. Before so changing, reducing, limiting or discontinuing the supply of Reclaimed Water, the County shall, insofar as practicable, notify all Reclaimed Water consumers affected. The County shall not be responsible for any damage resulting from interruption or change of the Reclaimed Water supply, or for any damages incurred by the Customer arising out of the use or transportation of the Reclaimed Water.

If by reason of Force Majeure, the County shall be rendered unable wholly or in part to carry out its obligations under this Agreement to deliver Reclaimed Water, it shall not be required to deliver Reclaimed Water, and its failure to deliver Reclaimed Water in accordance with the terms and conditions of this Agreement, shall not be considered a breach of this Agreement. The term "Force Majeure" as used in this Agreement shall mean acts of God, strikes, lock-outs, or other industrial disturbances, acts of the public enemy, orders of any kind of the federal or state government, or any civil or military authority, insurrection, riots, epidemics, landslides, lightning, earthquakes, fires, hurricanes, storms, floods, washouts, droughts, power failures, arrests, restraint of government and people, civil disturbances, explosions, breakage or accidents to machinery, pipelines, the partial or entire failure of the Howard County Reclaimed Water System, unsuitable Reclaimed Water quality, or other causes.

Delivery of Reclaimed Water is subject to conditions identified in this Agreement. Customer agrees to accept such conditions of water pressure or service as may from time to time exist and to hold the County harmless on account of damage, if any, caused by low or high pressure, fluctuations of pressure or interruptions or curtailment of service.

4. USE OR APPLICATION OF RECLAIMED WATER

Prior to the delivery of Reclaimed Water, the County and the Customer shall complete an inspection of the Customer's facilities. All on-site modifications recommended by the County must be completed to the County's satisfaction prior to the delivery of the Reclaimed Water. In no event shall such service begin prior to the County's inspection of Customer's on-site Reclaimed Water storage and use system in order to verify compliance with all applicable requirements for the storage and use of Reclaimed Water.

The County will notify Customer at least thirty (30) days written notice of its intent to commence delivery of Reclaimed Water to the Customer's facilities.

Customer hereby certifies that the use of the Reclaimed Water is limited to the use and site set forth in Exhibit A.

5. CUSTOMER'S ON-SITE FACILITY MODIFICATIONS

The Reclaimed Water Program Manager shall review and comment on any required modifications to the Customer's Facility for the use of Reclaimed Water. All modification shall be approved by the Reclaimed Water Manager before construction commences.

The Customer shall install the necessary backflow prevention equipment to prevent Cross-connections with Reclaimed Water.

All modifications required in Customer's on-site facilities shall be the sole cost and responsibility of Customer. It shall be Customer's responsibility to construct the modifications in accordance with the approved plans and specifications, and pursuant to all permits and applicable laws and regulations.

Upon completion of all on-site modifications, Customer's Reclaimed Water and Potable Water systems, Customer shall provide the County with as-built drawings of Customer's completed Reclaimed Water system and Potable Water system on Customer's site. The drawings shall show at a minimum, the locations of all pipelines, controllers, valves, buildings, structures, property boundaries, and any other features important to the onsite use of Reclaimed Water.

The County shall install and maintain a Reclaimed Water meter on the Customer's site as required to monitor the Reclaimed Water deliveries made to Customer. Customer shall provide the County with any easements necessary for delivery of Reclaimed Water to Customer's premises at a mutually agreeable location. It is understood that the meter is the property of the County and that the Customer assumes all responsibility for any damage to, or loss of, the meter set to serve its property, and agrees to pay the County for any damages or loss.

6. INSPECTION

Customer acknowledges and agrees that, in order to verify compliance with this Agreement and with all applicable laws and regulations of the appropriate agencies of the County or the state of Maryland may inspect the Customer's facilities being served Reclaimed Water at all reasonable times. Customer hereby grants to such agencies, acting through their duly authorized employees, agents, or contractors, access at all reasonable times to enter the site for the purpose of observing construction or modification of Reclaimed Water facilities, for maintaining and repairing the Reclaimed Water facilities, for meter reading, and for observing and verifying that Customer is properly operating its Reclaimed Water facilities in accordance with the terms and conditions of this Agreement. When entering Customer's premises, the inspectors shall not unreasonably interfere with Customer's operations and its use of the premises.

7. MONITORING AND REPORTING

The Customer and the County will conduct periodic monitoring for the purpose of ensuring that the standards in this Agreement are being met at Reclaimed Water use sites. The County will provide monitoring reports annually to Customers addressing any needed improvements to comply with the standards listed in this Agreement.

8. QUALITY OF RECLAIMED WATER

Customer understands that Reclaimed Water is non-Potable Water. Customer understands and agrees that the quality of the Reclaimed Water is different from that of Customer's Potable Water supply and that Customer's practices or processes may have to be altered as a result.

Customer understands and agrees that the County provides the Reclaimed Water with no assertion or warranty as to the quality of the Reclaimed Water.

9. RECLAIMED WATER SUPERVISOR

Customer shall designate an individual as Customer's Reclaimed Water Supervisor. The Reclaimed Water Supervisor shall be Customer's coordinator and the direct contact person between County and the Customer. The Customer agrees that the Reclaimed Water Supervisor shall be responsible for the proper operation of Customer's Reclaimed Water system, implementing the requirements of this Agreement relative to the on-site use of Reclaimed Water, monitoring of Customer's Reclaimed Water system for prevention of potential hazards, and coordination with the County and other regulatory agencies. The County will assist in the training of Customer's

Reclaimed Water Supervisor as time and resources permit; however, it shall be the non-delegable responsibility of Customer to assure its Reclaimed Water Supervisor is trained in the use and handling of Reclaimed Water in accordance with all applicable rules, regulations and laws.

Customer shall complete Exhibit A – Application for Receiving Reclaimed Water Service. Customer shall inform the County in writing of the name, position, and day-time and night-time telephone numbers of Customer's Reclaimed Water Supervisor and shall promptly inform the County in writing of any changes of the person so designated or the person's contact information during the term of this Agreement.

10. OPERATIONAL REQUIREMENTS

The following use requirements are intended to satisfy the requirements of the Maryland Department of the Environment for the safe use of Reclaimed Water, per the Maryland Department of the Environment Guidelines for Land Application/Reuse of Treated Municipal Wastewaters:

A. Runoff and Spray Control:

1. Customer's Facility shall be managed so that public contact with Reclaimed Water shall be minimized.
2. Runoff of Reclaimed Water and spray shall be minimized.
3. Drinking water facilities and swimming pools shall be protected from Reclaimed Water spray.
4. Adequate measures shall be taken to minimize ponding of Reclaimed Water.
5. Reclaimed Water shall not be discharged or released to any Surface Water or storm water collection or conveyance facility.
6. Reclaimed Water use, including runoff and spray, shall be confined to the Customer's Facility designated in this approved Customer Agreement.
7. Customers using Reclaimed Water for irrigation must ensure that their irrigation systems are in good working order, maintained regularly, kept free of leaks, and are set so that Reclaimed Water is applied appropriately to the landscape, to avoid excessive puddling or runoff of Reclaimed Water. Sprinkler heads should be adjusted regularly to avoid application of Reclaimed Water to impervious services.

B. Notification:

1. Signs in both English and Spanish shall be provided at main entrances to the Customer's Facility and at Reclaimed Water hose bibs and faucets to inform the public that Reclaimed Water is being used.

C. Piping:

1. Above-ground Reclaimed Water facilities shall be marked by authorized methods to differentiate the Reclaimed Water facilities from the Potable Water facilities. Below-ground Reclaimed Water facilities shall be similarly marked if newly constructed or if exposed for repair.
2. Reclaimed Water valves, outlets, quick couplers and sprinklers shall be of a type, or secured in a manner, that permits operation only by Customer's authorized personnel.

3. For new underground construction, there shall be at least a 10-foot horizontal and 1-foot vertical separation between all pipelines transporting Reclaimed Water and those transporting Potable Water, with the Potable Water pipeline above the Reclaimed Water pipeline.
4. A backflow prevention device shall be provided at all Potable Water service connections in Customer's Facility utilizing Reclaimed Water. Backflow prevention devices must be installed, maintained and tested in accordance with the County's current cross connection control plan. There shall be no connection between Potable Water and Reclaimed Water piping. Supplementing Reclaimed Water with any Potable Water shall not be allowed except through an air-gap separation.
5. All valves of any type installed below grade (including existing valve boxes) shall be housed in a valve box with a purple locking cover.
6. All Reclaimed Water piping, valves, outlets and other appurtenances shall be color-coded purple, taped purple, or otherwise marked to identify the source of the water as being Reclaimed Water consistent with state Standards.

D. Training:

1. Inspection, supervision and employee training shall be provided by Customer to assure safe and proper operation of the Reclaimed Water system.
2. The Reclaimed Water Supervisor designated in Exhibit A – Application for Receiving Reclaimed Water Service of this Agreement shall ensure that all personnel using Reclaimed Water complete training in requirements for appropriate use of the Reclaimed Water. This training requirement may be met by: 1) familiarizing them with the terms of this service agreement, and 2) providing written materials provided by the County and discussing them with the employee(s).

E. Transfer:

1. Customer may not assign or transfer its rights under this Agreement. If a new person desires to utilize the Reclaimed Water provided under this Agreement, such person must contact the County and enter into a new agreement with the County.

11. NOTIFICATION OF PUBLIC

The Customer shall provide proper notification to Customer's employees and to the public that Reclaimed Water is being used at the Customer's Facility in accordance with applicable laws and regulations.

12. INDEMNITY

The Customer agrees to indemnify, defend and hold harmless the County, and its officers, agents, servants, employees from all suits, actions, losses, damages, claims, or liability, penalties and expenses of any character, type or description, including, without limitation, any fines, penalties and costs or damages whatsoever growing out of any action taken by any governmental entity or regulatory authority, department or agency of any governmental entity or any other person, including citizen suits, against the County for alleged noncompliance with laws, rules or regulations, whether relating to the environment or otherwise and including, without limiting the generality of the foregoing, all expenses of litigation, court costs, attorneys' fees, damages for injury, death or property damage sustained by any person or persons arising out of or occasioned by the acts of Customer, its officers, agents, employees or representatives or Customer's breach of the terms and conditions of this Agreement.

13. ENFORCEMENT

When the County finds that the Customer is not meeting the requirements of this Agreement, the County will notify the Customer in writing of its findings of non-compliance. Customer shall respond to the County with a Site Improvement Plan to include a schedule of time needed to address and resolve non-compliance issues. Unless otherwise approved by the County, Customer will have ___ days from the date the County notifies Customer of non-compliance in writing to implement the Site Improvement Plan measures.

14. PRICE AND PAYMENT FOR USE OF RECLAIMED WATER

The rate to be paid by Customer for Reclaimed Water delivered by the County under this Agreement shall be the standard rate that is applicable to that class of water and that class of Customer in effect at the time, date, and place of delivery, all as set forth in the Howard County Code. Nothing herein shall excuse Customer from payment of service or other charges as are applicable to the time, place, or manner of service and delivery.

The County shall read the Reclaimed Water meter at least quarterly consistent with the County's normal meter reading schedule for billing purposes and shall bill Customer for the total quantity delivered during the billing period in accordance with the County's standard billing practices.

The Customer and the County shall maintain records of the date and amount of Reclaimed Water delivered to Customer by the County.

Any costs arising out of the delivery to use of Reclaimed Water by Customer and from the construction, maintenance, or operation of the Reclaimed Water delivery system at the Customer's Facility shall be the sole responsibility of Customer.

Payments of bills shall be made to the County's Department of Finance each quarter on or before the due date. Amounts due for prior unpaid service will be transferred to active account. The County shall have the right to impose service charges on accounts that become delinquent or which incur in additional expenses.

The Customer will pay for all service received including Reclaimed Water consumption and charges as determined by all Reclaimed Water passing from the utilities meter to said premises from turn-on date, regardless whether Reclaimed Water is used or wasted, or whether premises are occupied by the Customer or not.

The County reserves the right, without notice to the Customer, to discontinue the service for the non-payment of any part of any bill or bills, for the violation of any part of the County's Plumbing Code, for transferring any of the Reclaimed Water delivered to the Customer's Facility, or for any uncured violation of this Agreement.

15. RESALE OF RECLAIMED WATER

Customer shall not, without the express written permission of the County and the Maryland Department of the Environment (MDE), deliver, use, or resell to off-site locations or to any person or legal entity, any of the Reclaimed Water delivered to the Property under this Agreement. Any such off-site delivery, use, or resale of Reclaimed Water purchased by Customer under this Agreement shall be made pursuant to a written resale agreement. Said resale agreement shall be approved in advance and in writing by the MDE and by the County. Said resale agreement shall incorporate this Agreement by reference, and shall expressly obligate the resale purchaser/user of Reclaimed Water to all of the terms and conditions set forth and referenced herein.

16. COMPLIANCE WITH REGULATIONS

Customer agrees, at its sole cost and responsibility, to comply with all applicable Federal, State and local laws, regulations and standards, as now exist, and are later lawfully enacted relating to the use of Reclaimed Water. Such laws, regulations, and standards may include, but not be limited to, requirements and restrictions governing use of Reclaimed Water; limits on Reclaimed Water contact with residents, guests, invitees, employees, members of the public, and adjoining properties; control of access to Reclaimed Water, its delivery system, and the area of storage and use; and warning signs on Customer's Reclaimed Water delivery system, and in the area of on-site storage and use of Reclaimed Water on the Property.

The Customer or the Customer's designee shall:

- Use application methods that reasonably preclude human contact with Reclaimed Water;
- Prevent Reclaimed Water from standing on open access areas during normal periods of use;
- Prevent Reclaimed Water from coming into contact with drinking fountains, water coolers, or eating areas;
- Secure hose bibs discharging Reclaimed Water to prevent use by the public.

If the Customer intends to discharge used or excess Reclaimed Water to any location other than the sanitary sewer or a dedicated Reclaimed Water return line, then the Customer shall obtain an NPDES permit.

The use of Reclaimed Water is regulated by the Maryland Department of the Environment Guidelines for Use of Reclaimed Water, latest edition. Customer shall fully inform itself of applicable requirements for the use of Reclaimed Water and abide by all laws and regulations governing Reclaimed Water use.

The Customer's use of Reclaimed Water will meet all applicable requirements contained in the Maryland Department of the Environment Guidelines for Use of Reclaimed Water Chapter 4 – Standards for Reclaimed Water, latest edition, as amended from time to time, or contained in any successor standards or ordinances.

Violations of these Terms and Conditions or of State standards and regulations may result in termination of Reclaimed Water service under this Agreement. Delivery of Reclaimed Water may, at County's sole discretion, be terminated for violation of the regulations or agreement.

17. TERM, RENEWAL, AND TERMINATION

The primary term of this Agreement is __ years from its date of execution by the County and the Customer. Thereafter, unless prior written notice is provided to the County by the Customer notifying the County of its intention to not renew, this Agreement shall be automatically renewed for a __ year term. Any such renewal of this Agreement shall be subject to any changes in its terms and conditions required to comply with federal, state, and local laws and regulations or deemed necessary by the County or desirable by the parties.

The County may terminate this Agreement if the County, at its sole determination, is or will be unable to deliver properly and adequately treated Reclaimed Water to Customer for any reason whatsoever for a period greater than thirty (30) days, or, the County, at its sole determination, determines that Customer is unable to adequately control the use of Reclaimed Water in accordance with this Agreement.

Either Party to this Agreement may terminate this Agreement before its expiration date with or without cause by giving the other Party at least thirty (30) days written notice. The County may terminate this Agreement at any time if the Customer fails to comply with the terms and conditions of this Agreement.

18. GENERAL CONDITIONS

This Agreement shall be construed and interpreted in accordance with the laws of the State of Maryland, and venue of any litigation hereunder shall be in a court of competent jurisdiction sitting in Howard County, Maryland.

This Agreement and the Exhibits hereto contain all the agreements of the parties with regard to this Agreement and cannot be enlarged, modified or changed in any respect except by written agreement between the parties.

The unenforceability, invalidity or illegality of any provisions of this Agreement shall not render the other provisions unenforceable, invalid or illegal, but the parties shall negotiate as to the effect of said unenforceability, invalidity or illegality on the rights and obligations of the parties.

The County and Customer will each use their best efforts to fully cooperate with one another as may be necessary to diligently obtain and maintain in effect any required permits and all other approvals and records required by regulatory requirements that may be necessary for the County and Customer to perform under, or take advantage of, the terms and conditions of this Agreement.

Notices to be given by either party to the other relative to this Agreement shall be in writing. Both parties agree that any such notice shall be effective when personally delivered or deposited, postage paid, in the U.S. Mail addressed by certified mail, return receipt request, as follows:

County: Howard County Department of Public Works
Bureau of Utilities
Reclaimed Water Manager
8250 Old Montgomery Road
Columbia, MD 21045

Customer: _____
Reclaimed Water Supervisor

This Agreement is for the sole and exclusive benefit of the parties hereto and shall not be construed to confer any rights upon any third party. Nothing herein shall be construed to confer standing upon any third party who did not otherwise have such standing.

All leases, sales and other conveyances or transfers of ownership or control of the Customer's Facility receiving the Reclaimed Water during the effective term of this Agreement shall be made in writing and shall be made expressly subject to this Agreement and shall require the new owner or lessee to enter into a new agreement with the County.

Customer's agreements with a third party for the management of the site shall not in any way relieve Customer of compliance with the terms of this Agreement.

19. SIGNATURES

I, the undersigned, do hereby affirm that I have the legal authority to enter into this Agreement for the Reclaimed Water service on behalf of the Customer identified above, that I have read the terms and conditions specified in this Agreement and references herein, and that the Customer identified

above agrees to and shall be bound by said terms and conditions for the use of such water as specified in this Agreement and the references herein:

IN WITNESS WHEREOF, the County and Customer have executed this Agreement as of the date and year first written above.

Customer:

(Signature)

(Name, Title)

[Standard signature page of County will be inserted.]

Exhibit A – Application for Receiving Reclaimed Water Service

A. Customer:

1. Name of Customer
2. Relationship to Site (Legal Owner, Tenant, Lessee)
3. Legal Description of Property
4. Mailing Address of Customer (include City, State, and Zip Code)
5. Customer's Telephone Number
6. Customer's Fax Number
7. Customer's E-Mail
8. Address of Site for Reclaimed Water (include City, State, and Zip Code)

B. Reclaimed Water Supervisor:

1. Name of Reclaimed Water Supervisor
2. Mailing Address of Reclaimed Water Supervisor (include City, State, and Zip Code)
3. Reclaimed Water Supervisor's Telephone Number
4. Reclaimed Water Supervisor's Fax Number
5. Reclaimed Water Supervisor's E-Mail
6. Emergency Telephone Number

C. Reclaimed Water Use:

1. Intended Use(s):
 - Cooling / Cooling Tower
 - Manufacturing / Process
 - Fire Protection
 - Manufacturing / Cleaning
 - Maintenance / Cleaning
 - Irrigation (Landscape)
 - Irrigation (Agricultural)
 - Other, Explain
2. Average Daily Demand (gallons per day)
 - a. Winter (January - March) Average Daily Demand
 - b. Spring (April - June) Average Daily Demand
 - c. Summer (July - September) Average Daily Demand
 - d. Autumn (October - December) Average Daily Demand

3. Peak Flow Rate (gallons per minute)
4. Period of Use – Hours of the Day
5. Period of Use – Days of the Week
6. Period of Use – Months of the Year

Flow Lost to Consumptive or Evaporative Use

- a. Winter (January - March) Average Flow Lost to Consumptive or Evaporative Use
 - b. Spring (April - June) Average Flow Lost to Consumptive or Evaporative Use
 - c. Summer (July - September) Average Flow Lost to Consumptive or Evaporative Use
 - d. Autumn (October - December) Average Flow Lost to Consumptive or Evaporative Use
8. Disposal Plan for Excess or Used Reclaimed Water:

D. Site Information:

1. Attach Sketch of Property including the following information:
 - a. Fronting Street and Nearby Intersection
 - b. Location(s) of Use on Property
 - c. Location of Reclaimed Water Meter (Based on Information provided by Howard County)
 - d. Location and Size of All Reclaimed Water Piping on Site
 - e. Location of All Connections (Hose Bibs / Spigots / Faucets, Hydrants, and all other Outlets)
 - f. Location(s) of Any Water Supply Wells (Potable or Non-Potable) on Property
 - g. Provide Distance from Water Supply Well to Nearest Reclaimed Water Outlet

Upon approval by Howard County, the County will issue a Reclaimed Water Permit Number that the Customer shall reference in all correspondence

Appendix B: Text on Reclaimed Water for Howard County Website

What is Reclaimed Water?

Reclaimed water is wastewater that has been treated to a standard that is higher than drinking water standards and reintroduced into the water cycle for reuse for non-potable purposes.

Where Does Reclaimed Water Come From?

The County's Little Patuxent Water Reclamation Plant (LP WRP) receives wastewater from approximately 70% of the County's Metropolitan District. The LP WRP treats the wastewater using the latest technologies to remove all pollutants and transform it back into pure water. At the end of the treatment process, the treated wastewater is discharged to the Little Patuxent River. Before being discharged, part of this flow is diverted to the County's reclaimed water system in order to get new life and be re-purposed.

Reclaimed Water Can Be Used For:

Reclaimed water is not potable (drinkable). However, it is appropriate for many other uses such as:

- Cooling – Air conditioning and cooling is an often overlooked but significant draw on the drinking water system. Reclaimed water can be used in cooling towers instead of drinking water.
- Manufacturing / Process – The number and types of industries with potential uses for reclaimed water is practically unlimited. Essentially any use where the water does not have to be potable and does not include human contact is a potential candidate for reclaimed water. Such users include producers of aggregates and concrete.
- Irrigation (Agricultural / Landscape) – Reclaimed water can be used for non-food product agricultural irrigation such as tree farms and sod farms, landscape / golf course irrigation, and filling decorative pools and fountains. Irrigation can account for very high flows especially during high demand periods such as during a drought.
- Other uses may be possible but each requires County review and approval on a case by case basis.

Using reclaimed water instead of drinking water can help reduce the strain on the drinking water system while still meeting the demands of customers.

Reclaimed Water Can Not Be Used For:

Reclaimed water is not applicable in all situations and is not approved for uses such as:

- Irrigation of Food Products
- Swimming Pools

Although reclaimed water is highly treated and disinfected, it is not approved for human consumption / ingestion or contact.

Why Reclaimed Water?

Using reclaimed water has a lot of benefits and is part of the County's overall effort in going green.

- Reclaimed water helps conserve water supplies. Using reclaimed water instead of drinking water reduces the demand on the drinking water system.
- Reclaimed water helps the environment. Using reclaimed water keeps it in the water cycle thus reducing wastewater treatment plant discharges to the environment.
- Reclaimed water reduces demands on infrastructure. In today's world of shrinking budgets, using reclaimed water lessens the burden to the drinking water system and the sewage treatment system by delaying or even eliminating some capacity needs.
- Reclaimed water saves money. Reclaimed water is a lower cost alternative to drinking water.

Conserving water, helping the environment, and relieving some of the pressure on the infrastructure, all while saving money.

Precautions

Reclaimed water is safe! However, using reclaimed water does not come without risks of exposure. Reclaimed water is a proven technology but as with all technologies, it has to be used in the right way. For precautionary reasons it is not approved for human contact and the County is taking the appropriate measures to prevent it:

- Reclaimed water is treated to a high standard and disinfected. The level of treatment actually exceeds that of drinking water requirements.
- Reclaimed water is approved for only limited types of uses, none of which involve significant potential for exposure to the public.
- The County screens customers applying for reclaimed water service to ensure that it will be used for only the approved purposes.
- The County requires each customer to enter into a legal agreement outlining the customer's obligations and holding them liable for any breaches.
- Reclaimed water utility piping is required to be designed and constructed to County standards.
- Before a customer can begin receiving reclaimed water, the County performs an initial inspection of the reclaimed water system piping on site in order to ensure that all requirements have been met.
- Even after a reclaimed water system has been approved and is in service, the County performs annual inspections of each existing reclaimed water customer in order to ensure that the requirements continue to be met.
- The County monitors reclaimed water usage rates in order to account for all flow.

Frequently Asked Questions

How do I know if reclaimed water is being used in an area?

Most places where reclaimed water use is applied are inaccessible to the public. However they are all posted with warning signs anyway.

What if I come into contact with reclaimed water?

Wash the affected area with soap and water from a drinking water faucet.

What if I have consumed some reclaimed water?

Although it is unlikely to be harmful, you should consult your physician as a precaution.

Is it OK if my pet drinks reclaimed water?

Howard County recommends that pets be provided with water from a drinking water faucet.

The Past is Prologue

The "Past": Reclaimed water is a proven technology. There is a long history dating back to the 1960's of municipalities across the country safely using reclaimed water.

The "Prologue": Howard County is a proactive leader in conserving water, helping the environment, and providing cost savings to its citizens. Reclaimed water is the future. Water is a valuable resource – make the most of it.

Request More Information / New Customers

Want more information or interested in receiving reclaimed water? Contact us:

Reclaimed Water Program Manager

Howard County Department of Public Works
Bureau of Utilities
Reclaimed Water Program Manager
8250 Old Montgomery Road
Columbia, MD 21045

Telephone: 410-313-____

E-Mail: ____@howardcountymd.gov

View our standard agreement which includes the Application for Receiving Reclaimed Water Service:

Reclaimed Water Utility Customer Agreement: _____

Resources

Links to Other Resources:

Howard County Master Plan for Water and Sewerage, 2011 Amendment: _____

Maryland Department of the Environment: _____

Environmental Protection Agency: _____

Where Does Reclaimed Water Come From?

The Little Patuxent Water Reclamation Plant which treats wastewater using the latest technologies to remove all pollutants and transform it back into pure water in order to get new life and be re-purposed.



“Reliable professionals delivering customer-focused water services.”

Howard County Bureau of Utilities

Howard County Department of Public Works
Bureau of Utilities
Reclaimed Water Program Manager
8250 Old Montgomery Road
Columbia, MD 21045



HOWARD COUNTY RECLAIMED WATER PROGRAM

Educational Pamphlet

Place
Postage
Here





What is Reclaimed Water?

- Wastewater that has been treated to a standard that is higher than drinking water standards and reintroduced into the water cycle for reuse for non-potable purposes. However even though reclaimed water is highly treated and disinfected, it is not approved for uses of human consumption / ingestion or contact.

Why Reclaimed Water?

- To help conserve water supplies by reducing the demand on the drinking water system.
- To help the environment by keeping reclaimed water in the water cycle thus reducing wastewater treatment plant discharges to the environment.
- To reduce demands on infrastructure by lessening the burden to the drinking water system and the sewage treatment system by delaying or even eliminating some capacity needs.
- To save money as it is a lower cost alternative to drinking water.

Precautions

- Reclaimed water is treated to a high standard and disinfected. The level of treatment actually exceeds that of drinking water requirements.
- Reclaimed water is approved for only limited types of uses, none of which involve significant potential for exposure to the public.
- The County screens customers applying for reclaimed water service to ensure that it will be used for only the approved purposes.
- The County requires each customer to enter into a legal agreement outlining the customer's obligations and holding them liable for any breaches.
- Reclaimed water utility piping is required to be designed and constructed to County standards.
- Before a customer can begin receiving reclaimed water, the County performs an initial inspection of the reclaimed water system piping on site in order to ensure that all requirements have been met.
- Even after a reclaimed water system has been approved and is in service, the County performs annual inspections of each existing reclaimed water customer in order to ensure that the requirements continue to be met.
- The County monitors reclaimed water usage rates in order to account for all flow.



Reclaimed Water Can Be Used For:

- Air conditioning, cooling systems, and cooling towers
- Manufacturing or process water for various industries
- Irrigation for landscape and non-food agricultural sites such as golf courses and tree farms
- Other uses upon County approval

Reclaimed Water *Can't* Be Used For:

- Drinking water as reclaimed water is not potable or drinkable
- Irrigation of food products
- Swimming pools

Contact Us

Howard County Department of Public Works
Bureau of Utilities
Reclaimed Water Program Manager
8250 Old Montgomery Road
Columbia, MD 21045
(P) 410-313-****
(F) 410-313-***
E-mail: _____@howardcounty.gov

Visit us on the web:
www.co.ho.md.us/reclaimedwater

HOWARD COUNTY RECLAIMED WATER PROGRAM

EDUCATIONAL PRESENTATION



WHAT IS RECLAIMED WATER?

- ▶ Wastewater that has been treated to a standard that is higher than drinking water standards and reintroduced into the water cycle for reuse for non-potable purposes.



WHERE DOES RECLAIMED WATER COME FROM?

- ▶ The Little Patuxent Water Reclamation Plant which treats wastewater using the latest technologies to remove all pollutants and transform it back into pure water in order to get new life and be re-purposed.

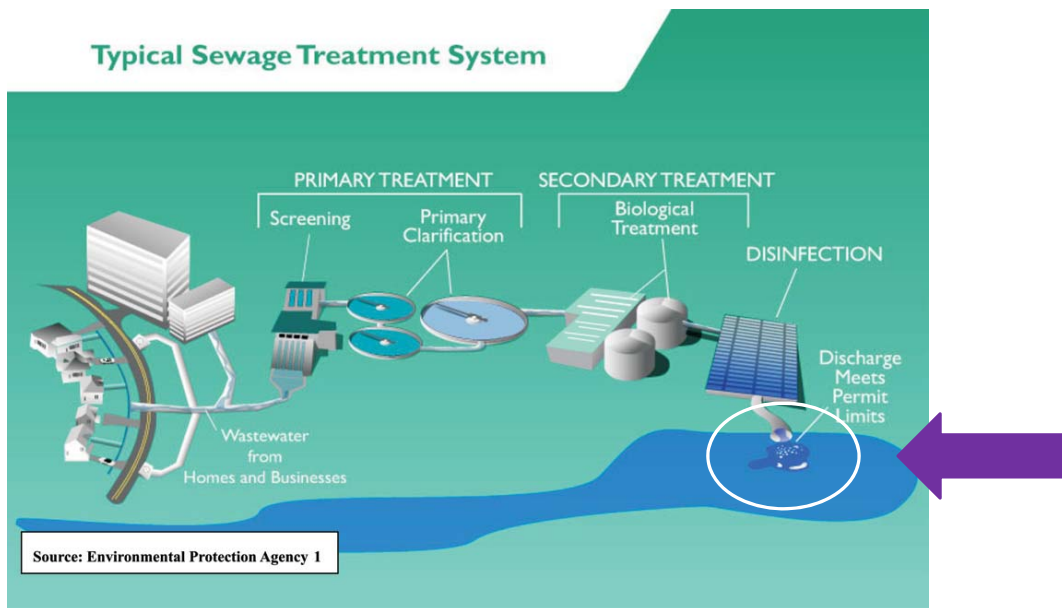

http://v2.mmsd.com/AssetsClient/Images/Wastewater%20Sect/treatment_process1_lq.jpg

RECLAIMED WATER CAN BE USED FOR:

- ▶ Air conditioning, cooling systems, and cooling towers
- ▶ Manufacturing or process water for various industries
- ▶ Irrigation for landscape and non-food agricultural sites such as golf courses and tree farms
- ▶ Other uses upon County approval



RECLAIMED WATER **CANNOT** BE USED FOR:

- ▶ Cooking or drinking
- ▶ Body contact recreation (swimming pools & spas)
- ▶ Irrigating vegetable & herb gardens (always wash produce, regardless of water source)

Although reclaimed water is highly treated and disinfected, it is not approved for human consumption / ingestion or contact.



WHY RECLAIMED WATER?

- ▶ Reclaimed water helps conserve water supplies. Using reclaimed water instead of drinking water reduces the demand on the drinking water system.
- ▶ Reclaimed water helps the environment. Using reclaimed water keeps it in the water cycle thus reducing wastewater treatment plant discharges to the environment.
- ▶ Reclaimed water reduces demands on infrastructure. In today's world of shrinking budgets, using reclaimed water lessens the burden to the drinking water system and the sewage treatment system by delaying or even eliminating some capacity needs.
- ▶ Reclaimed water saves money. Reclaimed water is a lower cost alternative to drinking water.



PRECAUTIONS

- ▶ Reclaimed water is treated to a high standard and disinfected. The level of treatment actually exceeds that of drinking water requirements.
- ▶ Reclaimed water is approved for only limited types of uses, none of which involve significant potential for exposure to the public.
- ▶ The County screens customers applying for reclaimed water service to ensure that it will be used for only the approved purposes.
- ▶ The County requires each customer to enter into a legal agreement outlining the customer's obligations and holding them liable for any breaches.
- ▶ Reclaimed water utility piping is required to be designed and constructed to County standards.
- ▶ Before a customer can begin receiving reclaimed water, the County performs an initial inspection of the reclaimed water system piping on site in order to ensure that all requirements have been met.
- ▶ Even after a reclaimed water system has been approved and is in service, the County performs annual inspections of each existing reclaimed water customer in order to ensure that the requirements continue to be met.

ADDITIONAL QUESTIONS?

- ▶ Howard County Department of Public Works
Bureau of Utilities
Reclaimed Water Program Manager
8250 Old Montgomery Road
Columbia, MD 21045

Telephone: 410-313-____
E-Mail: ____@howardcountymd.gov
- ▶ Visit us on the web: <http://www.howardcountymd.gov>

Appendix E: Reclaimed Water Warning Sign



Appendix F: Reclaimed Water Utility Initial and Annual Inspection Checklist

1. General

- a. Customer Name (Business or Individual for Private Systems):
- b. Customer Address:
- c. Reclaimed Water Permit Number:

2. Notification

- a. Notification at Public Entrance:
- b. Notification of Employees in Common Area:

3. Personnel

- a. Records of Employee Training:
- b. Confirmation of Employee Training:

4. Visual Inspection

- a. Reclaimed Water System Piping:
 - 1) Availability of Reclaimed Water System Piping As-Built Drawings:
 - 2) Visual Inspection of Reclaimed Water System Piping for Cross-Connection:
 - 3) Evidence of Reclaimed Water System Piping Cross-Connection to Potable Water System Piping:
 - 4) Air Gap or Backflow Preventer on All Reclaimed Water System Piping Outlets:
 - 5) Completeness and Correctness of Reclaimed Water System Piping As-Built Drawings:
 - 6) Reclaimed Water Piping & Appurtenances Marked Purple:
 - 7) Reclaimed Water System Hose Bibs / Spigots / Faucets, Hydrants / Outlets, Valves, & Appurtenances Labeled and Secured:
- b. Potable Water System Piping:
 - 1) Availability of Potable Water System Piping As-Built Drawings:
 - 2) Visual Inspection of Potable Water System Piping for Cross-Connection:
 - 3) Evidence of Potable Water System Piping Cross-Connection to Reclaimed Water System Piping:
 - 4) Air Gap or Backflow Preventer on All Potable Water System Piping Outlets:
 - 5) Completeness and Correctness of Potable Water System Piping As-Built Drawings:

c. Reclaimed Water Use / Site:

1) Reclaimed Water Use(s):

- Cooling / Cooling Tower
- Manufacturing / Process
- Fire Protection
- Manufacturing / Cleaning
- Maintenance / Cleaning
- Irrigation (Landscape)
- Irrigation (Agricultural)
- Other, Explain:

2) Evidence of Puddling or Overspray:

3) Ultimate Disposition of Reclaimed Water:

5. Cross-Connection Testing (National Standard Plumbing Code Illustrated Section G.4.3.11 Inspection and Testing)

a. Reclaimed Water System Depressurized and Drained / Potable Water System On-Line:

- 1) Potable Water System Checked for Flow – All Potable Water System Hose Bibs / Spigots / Faucets, Hydrants / Outlets Verified as ACTIVE:
- 2) Reclaimed Water System Checked for Flow – All Reclaimed Water System Hose Bibs / Spigots / Faucets, Hydrants / Outlets Verified as INACTIVE:

b. Potable Water System Depressurized and Drained / Reclaimed Water System On-Line:

- 1) Reclaimed Water System Checked for Flow – All Reclaimed Water System Hose Bibs / Spigots / Faucets, Hydrants / Outlets Verified as ACTIVE:
- 2) Potable Water System Checked for Flow – All Potable Water System Hose Bibs / Spigots / Faucets, Hydrants / Outlets Verified as INACTIVE:

6. Approval

a. Approval:

b. Corrective Actions Needed:

c. Inspector Comments:

d. Signature of Inspector:

e. Name of Inspector (Printed):

f. Signature of Customer Representative:

g. Name of Customer Representative (Printed):

h. Date of Inspection:

EXHIBIT 12

Howard County Topographic Map

HOWARD COUNTY

MASTER PLAN FOR WATER AND SEWER

TOPOGRAPHY

NOVEMBER 2015

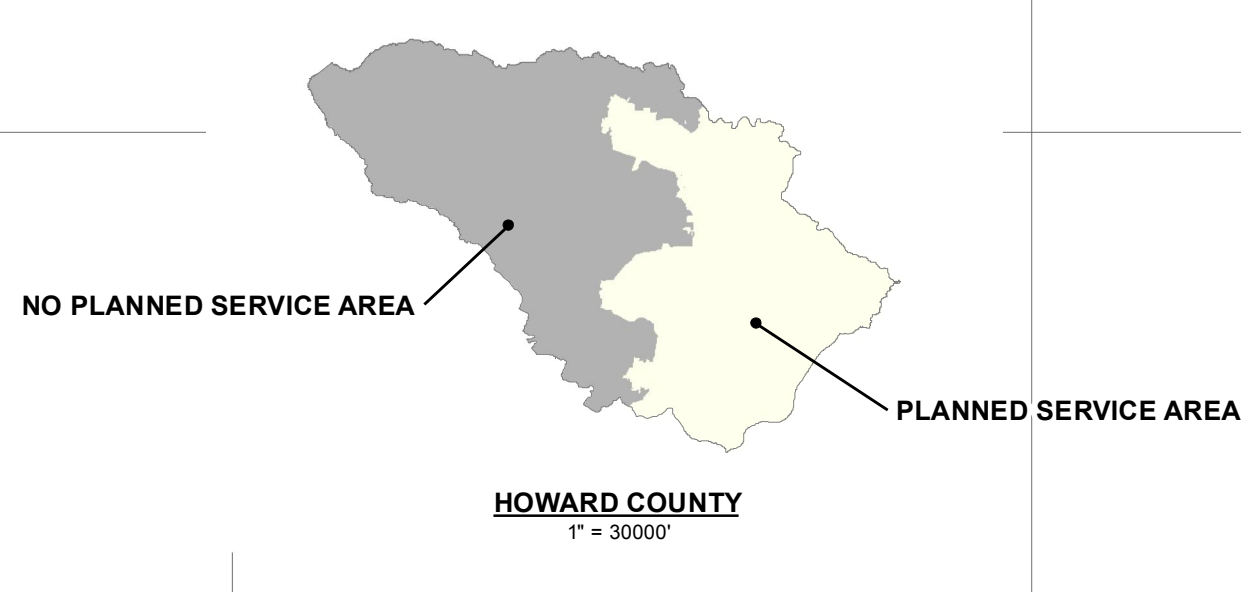

- 50' Contour
- Service Area
- No Planned Service
- Park/Open Space

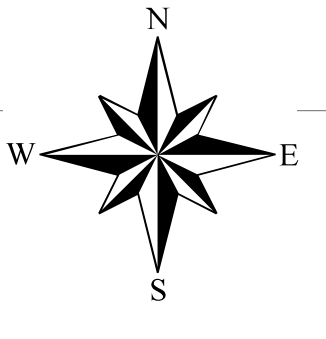

NOTE: BASE MAP DEVELOPED ON HOWARD COUNTY TAX MAPS

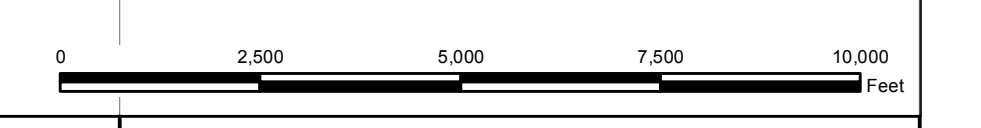
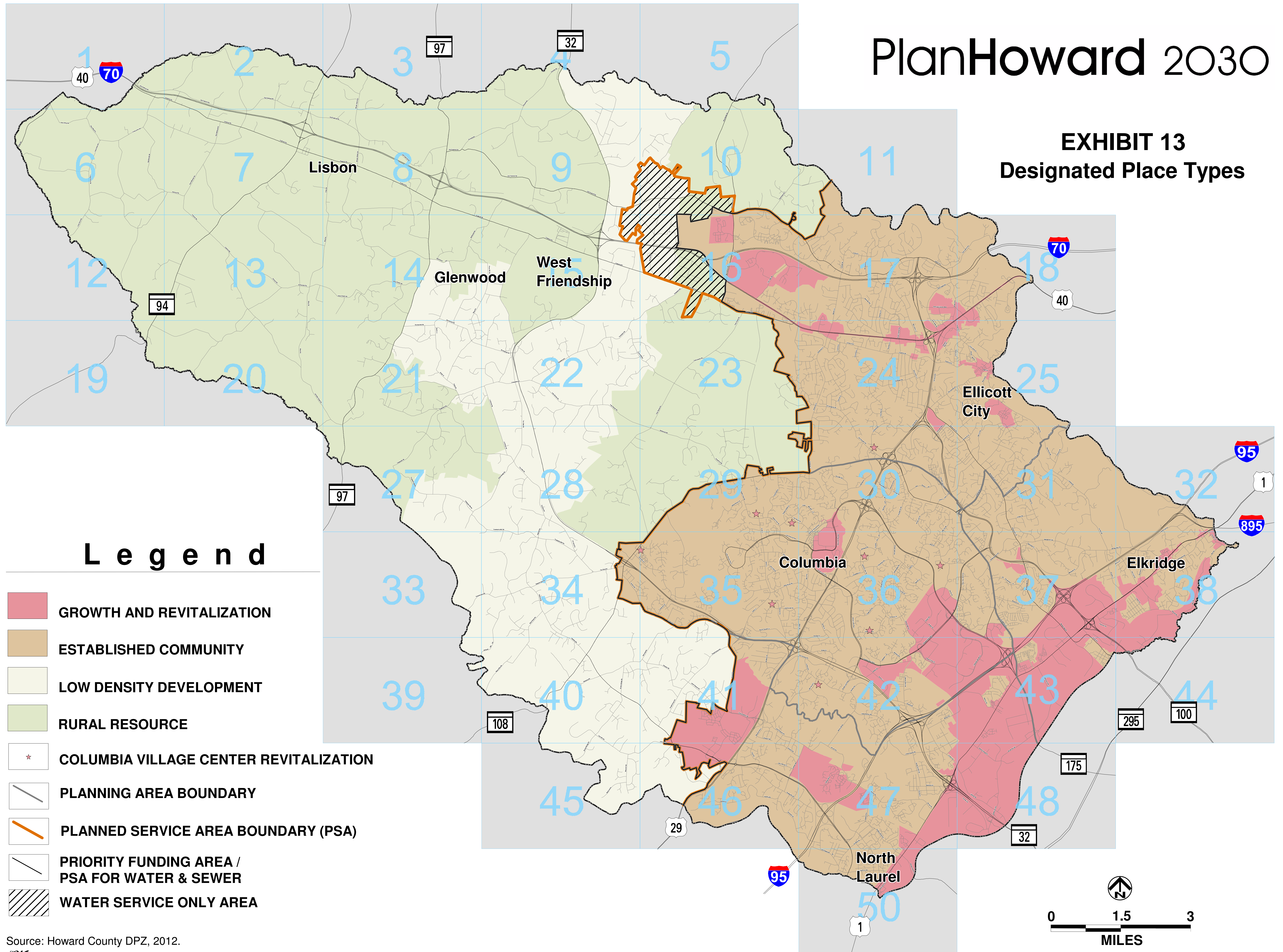

EXHIBIT 13



Howard County PlanHoward 2030 Map

PlanHoward 2030

EXHIBIT 13 Designated Place Types

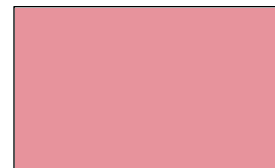
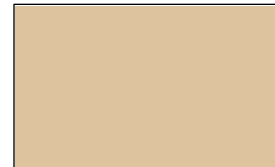

Legend

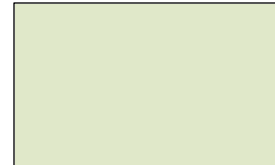
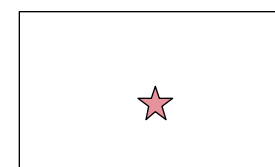
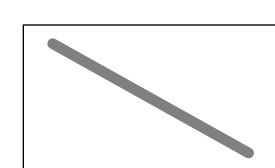
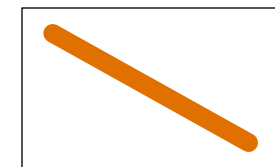
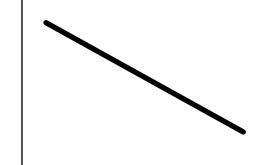
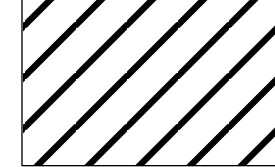
-  GROWTH AND REVITALIZATION
-  ESTABLISHED COMMUNITY
-  LOW DENSITY DEVELOPMENT
-  RURAL RESOURCE
-  COLUMBIA VILLAGE CENTER REVITALIZATION
-  PLANNING AREA BOUNDARY
-  PLANNED SERVICE AREA BOUNDARY (PSA)
-  PRIORITY FUNDING AREA / PSA FOR WATER & SEWER
-  WATER SERVICE ONLY AREA

